

NACRTNA GEOMETRIJA

predavanja 2021

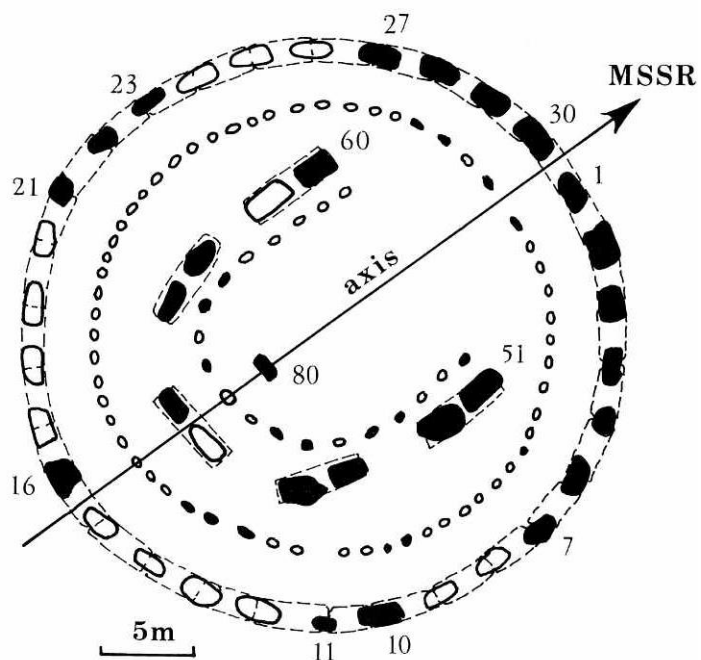

GEOMETRIJA JE SVUDA!

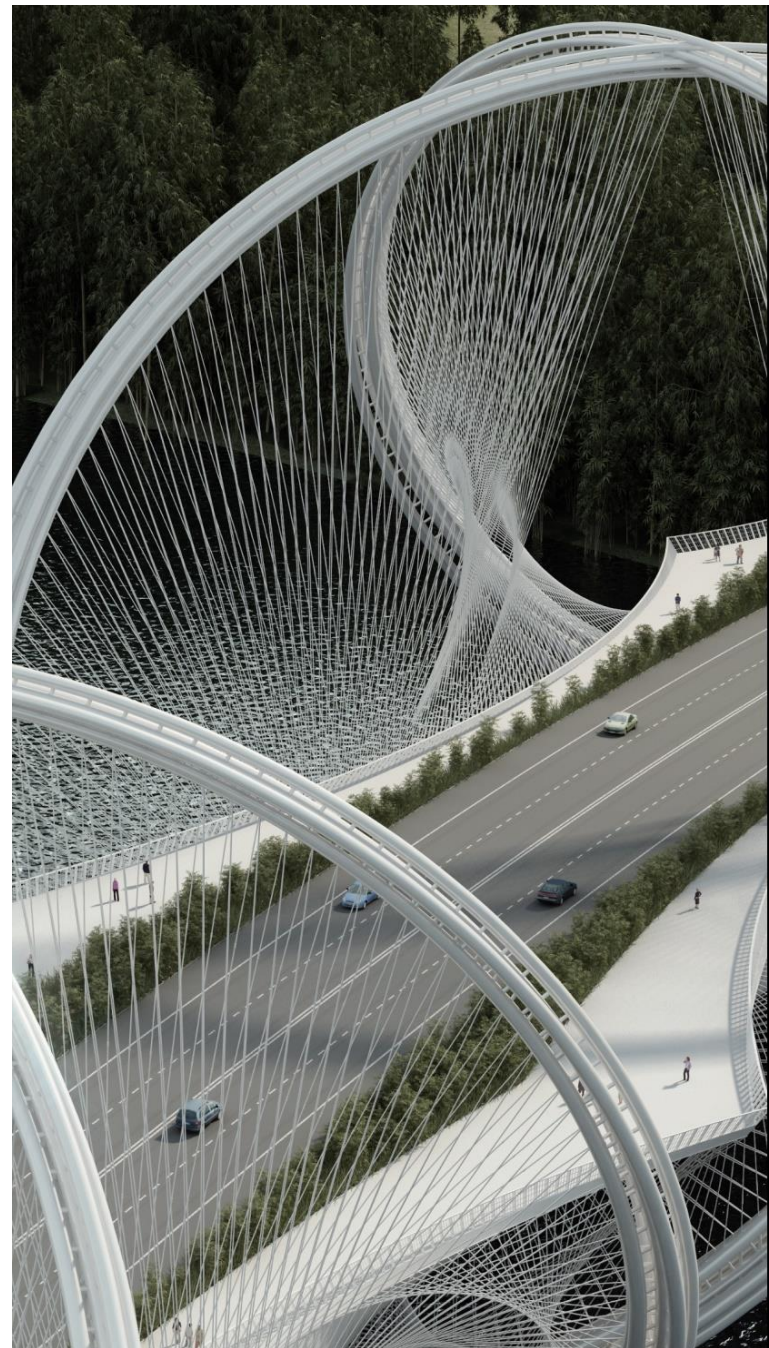

- Euklidska geometrija

OBNOVITI:

Osnovni geometrijski elementi i njihovi odnosi

Osnovne geometrijske konstrukcije i postupci

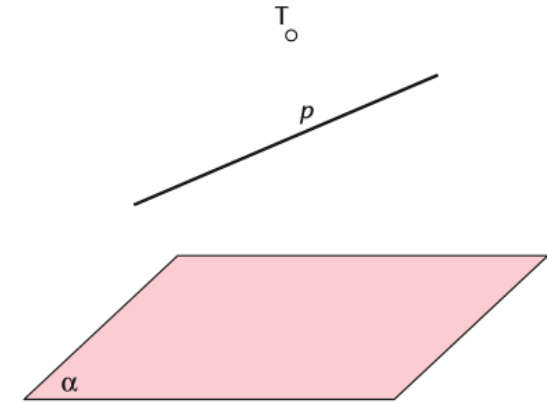

- Nacrtna (deskriptivna) geometrija XVIII v.

- Zašto je važna za inženjere?

- Projeciranje

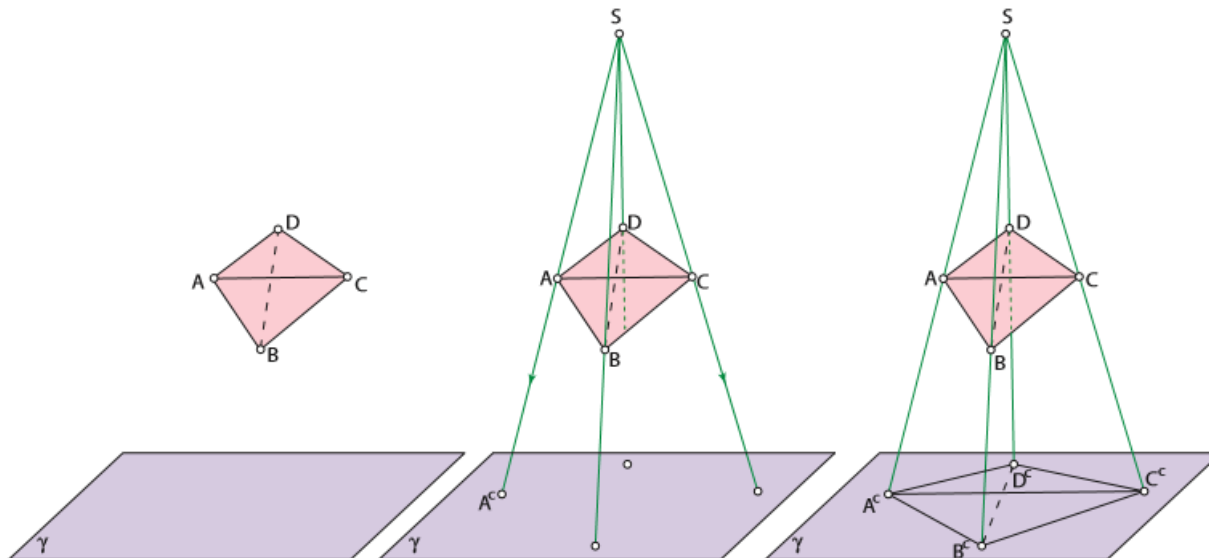

1. CENTRALNO PROJICIRANJE - PERSPEKTIVA

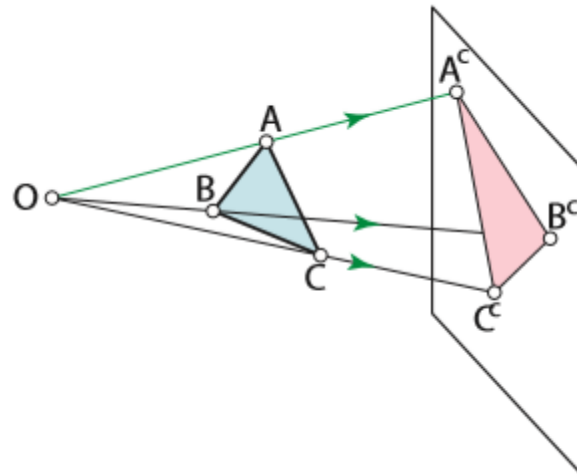

2. PARALELNO: koso – aksonometrija i ortogonalno

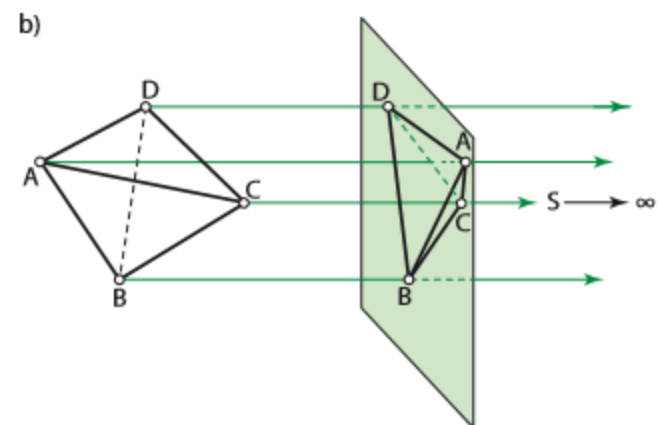
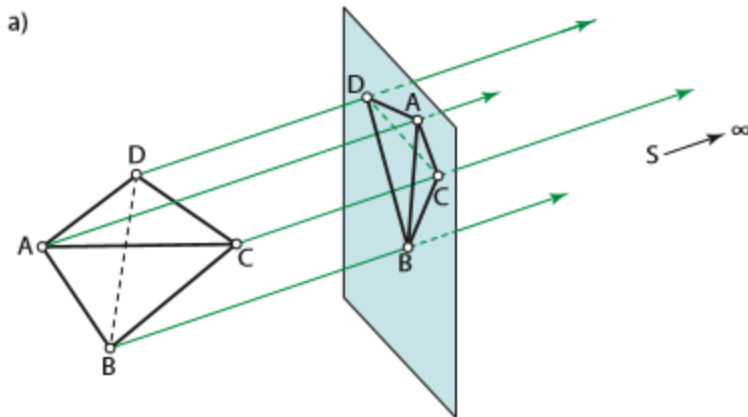

ORTOGONALNA PROJEKCIJA

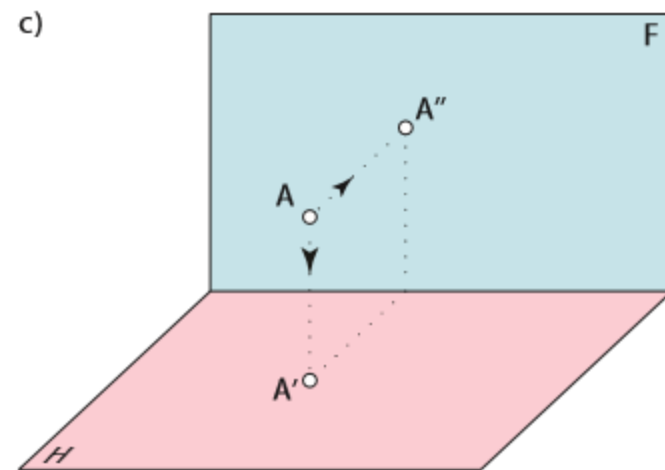
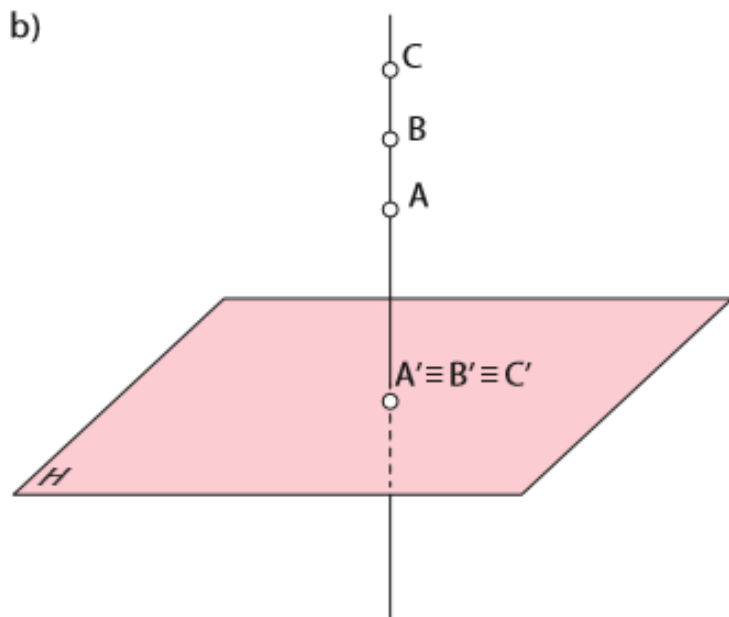
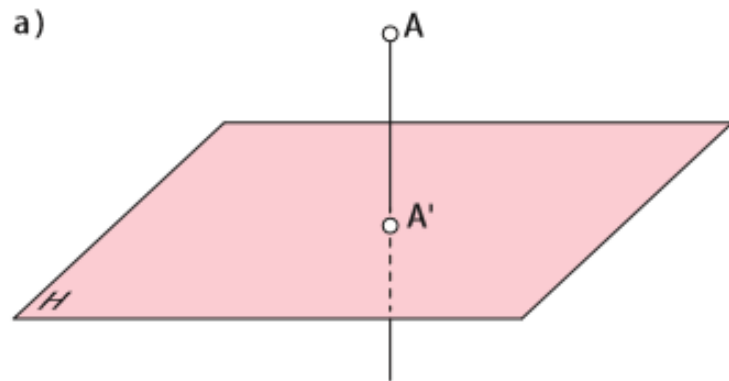

Slika B1.1. Projiciranje tačke na ravni H i F

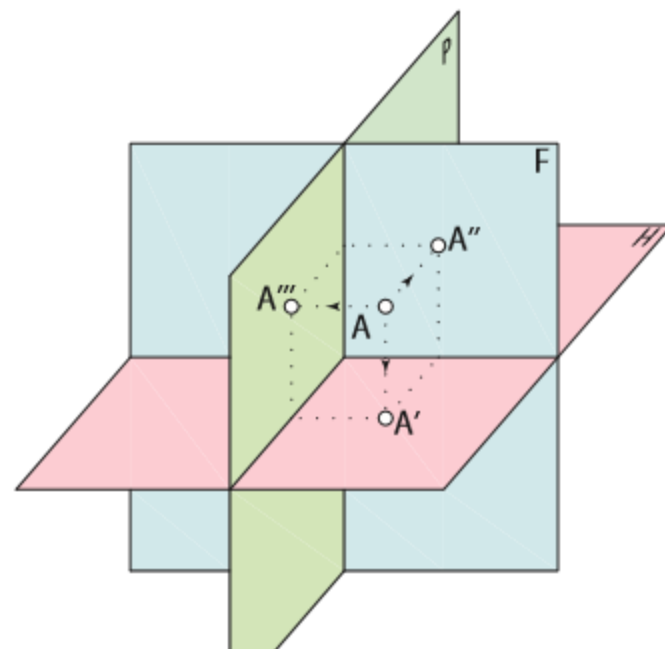

PRVA PROJEKCIJA TRIEDRA

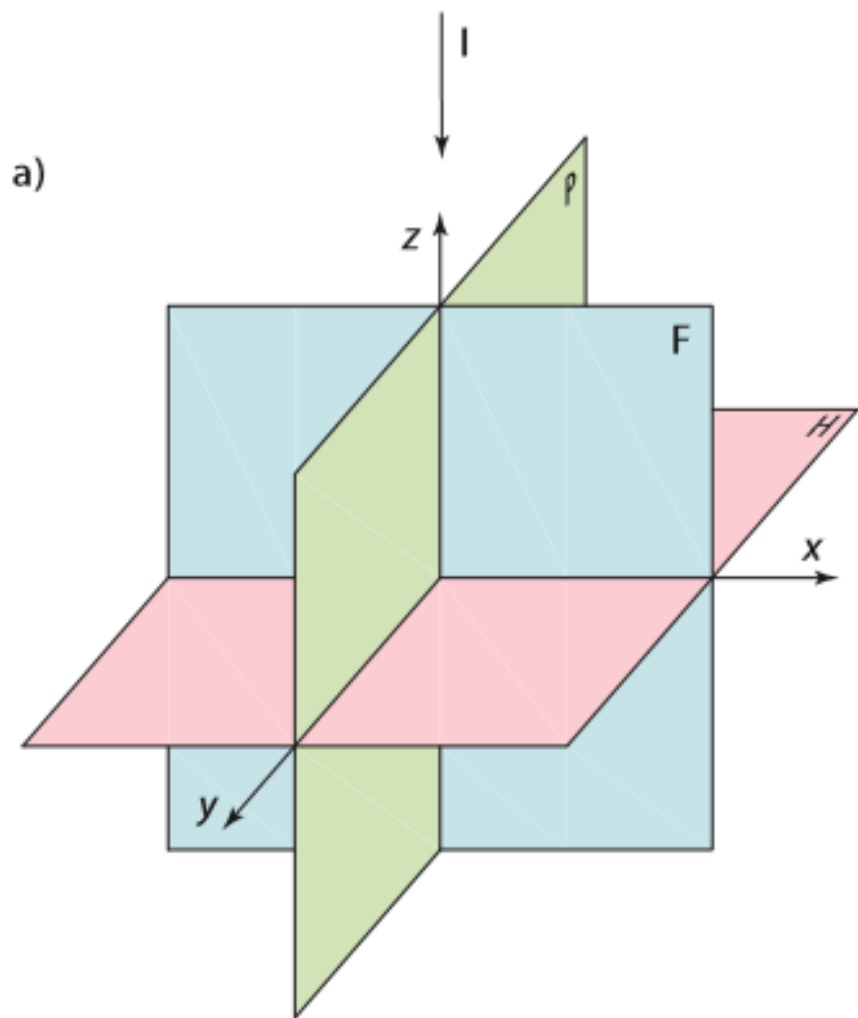

b)

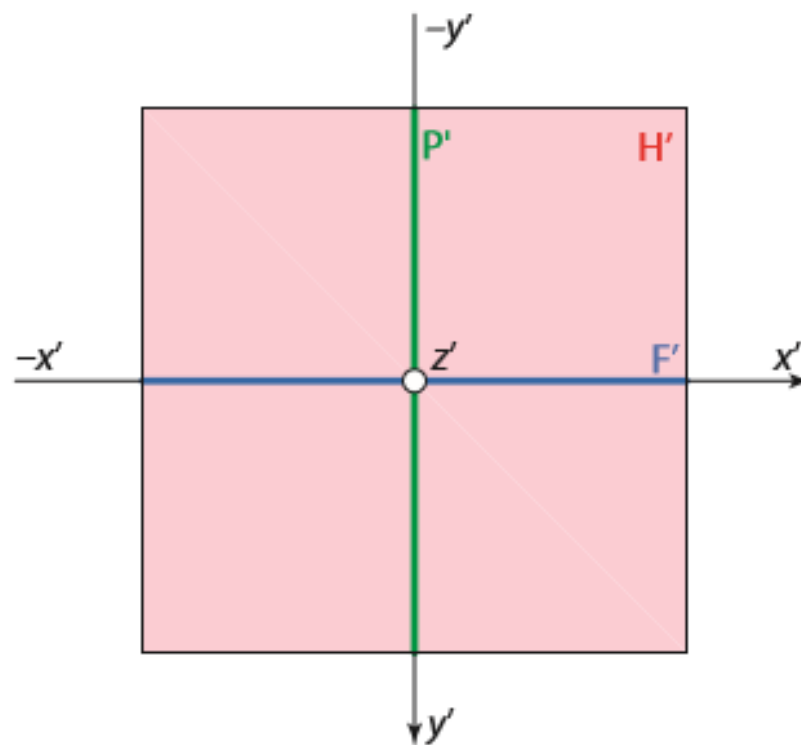

DRUGA PROJEKCIJA TRIEDRA

a)

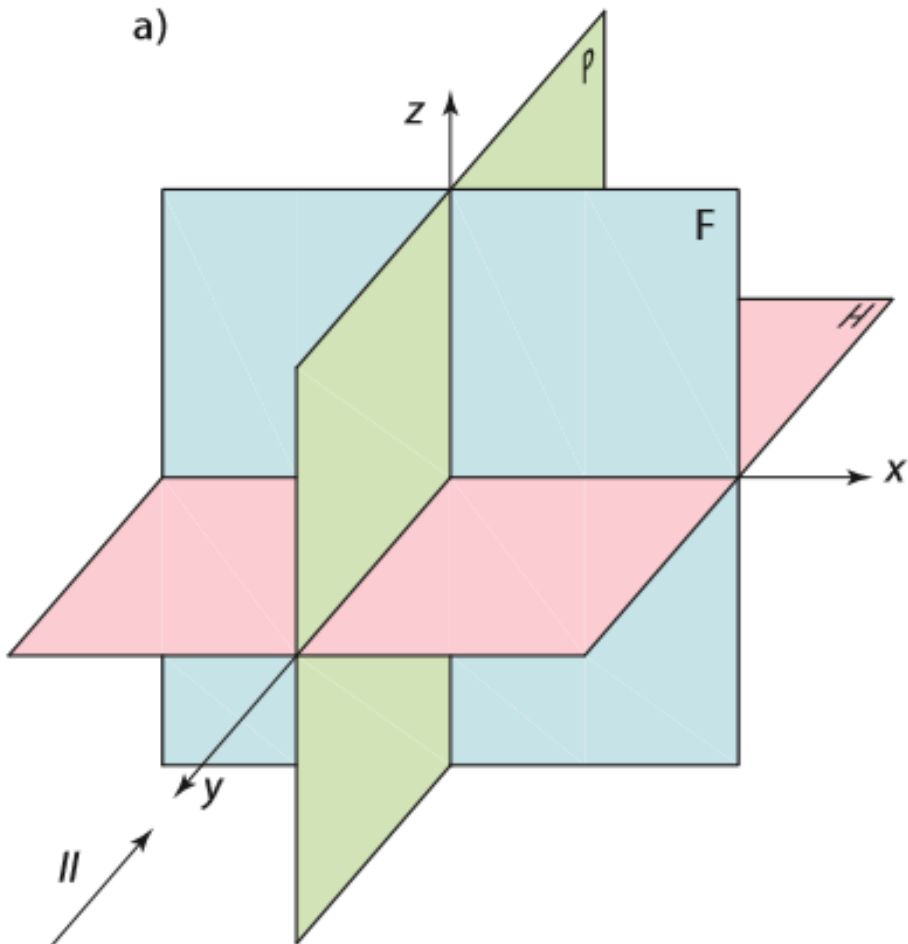

b)

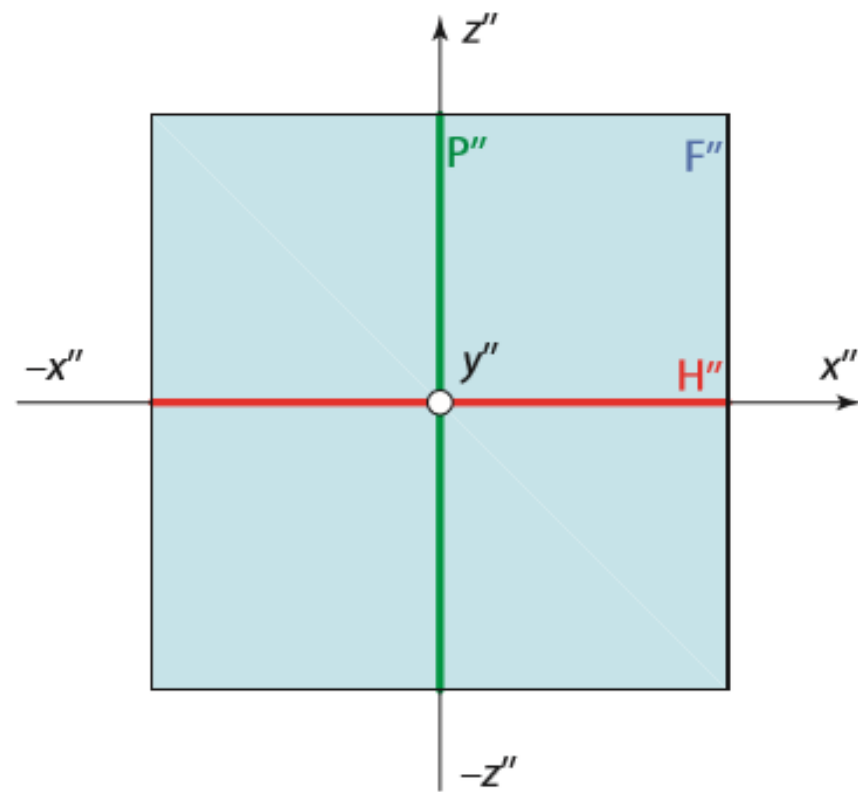

TREĆA PROJEKCIJA TRIEDRA

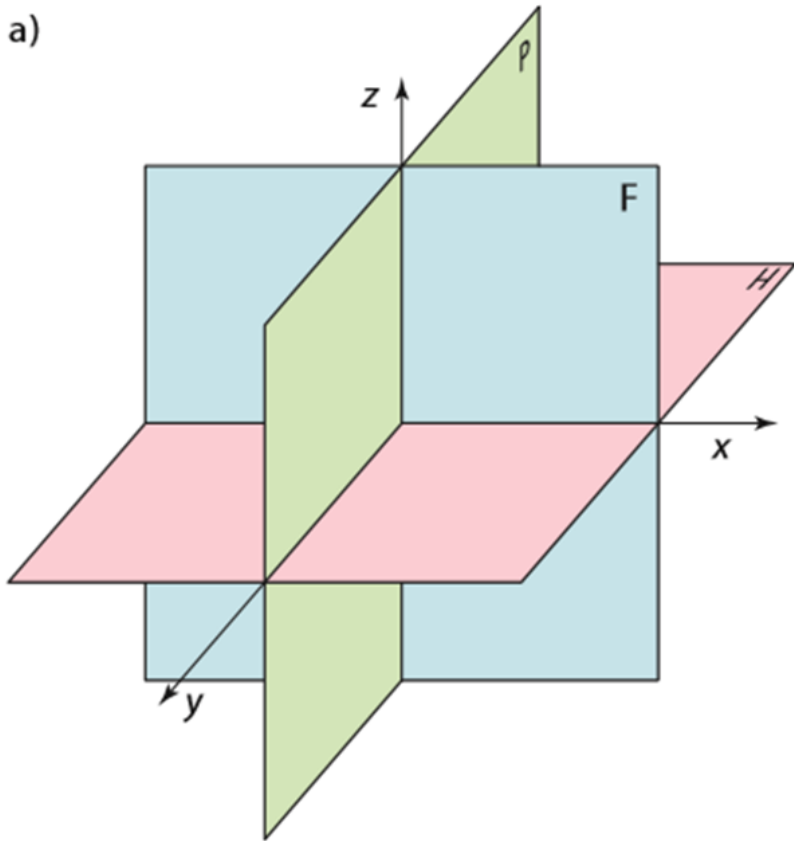

III ←

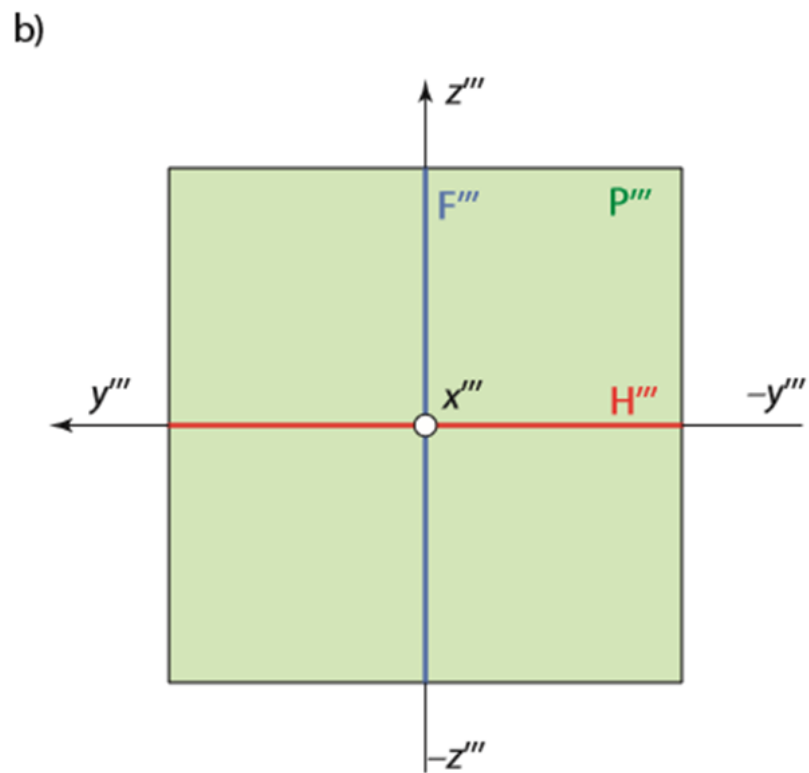

TRIEDAR U TRI ORTOGONALNE PROJEKCIJE

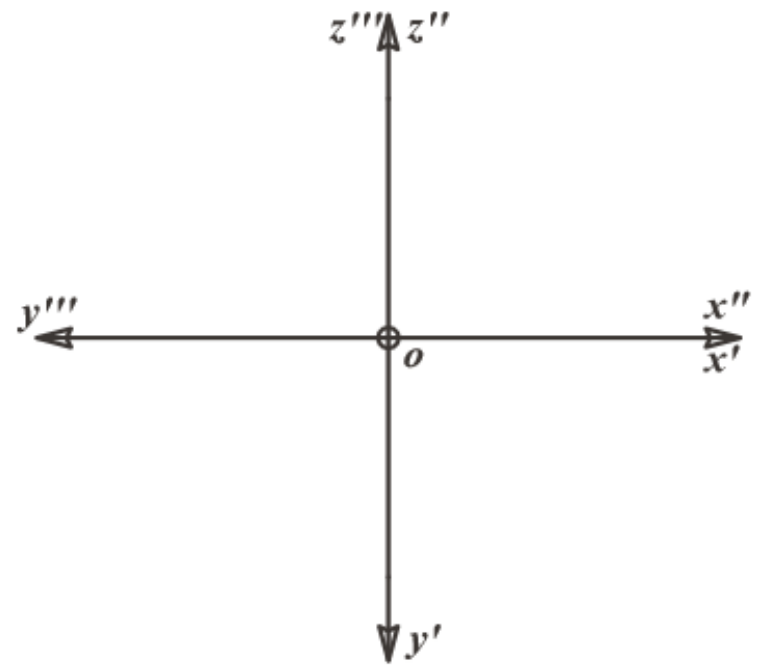
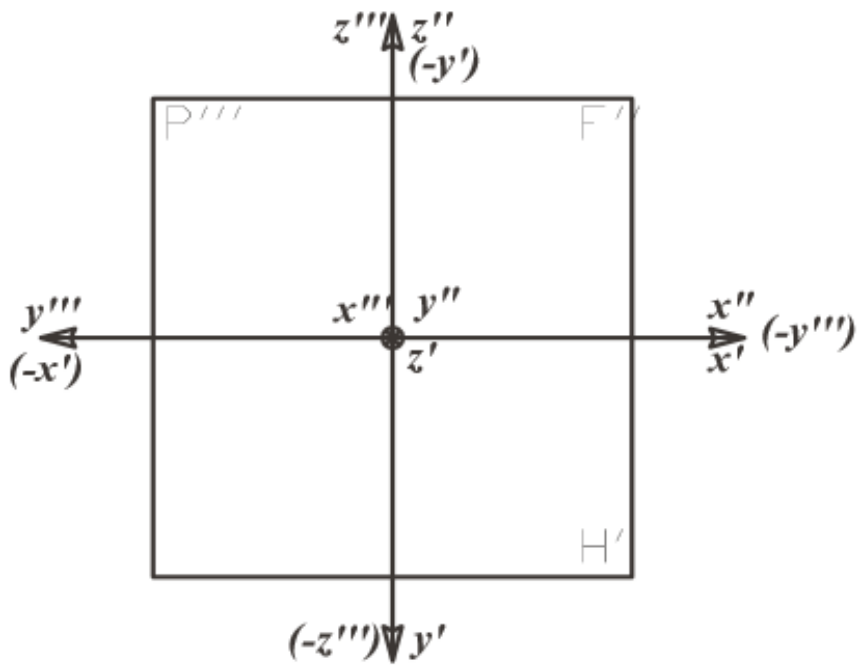

Koordinate tačke

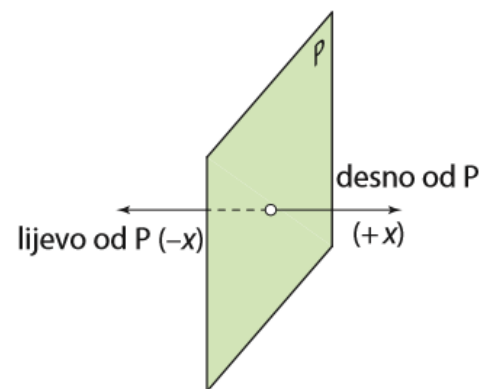
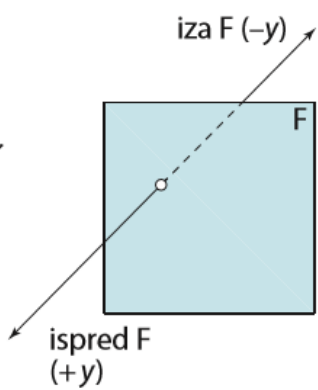
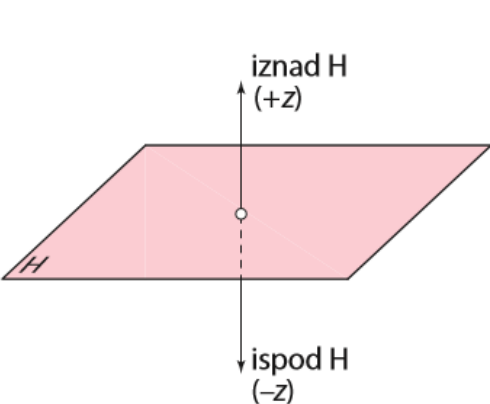
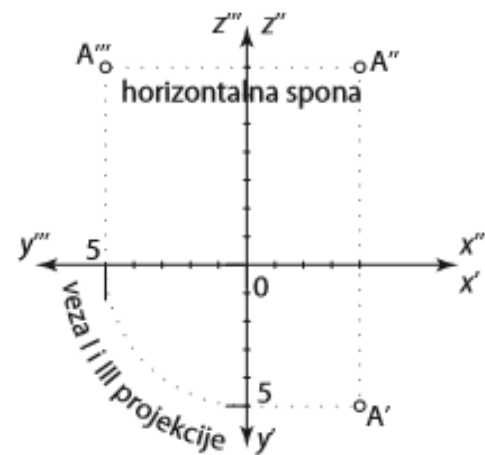
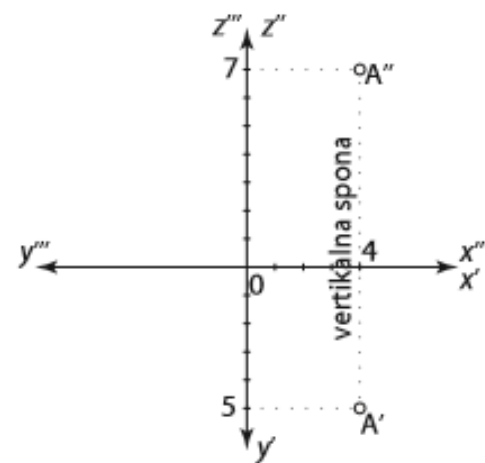
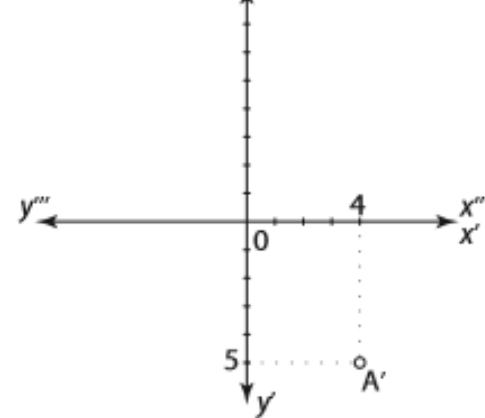
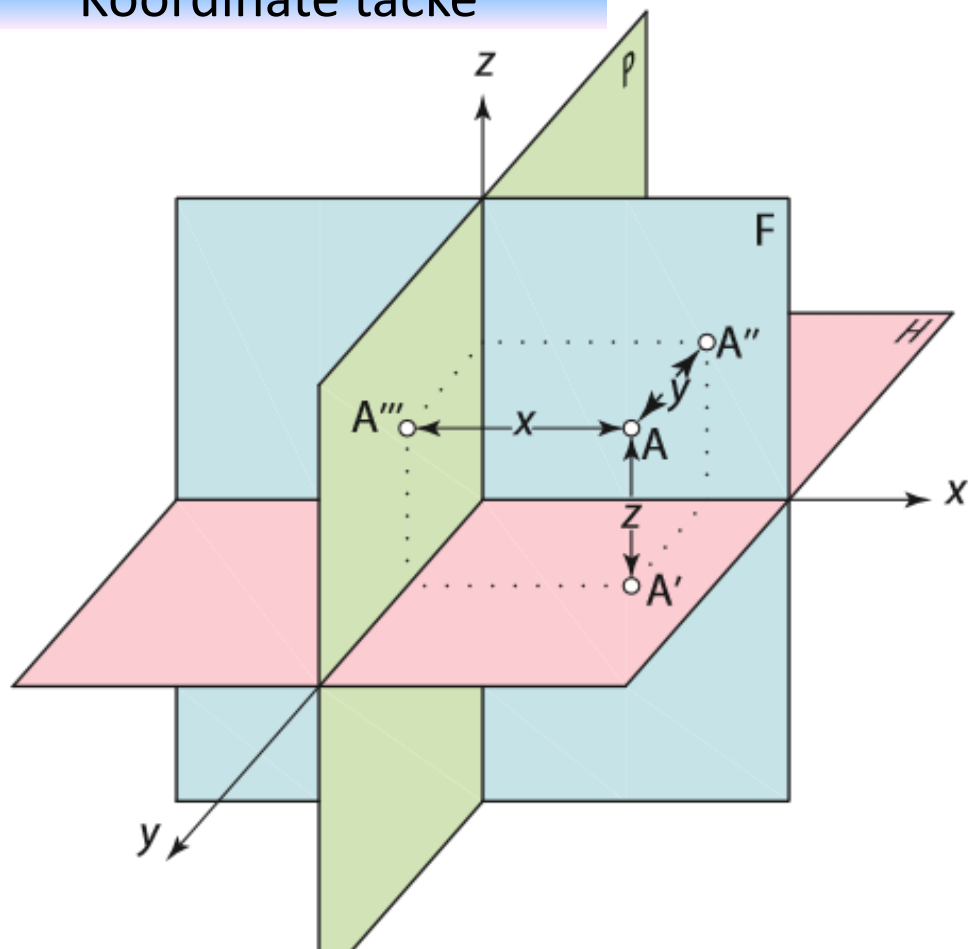

Kvadranti i oktanti

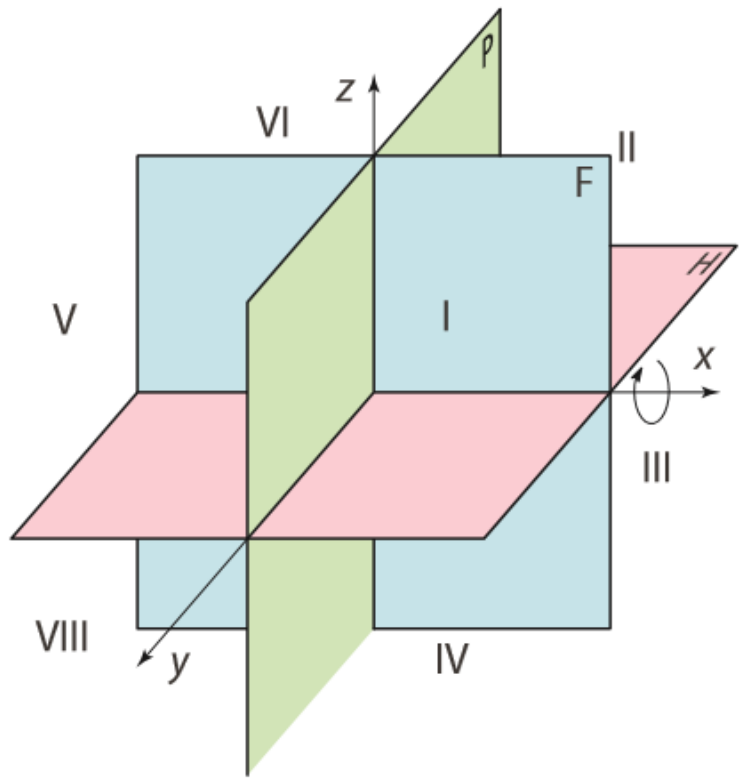
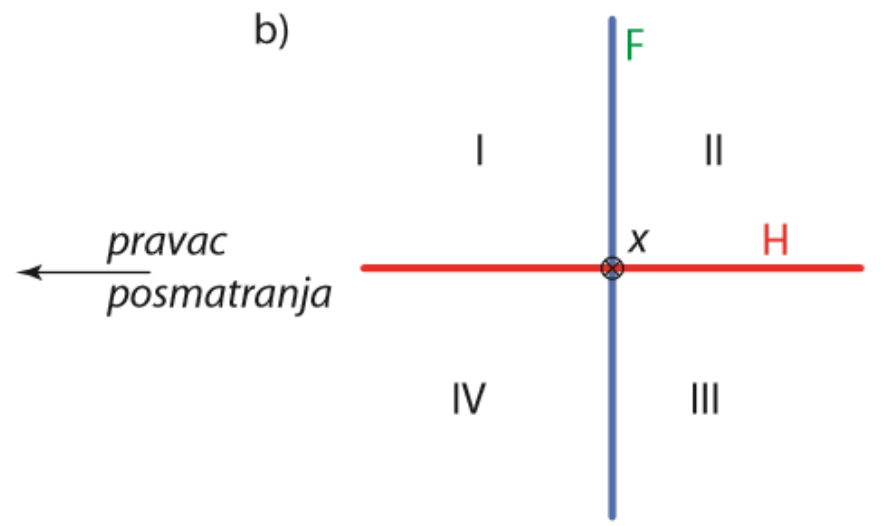
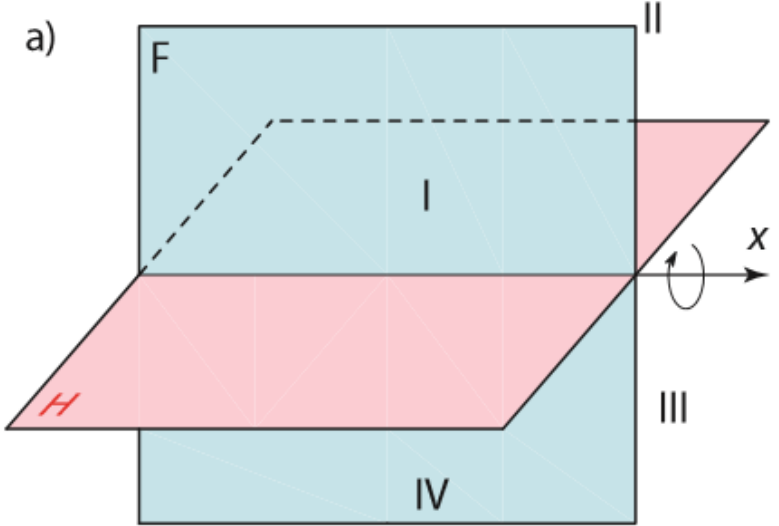

Prava, duž

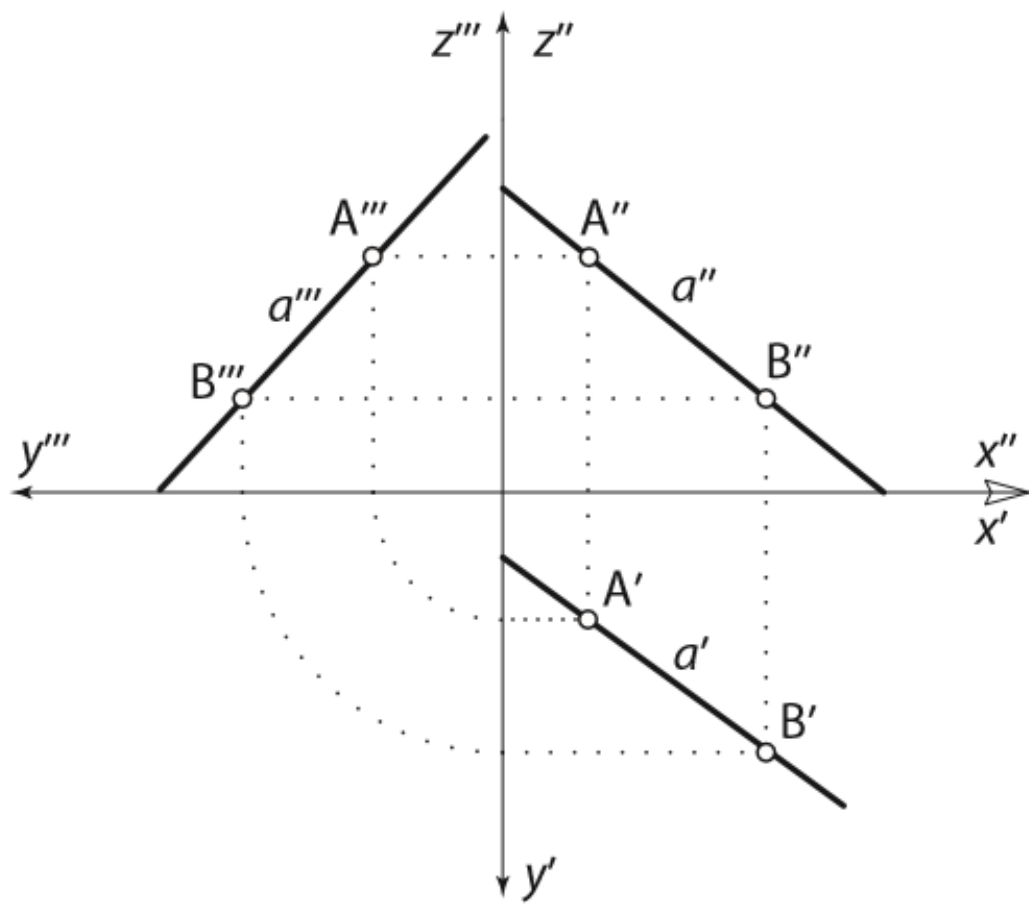
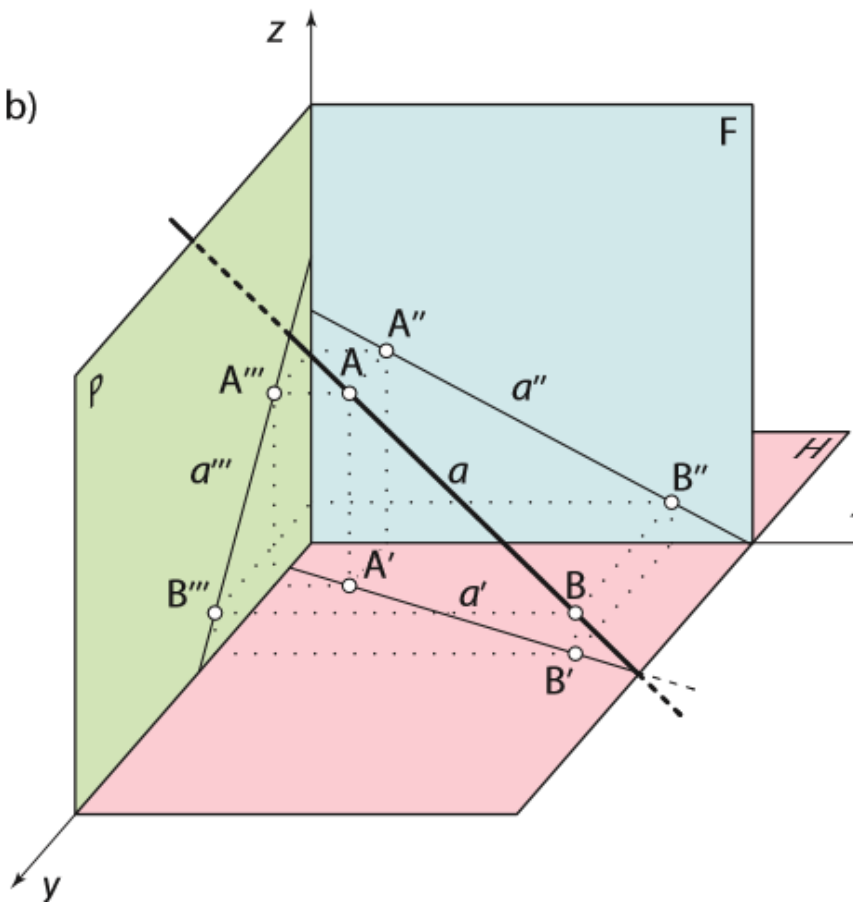

Prava, duž

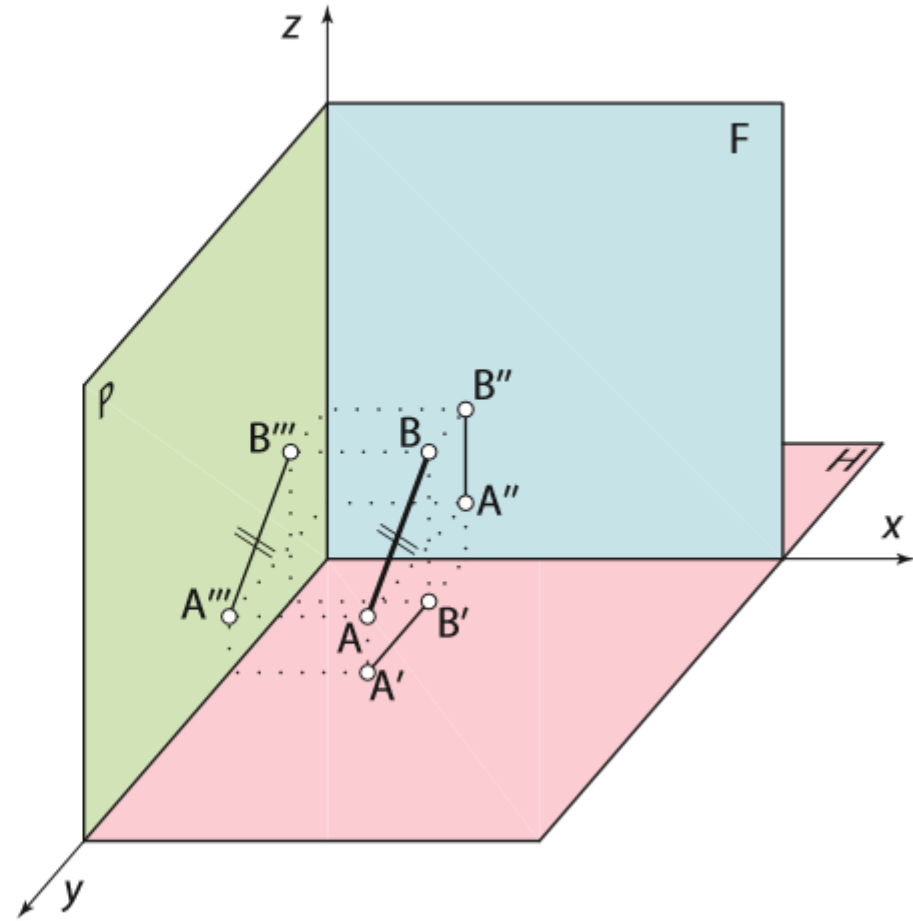
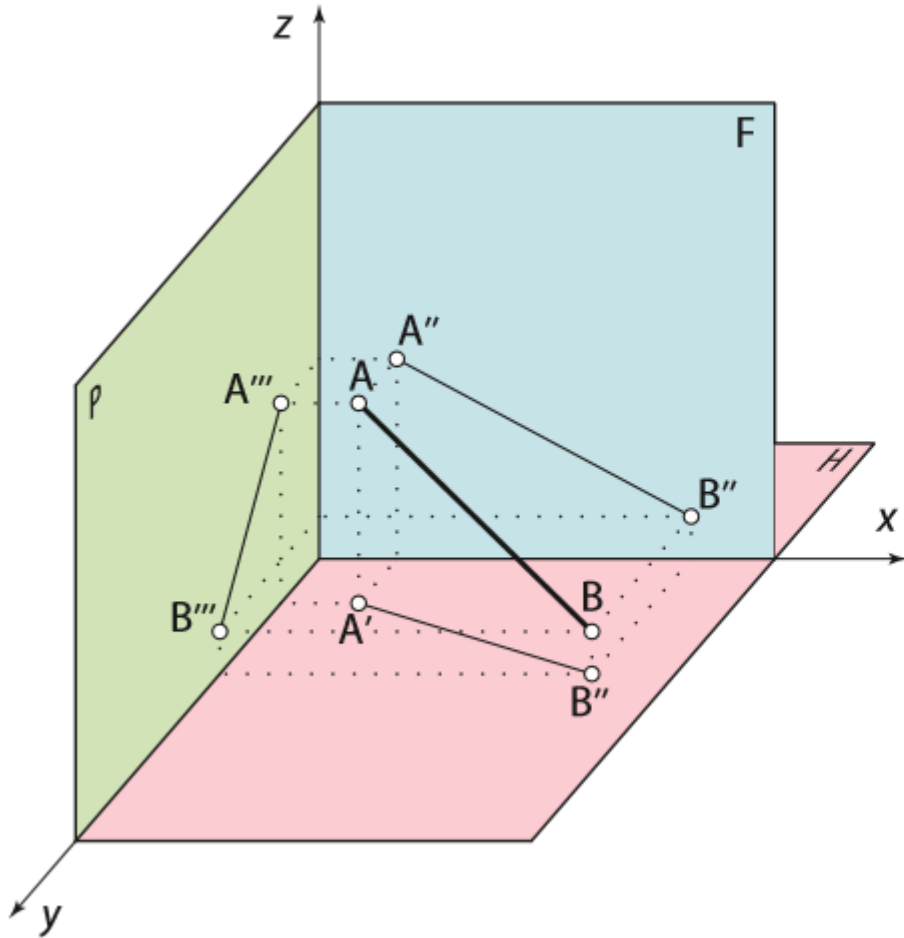

Prodori prave kroz projekcijske ravni

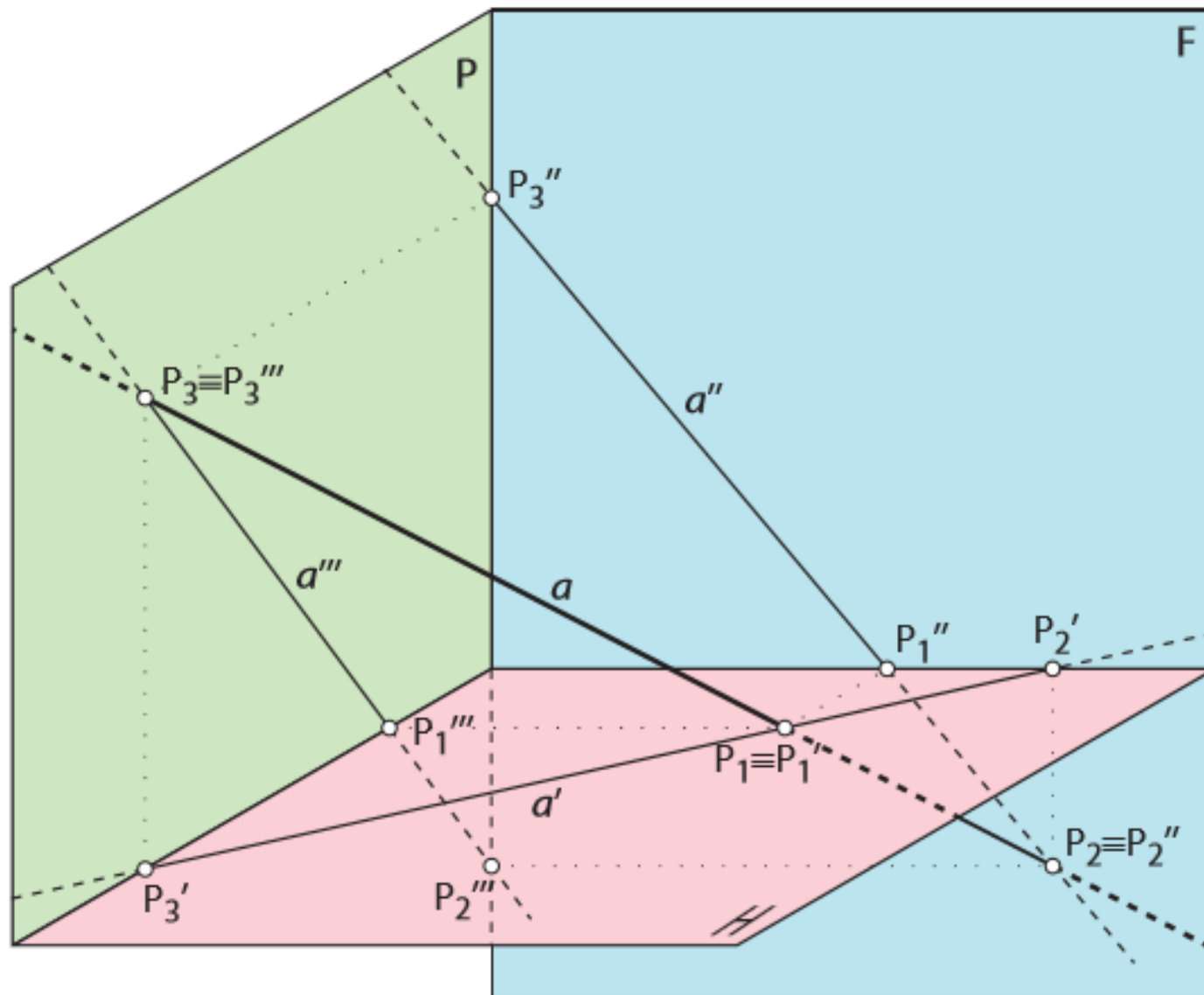

Prodori prave kroz projekcijske ravni

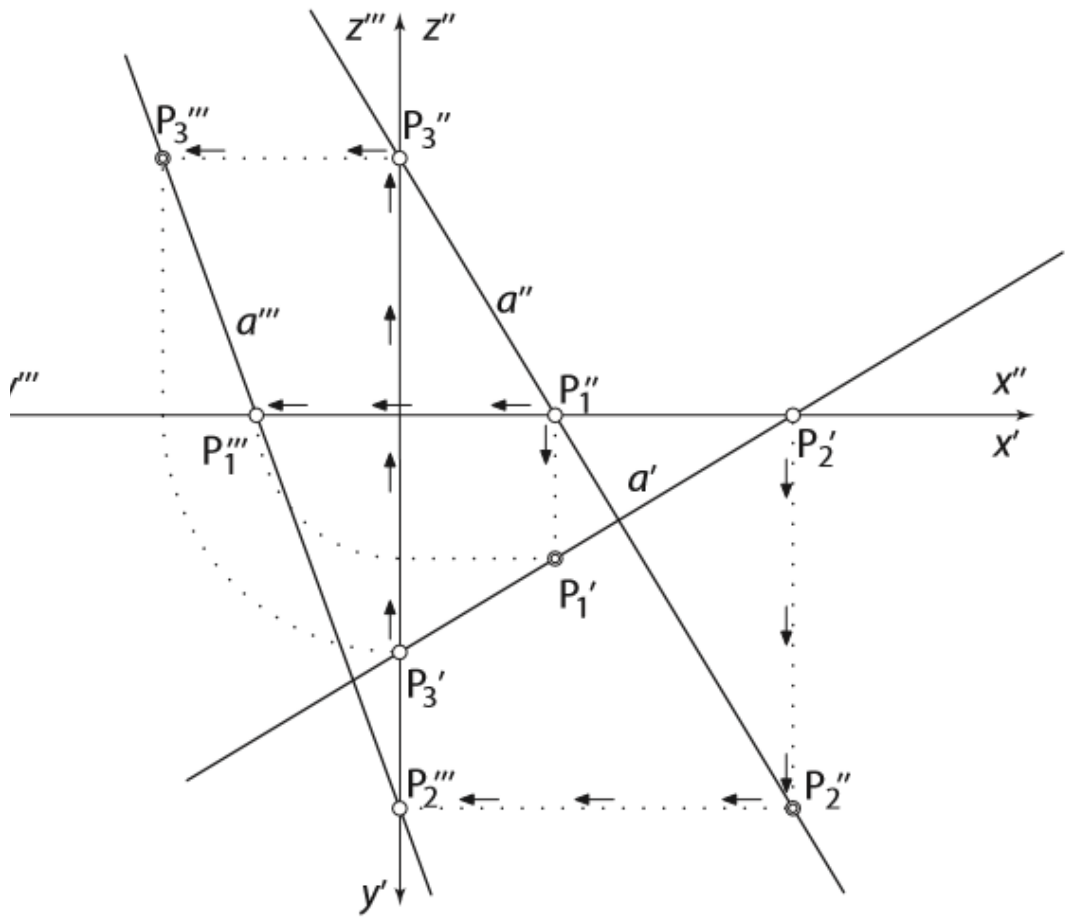
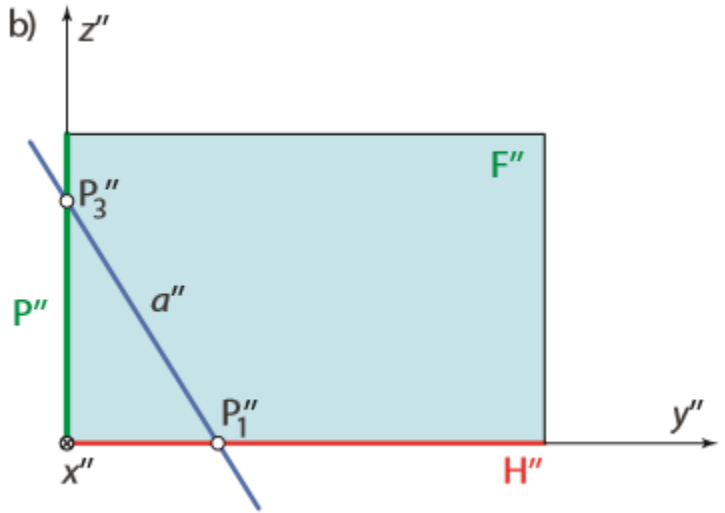
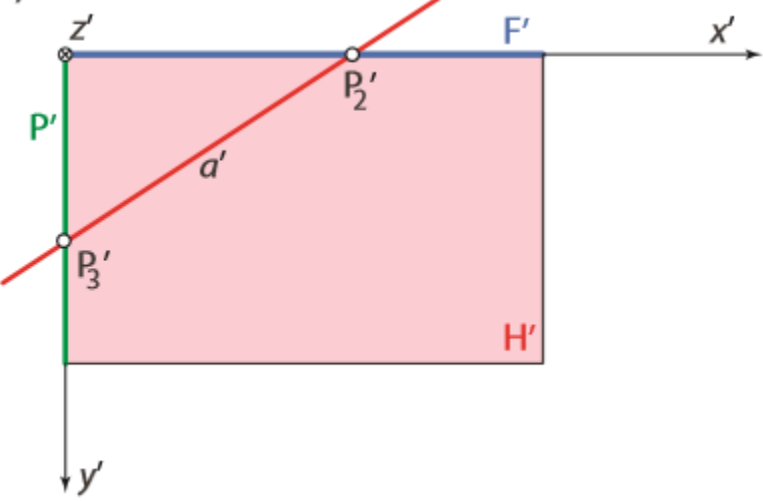

Vidljivost prave u projekcijama

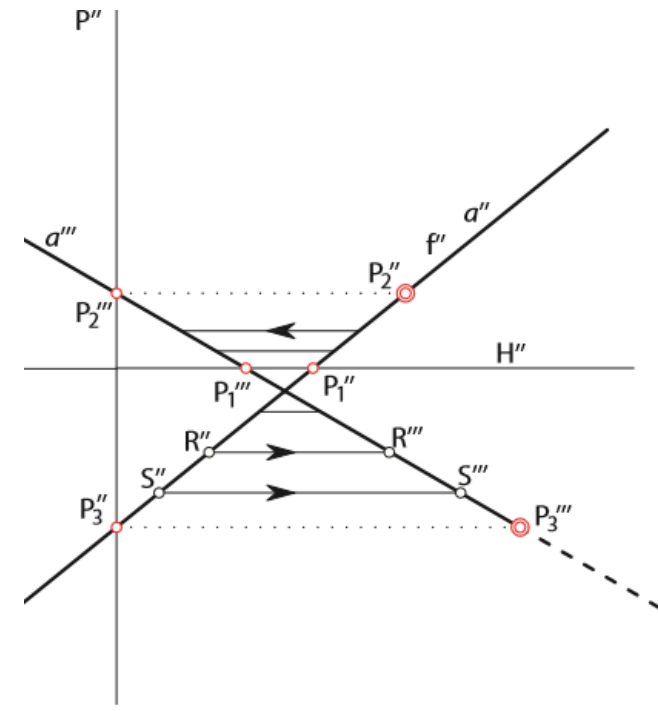
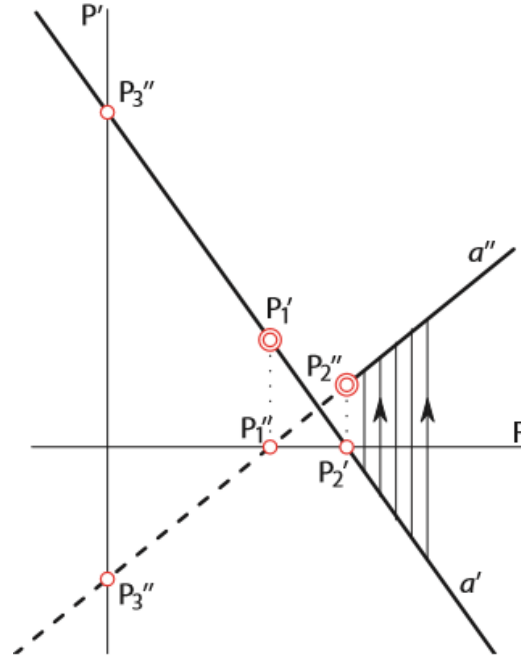
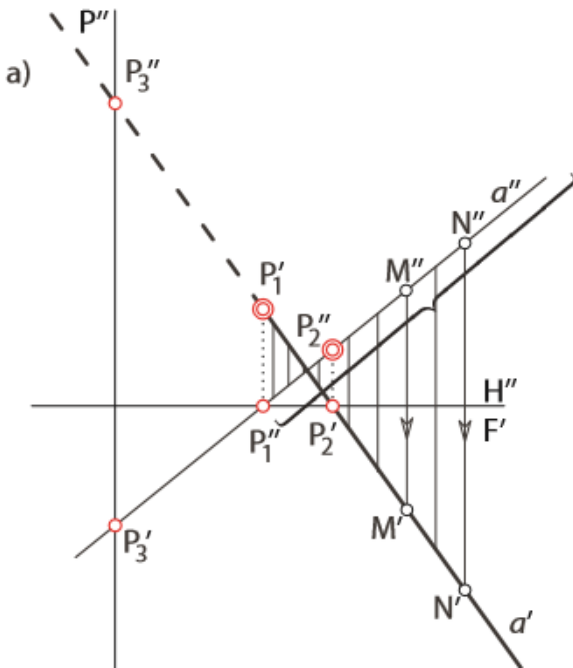
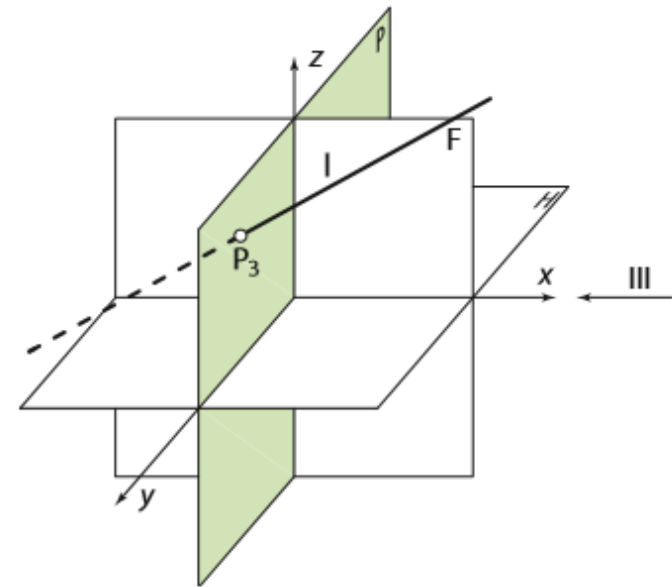
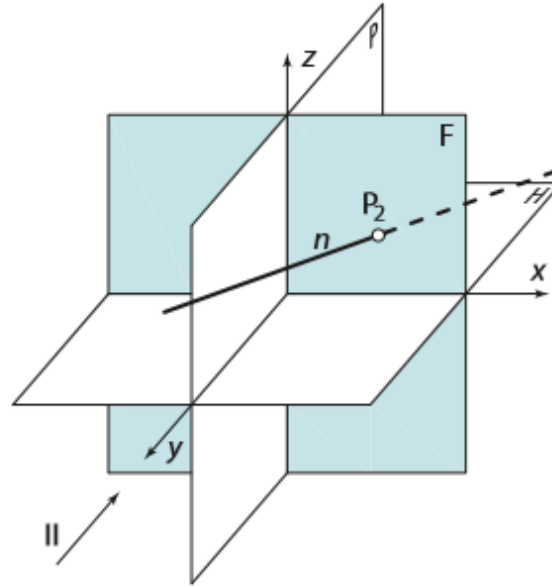
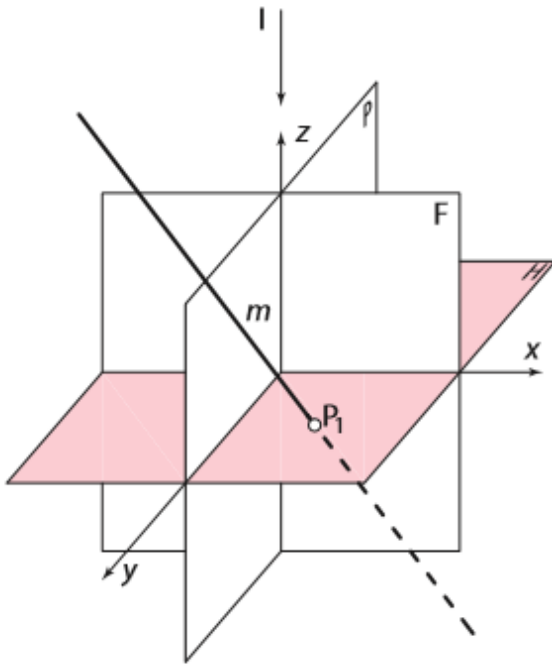

Oktanti kroz koje prava prolazi

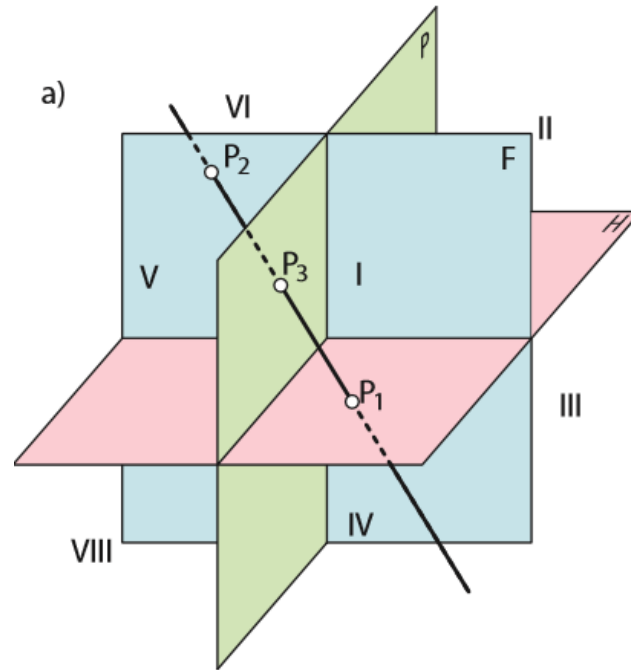
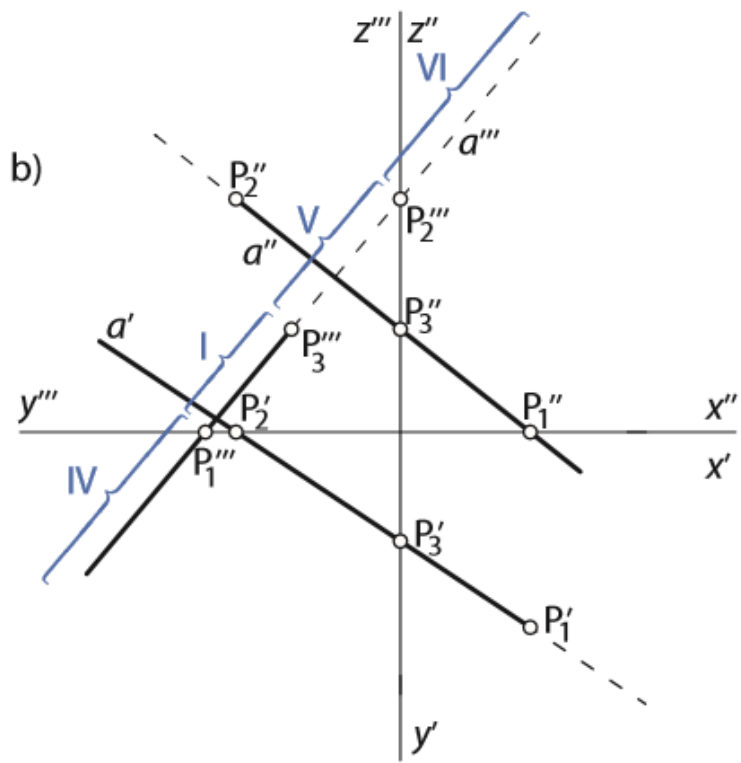

a) Prva projekcija triedra:

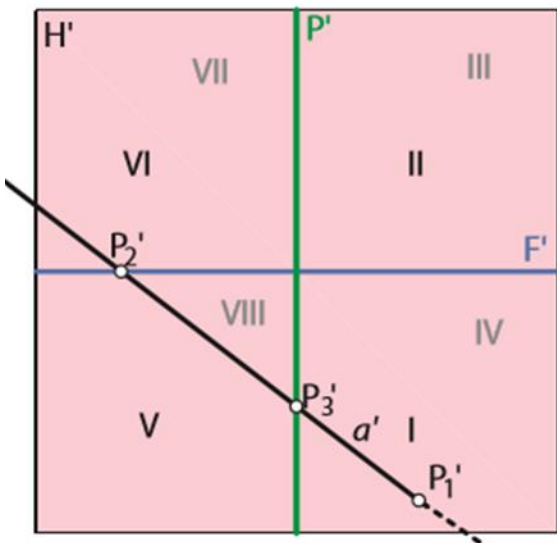

b) Druga projekcija triedra:

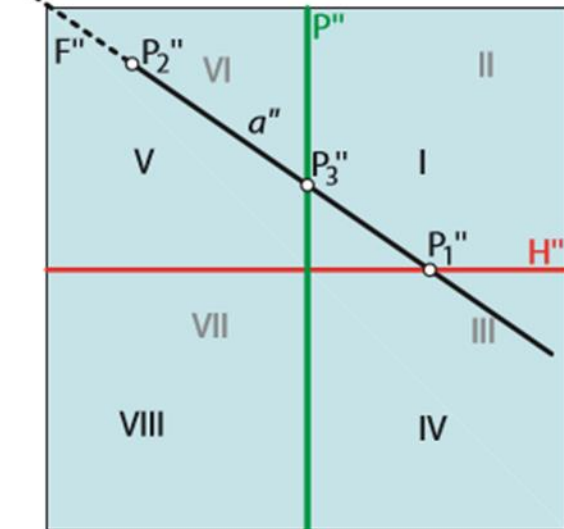

c) Treća projekcija triedra:

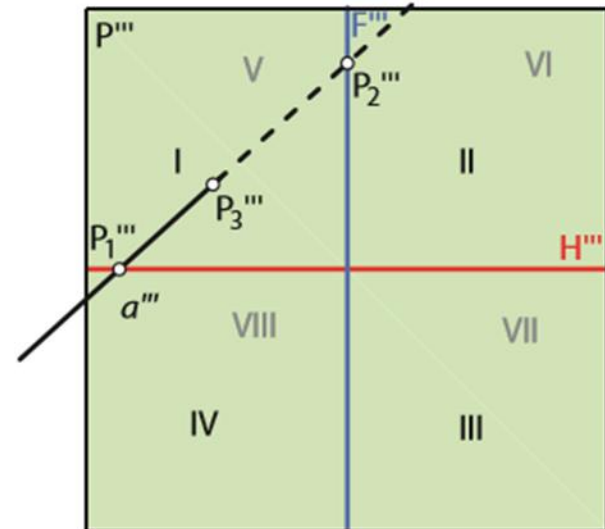

Međusobni položaj dvije prave

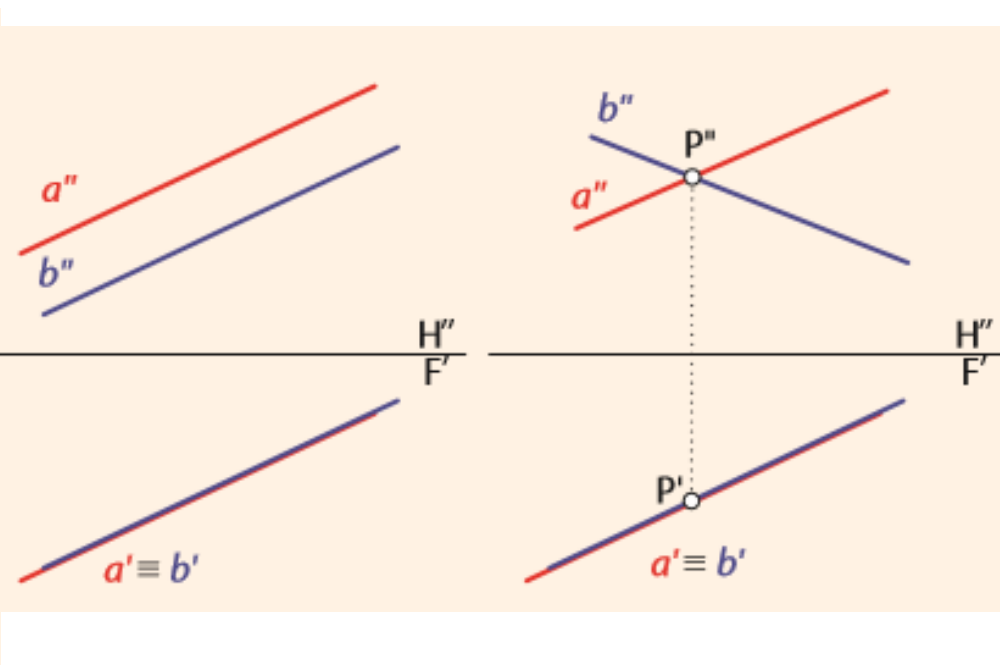
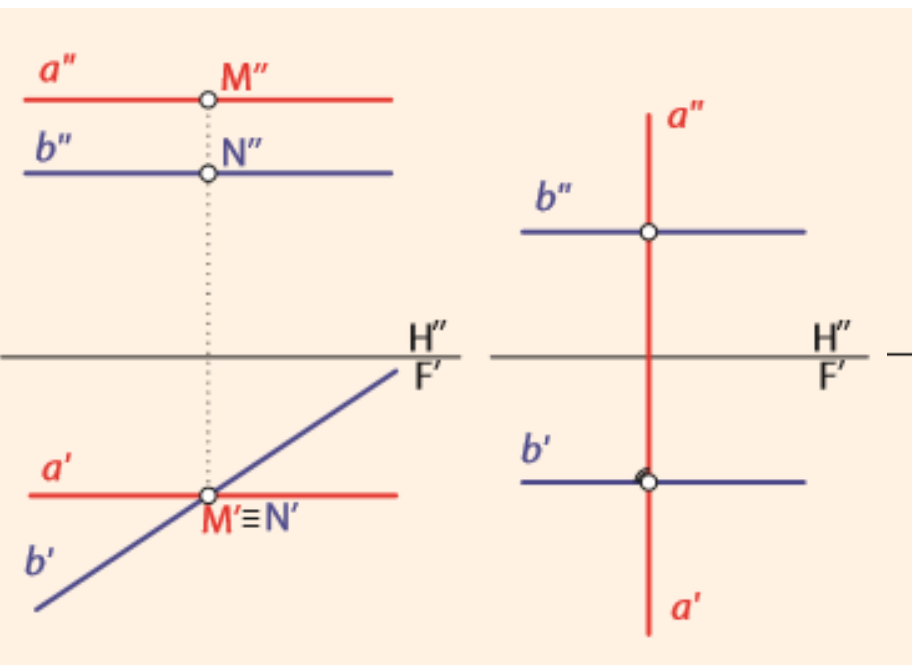
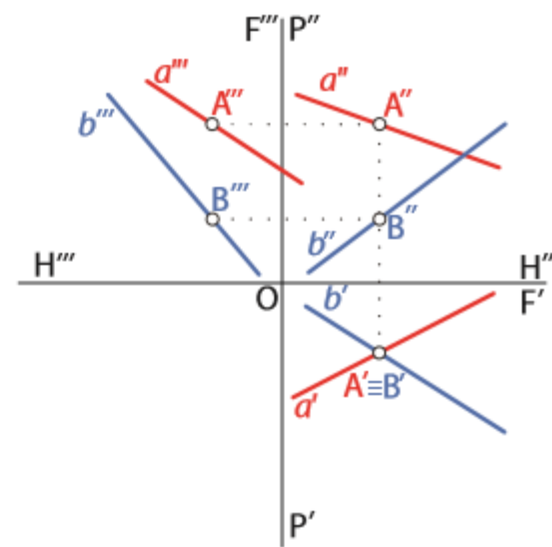
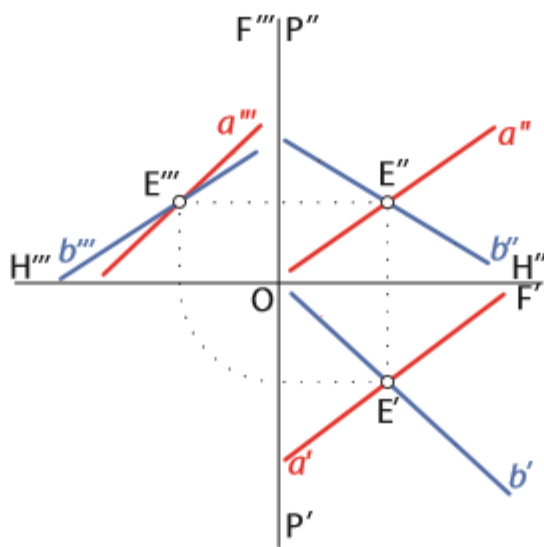
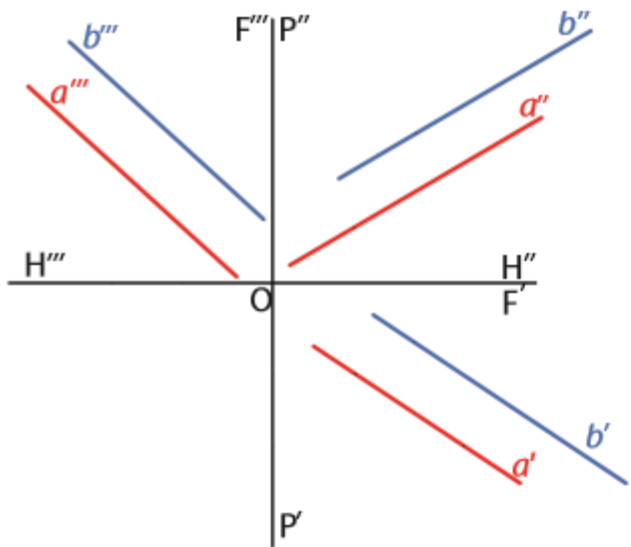

Prave u specijalnom položaju

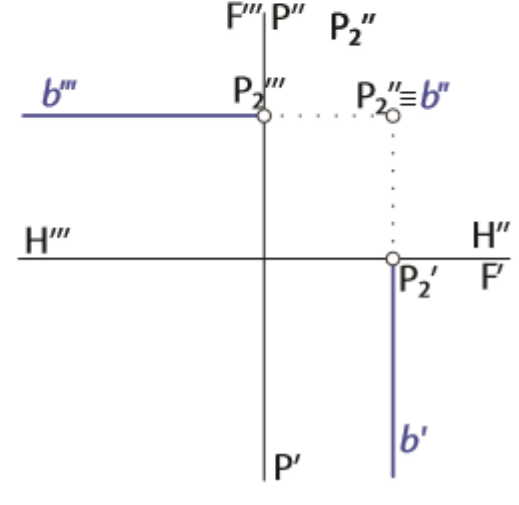
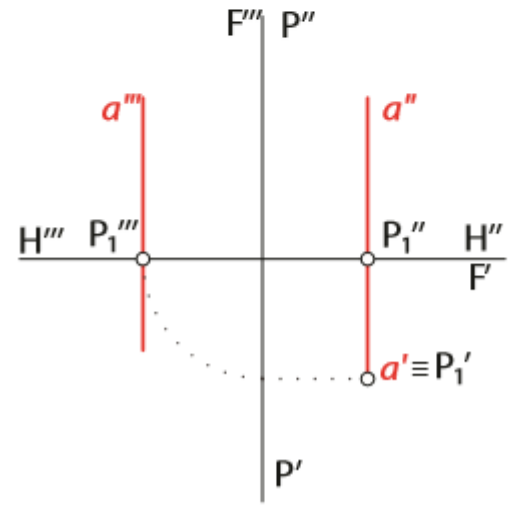
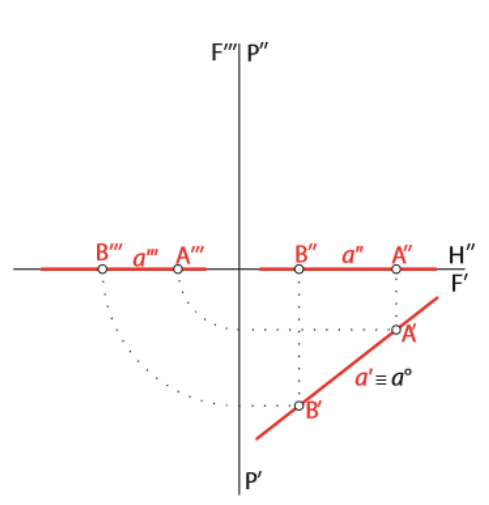
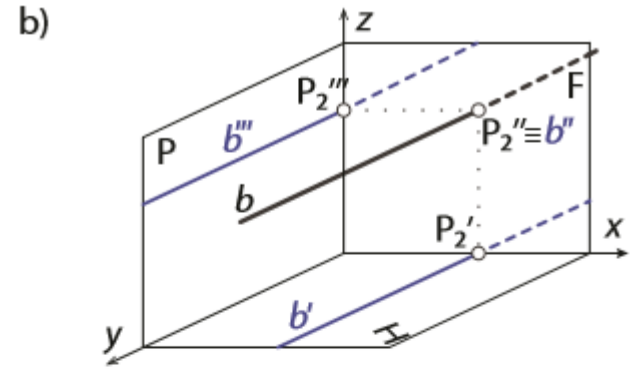
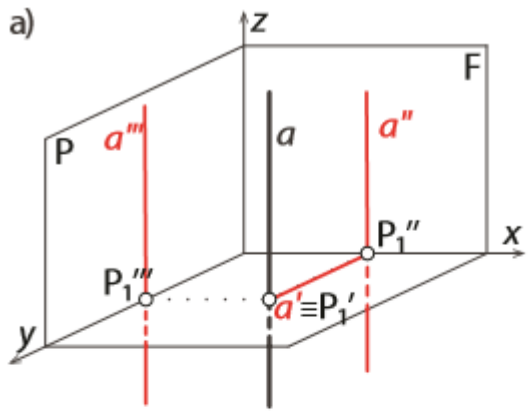
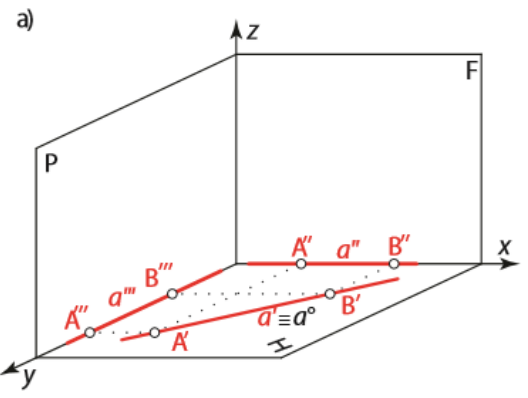

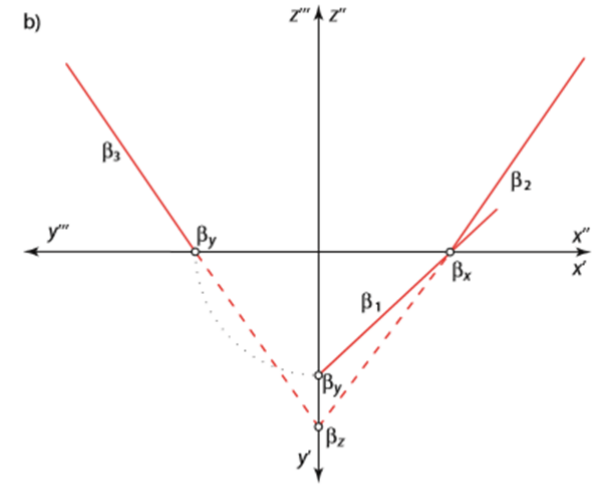
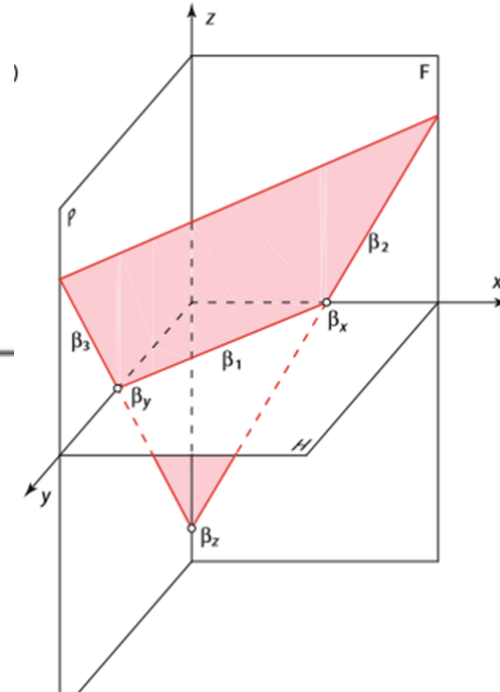
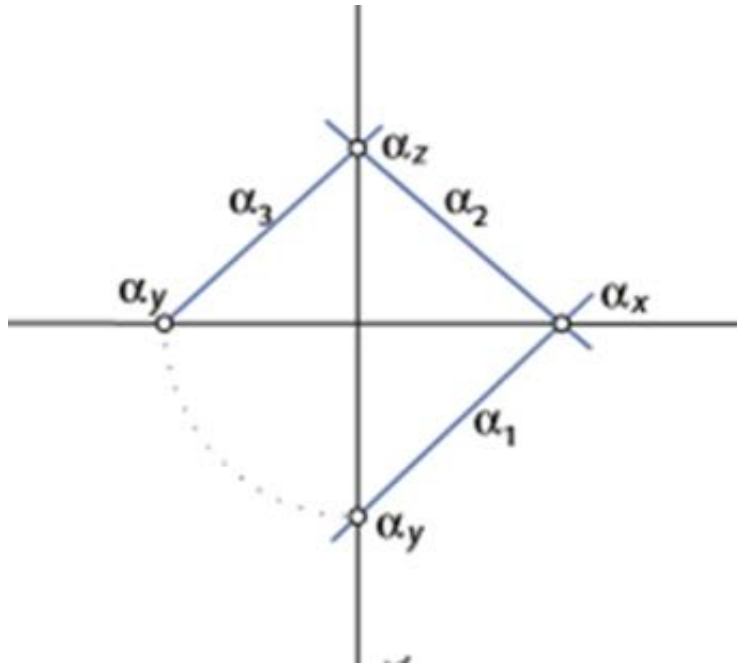
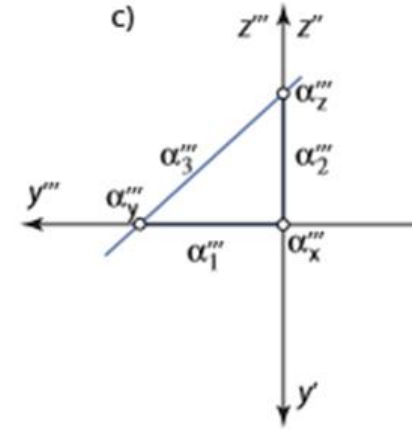
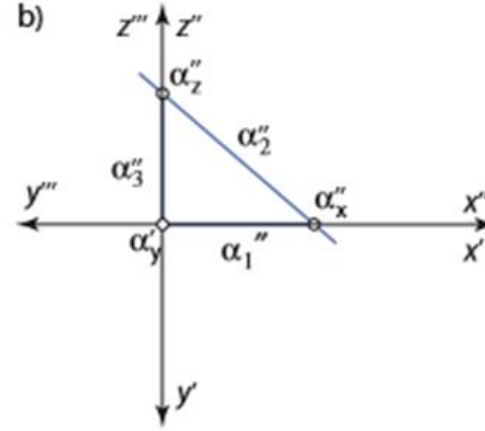
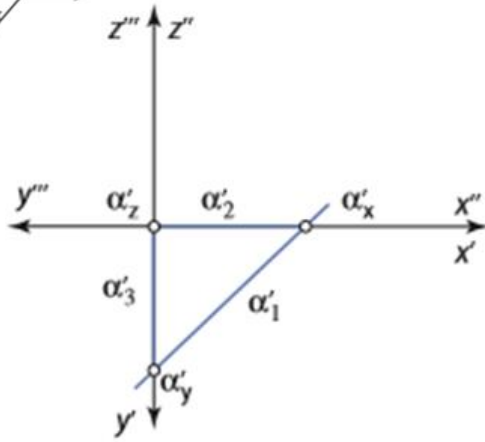
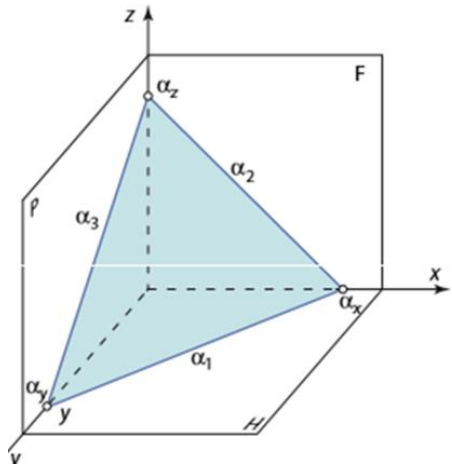

Ravni u specijalnom položaju

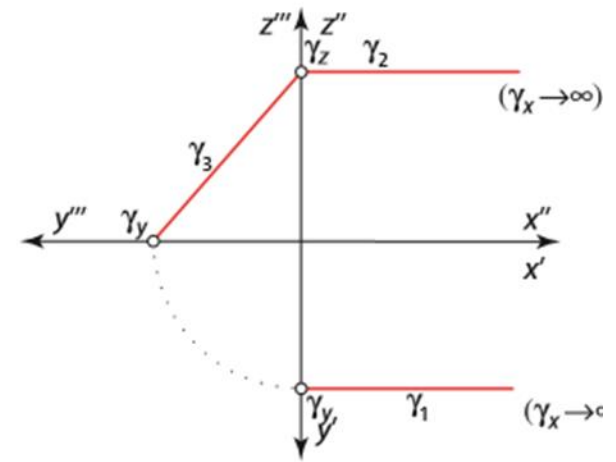
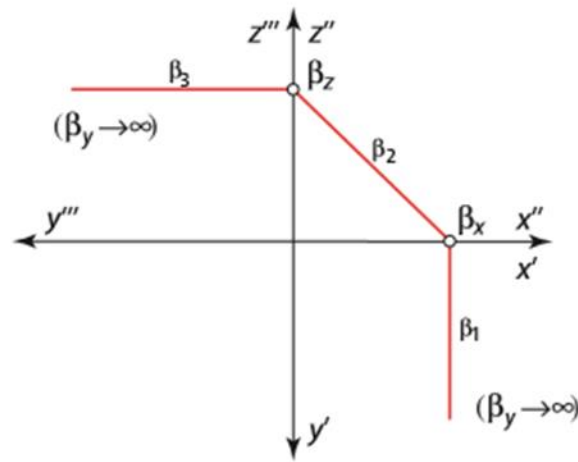
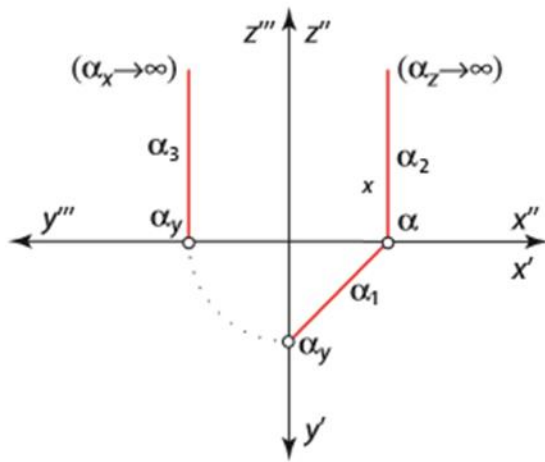
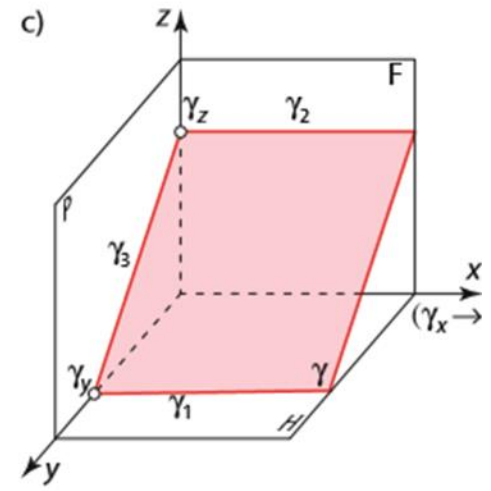
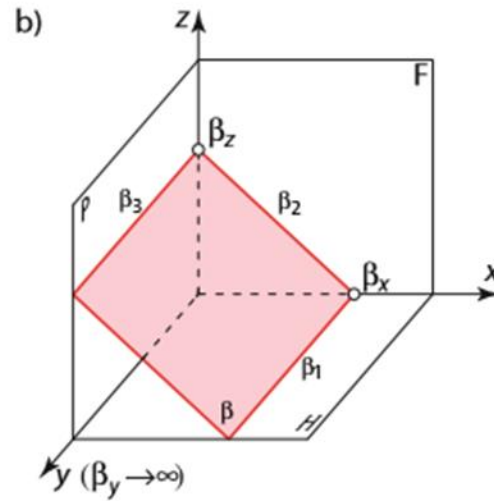
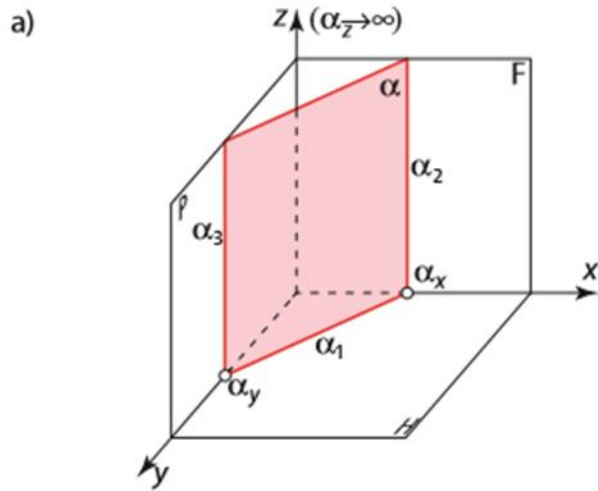

Pripadnost prave i tačke ravni

$$m \in T \Leftrightarrow P_1 \in t_1 \wedge P_2 \in t_2 \wedge P_3 \in t_3$$

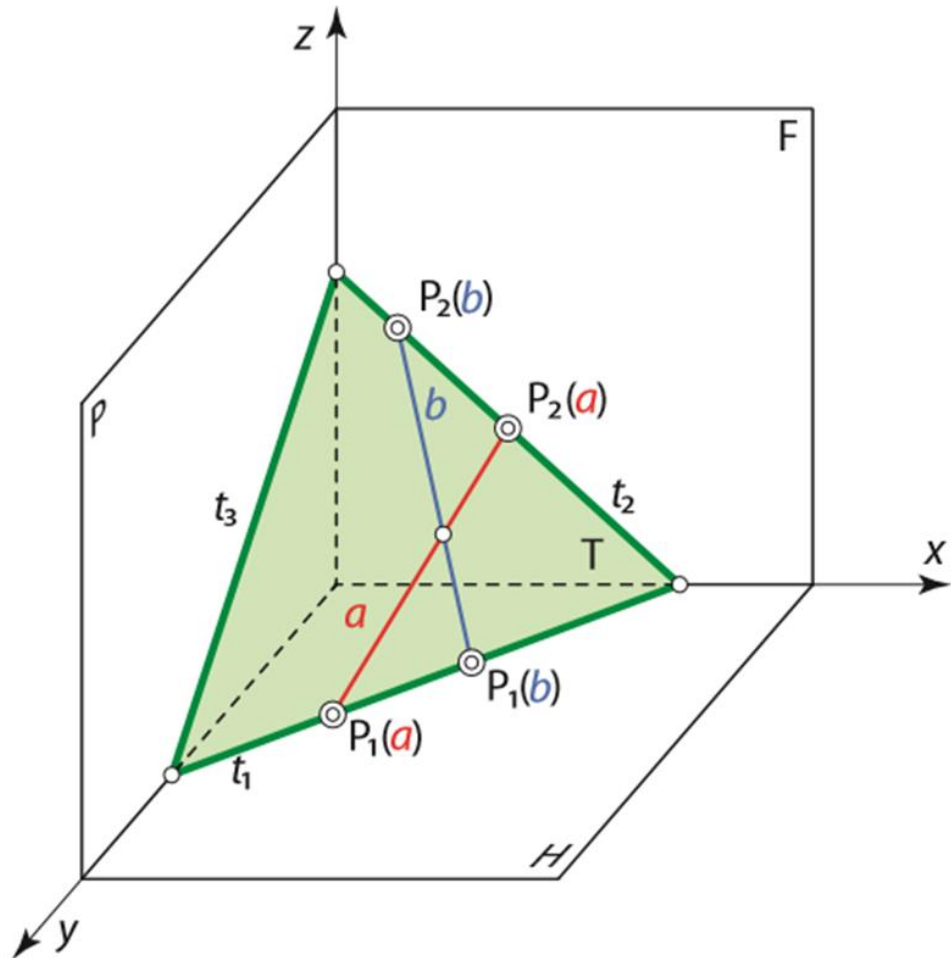
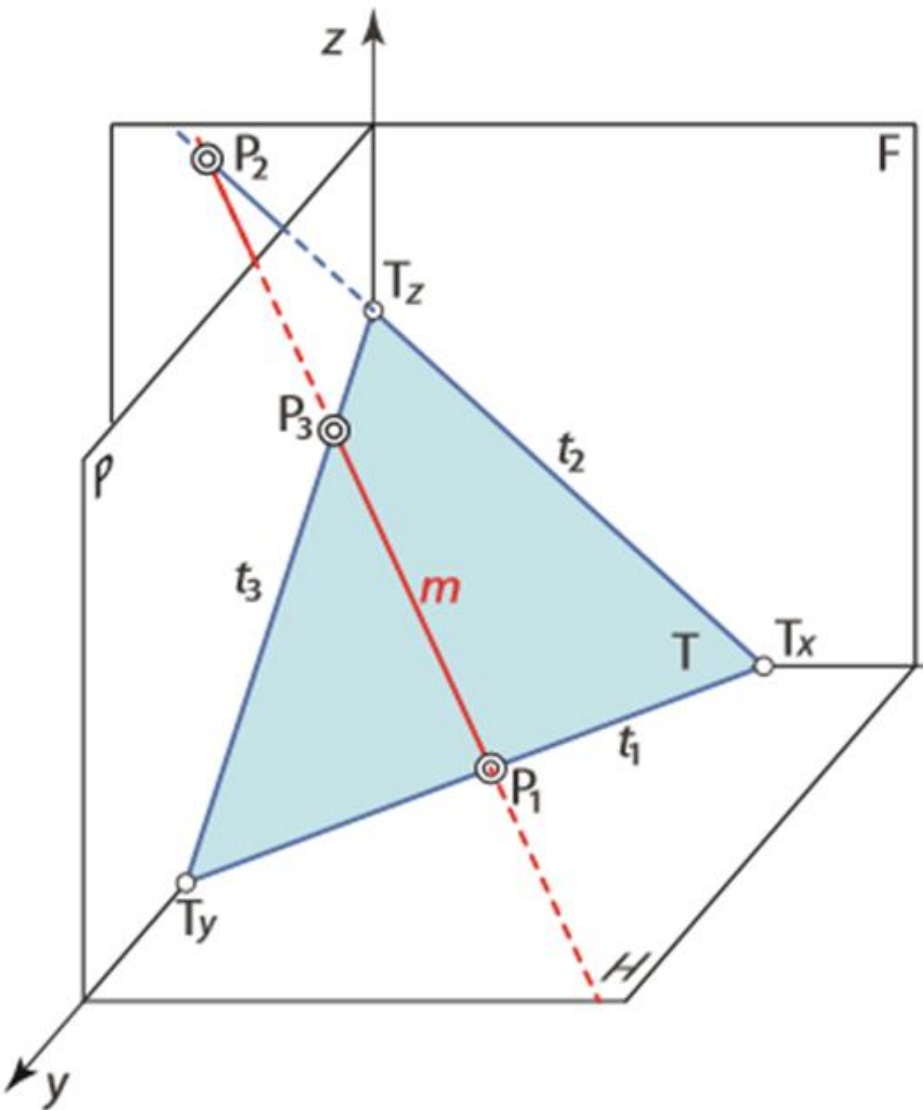

Presjek dvije ravni

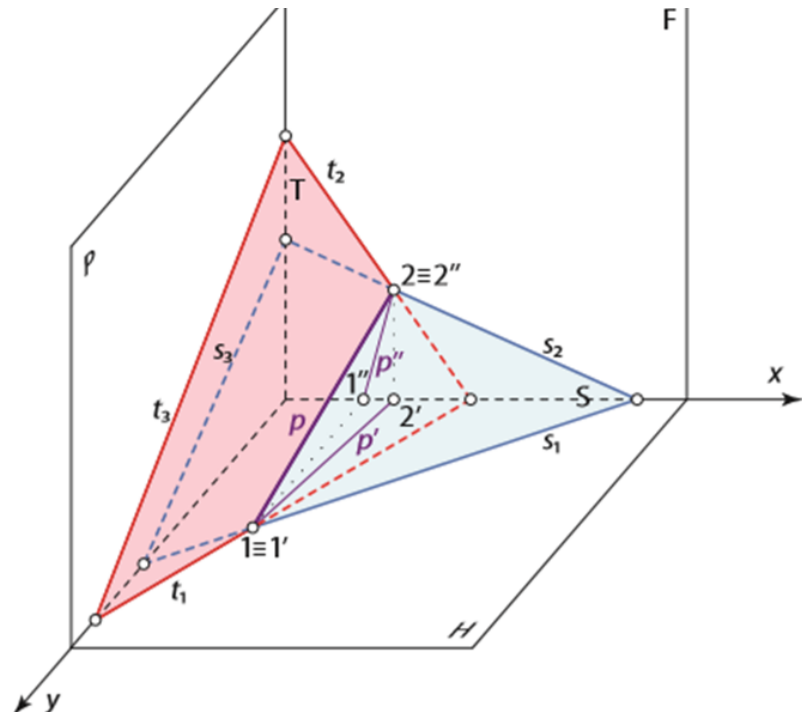
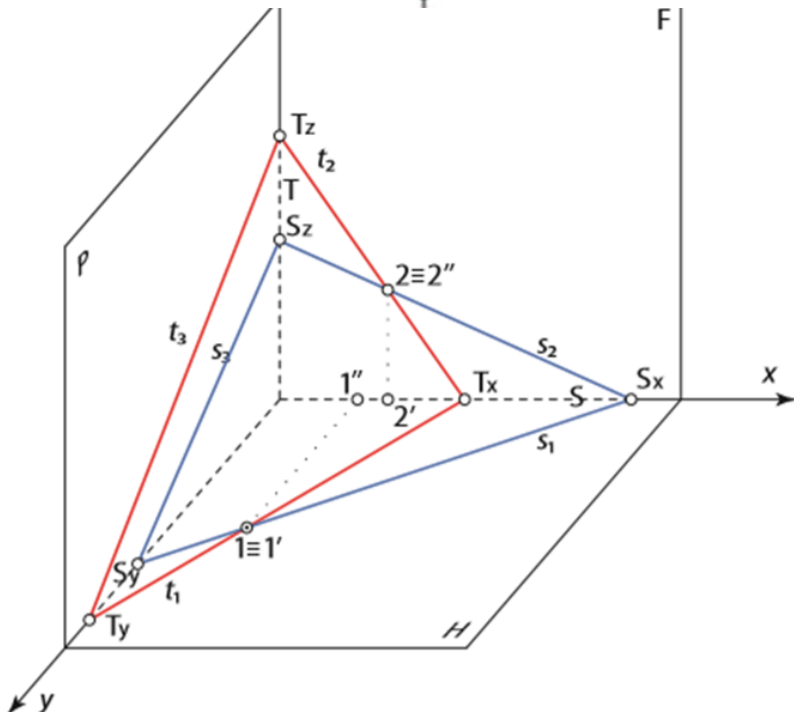
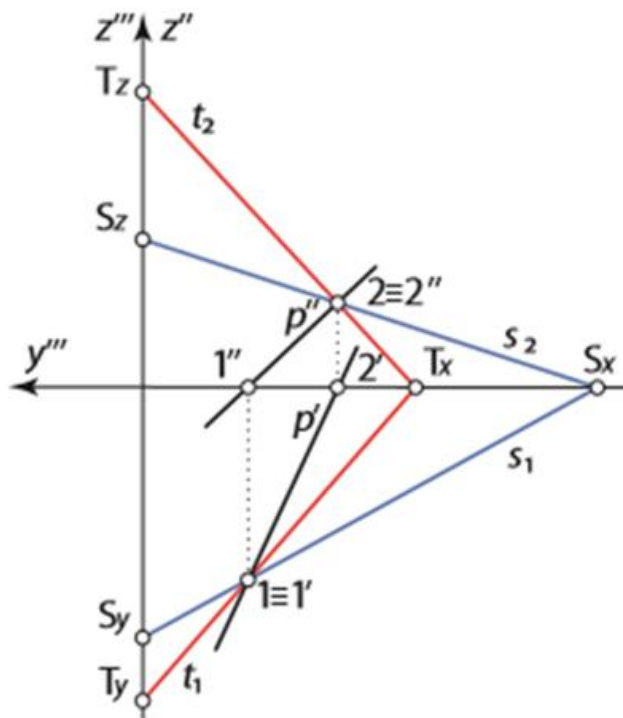

Prodor prave kroz ravan

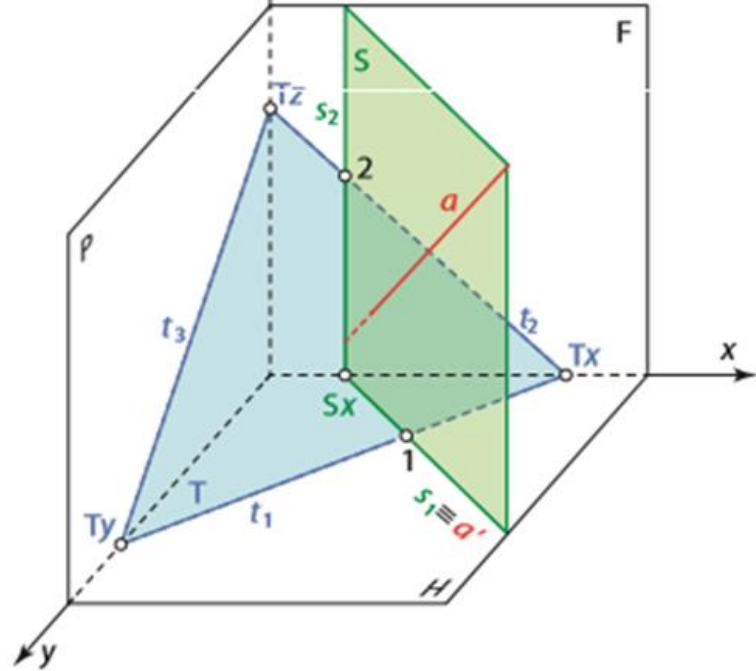
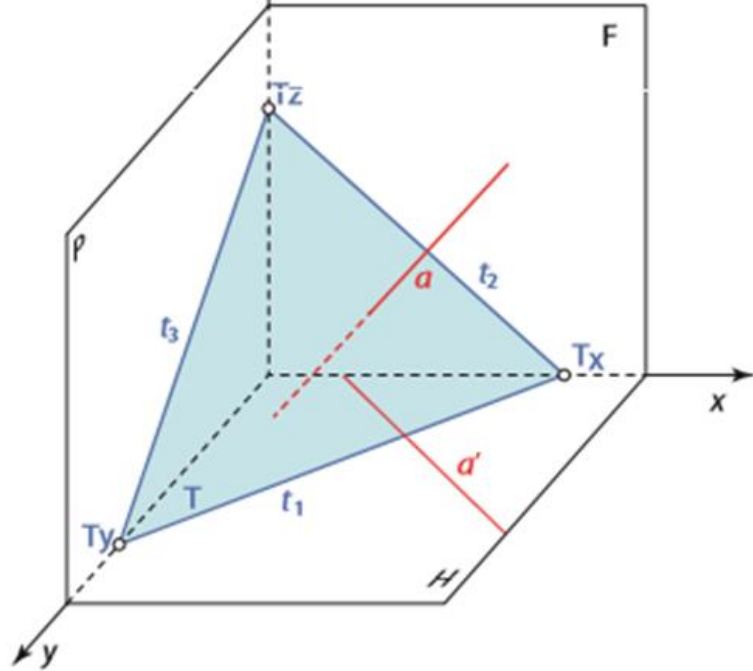

c)

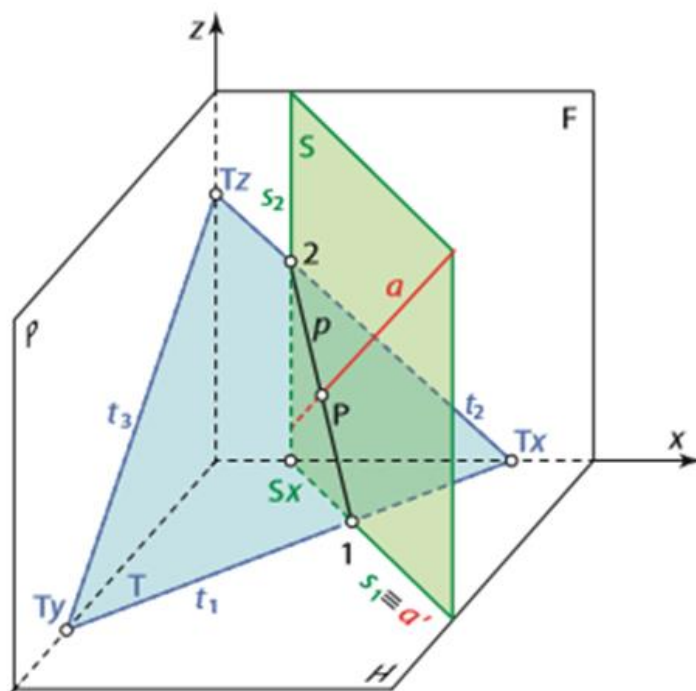

Prodor prave kroz ravan

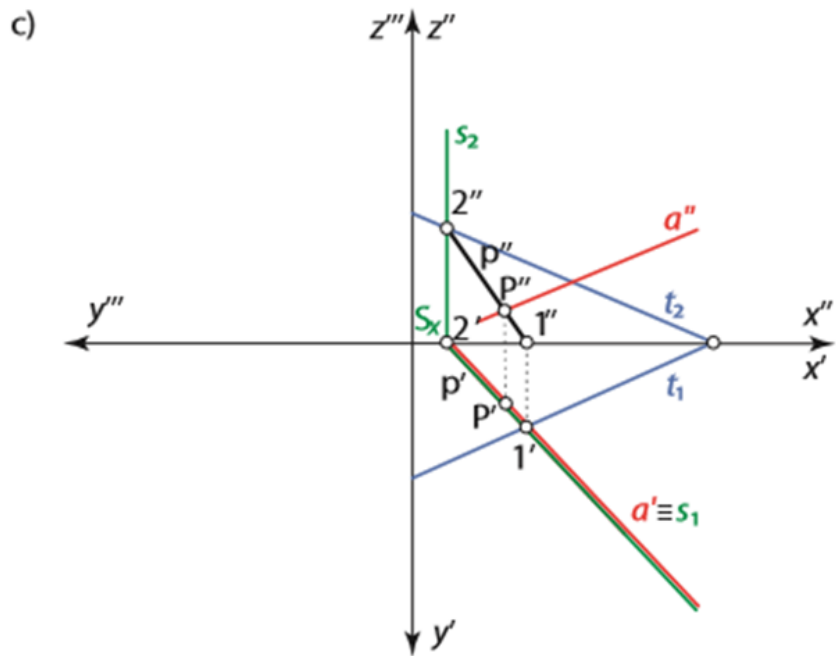
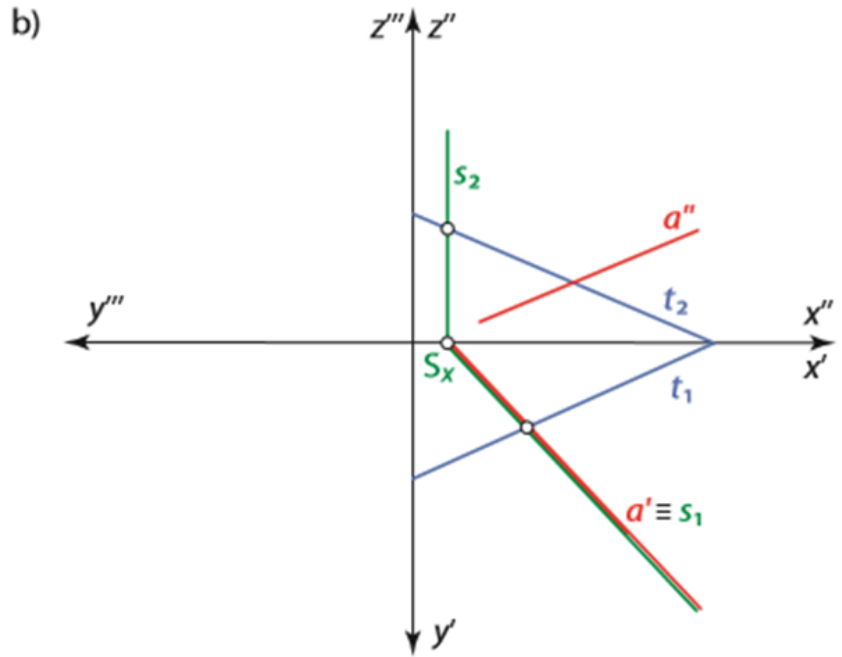
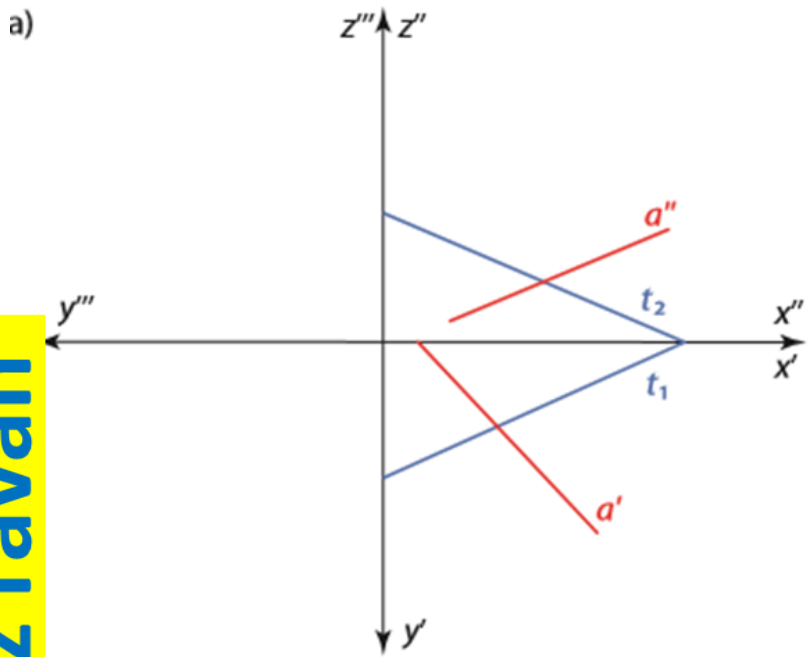

Specijalne prave u ravni – horizontala (h)

a)

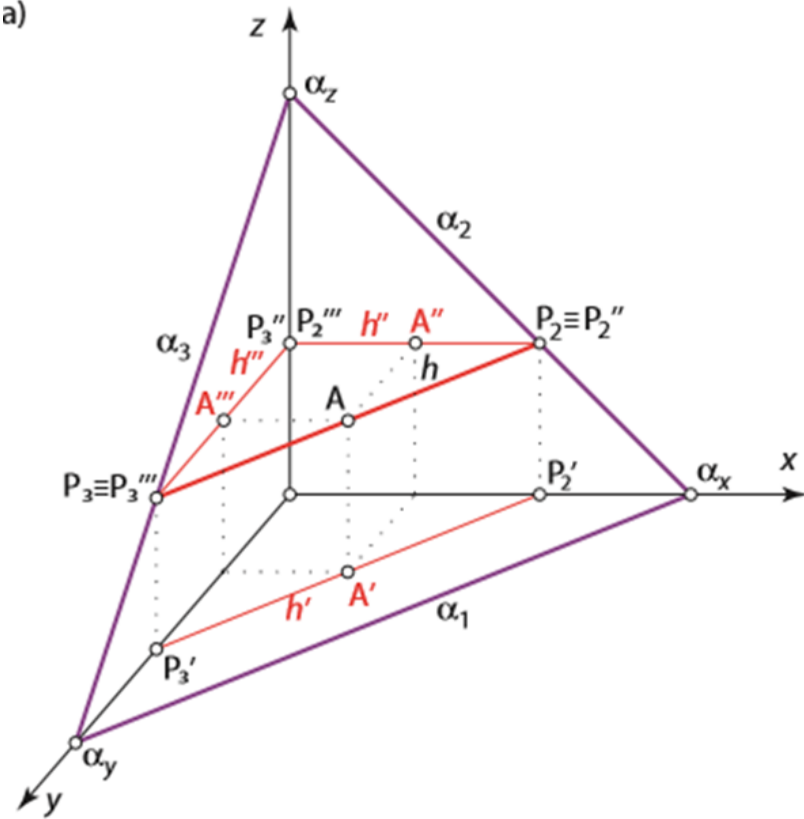

b)

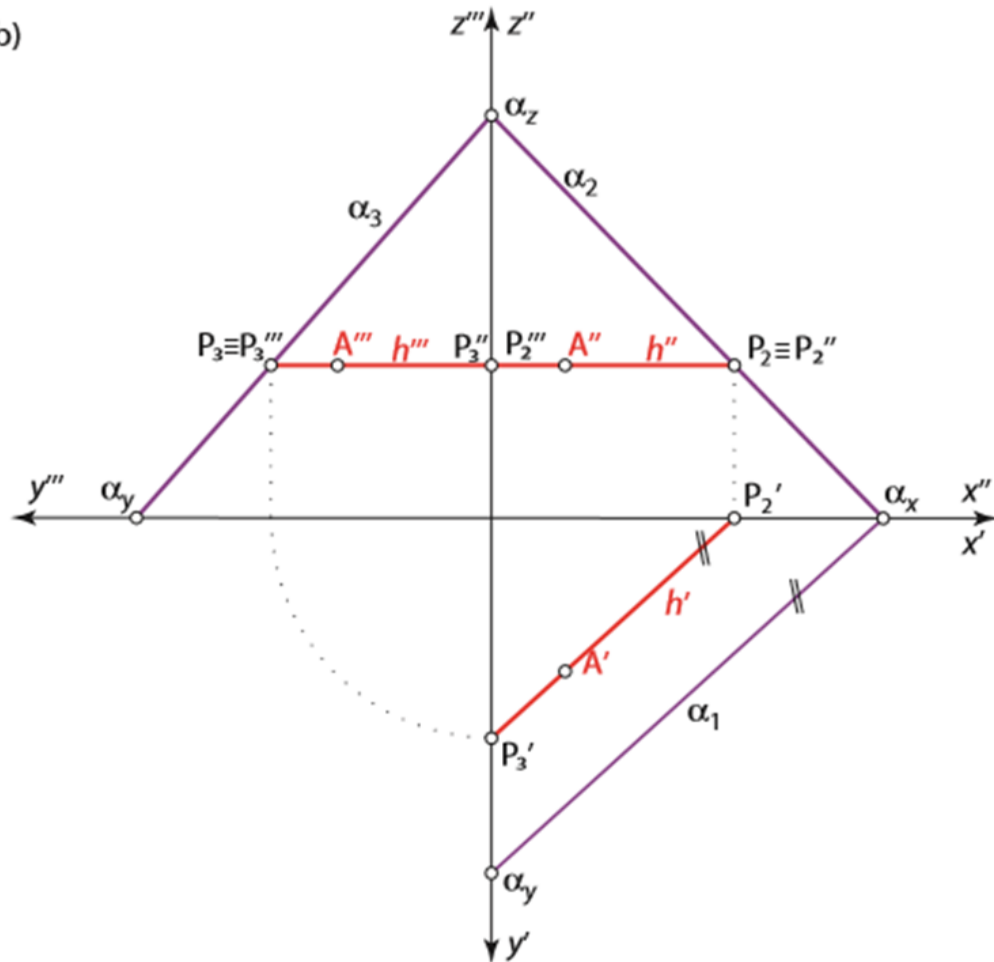

Specijalne prave u ravni – frontala (f)

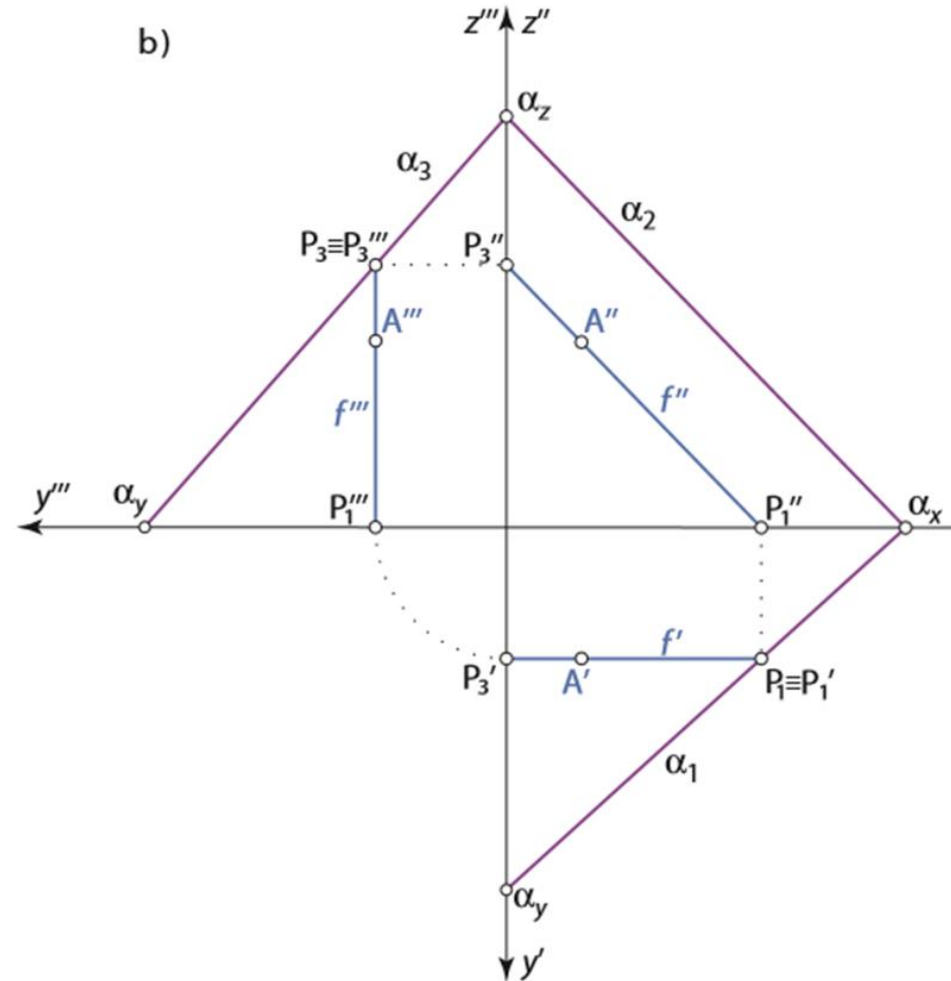
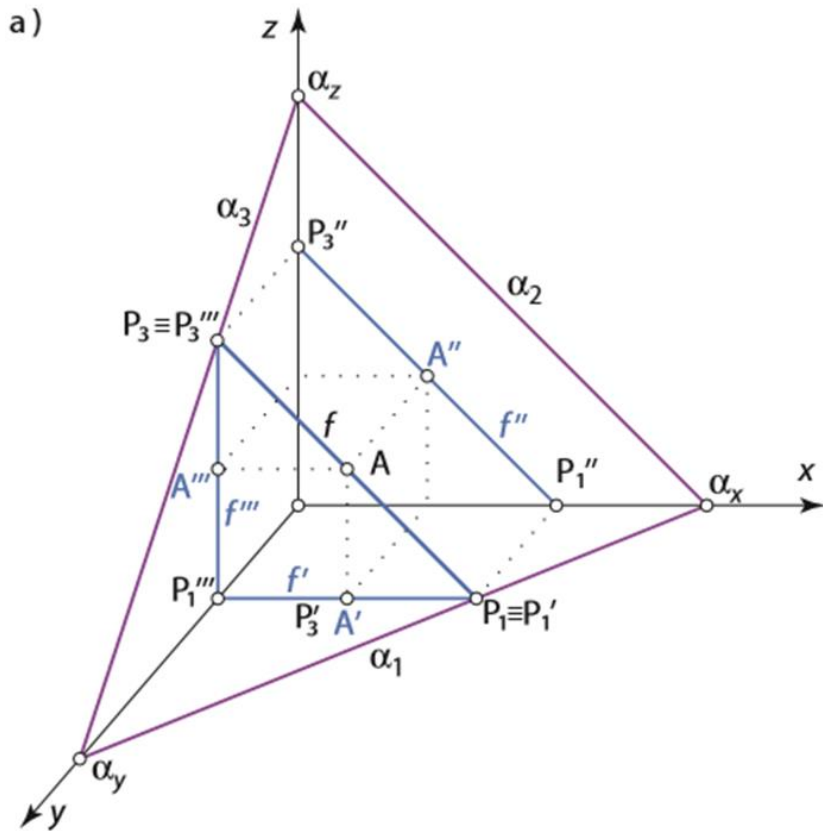

Specijalne prave u ravni – profila (p)

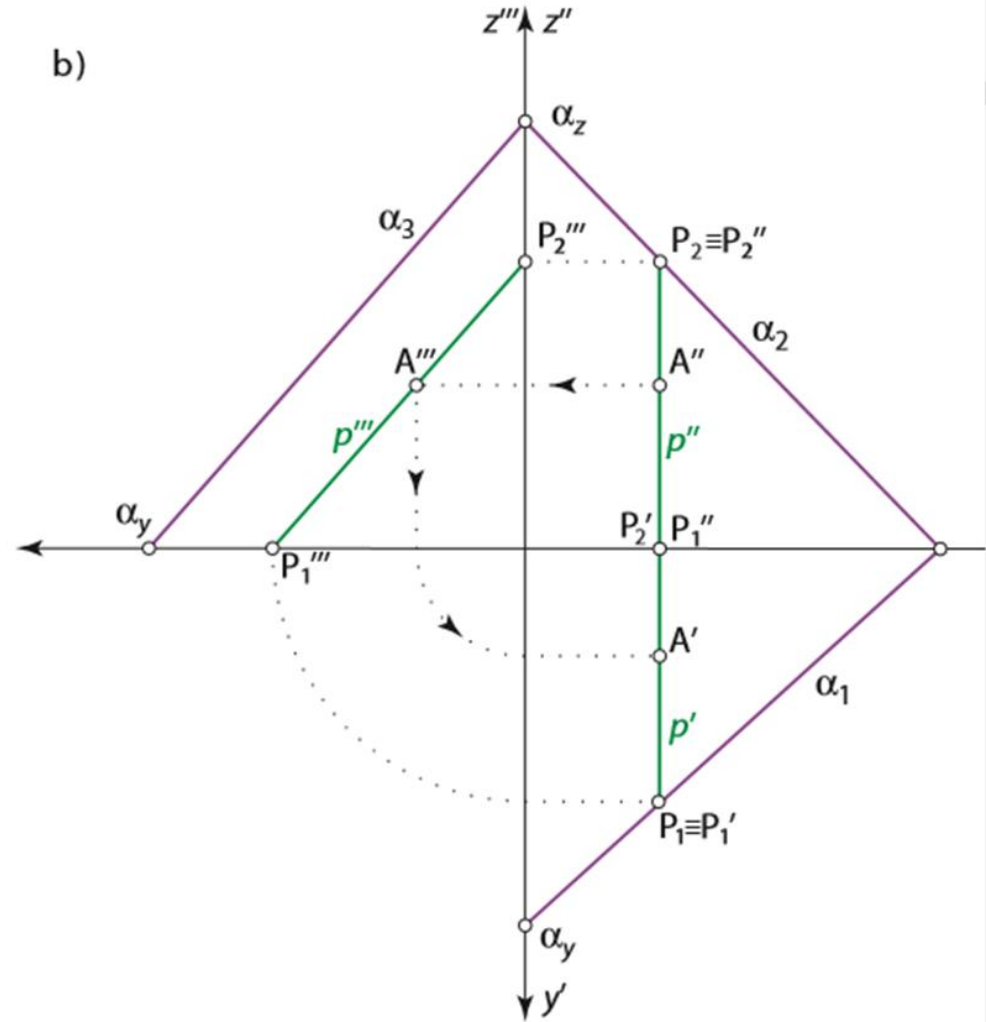
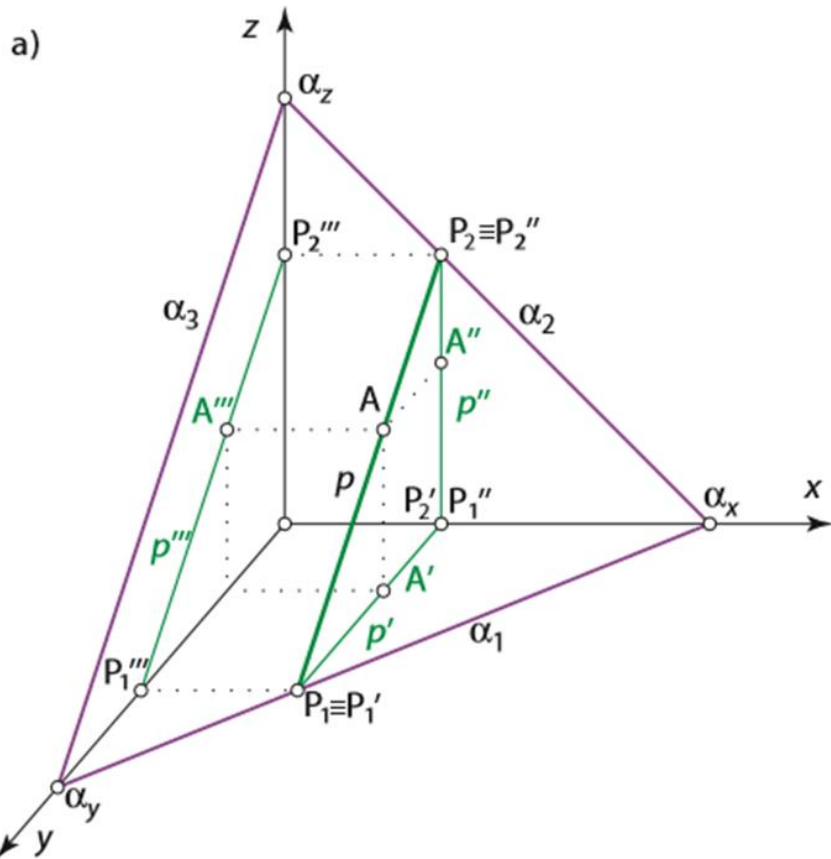

Specijalne prave u ravni – prva nagibnica (g_1)

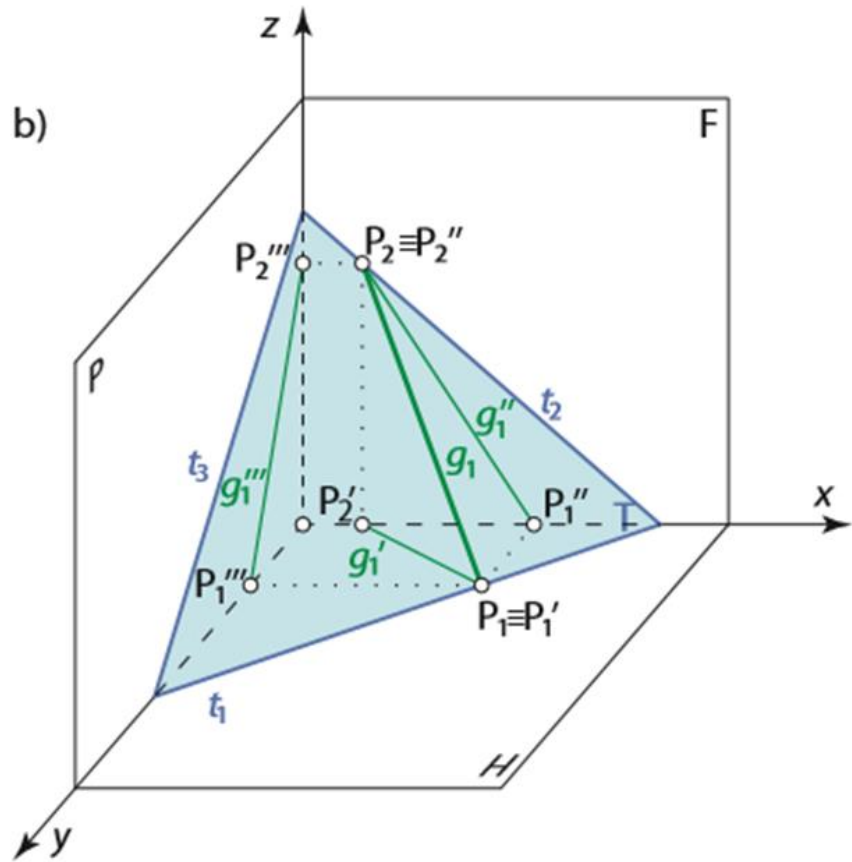
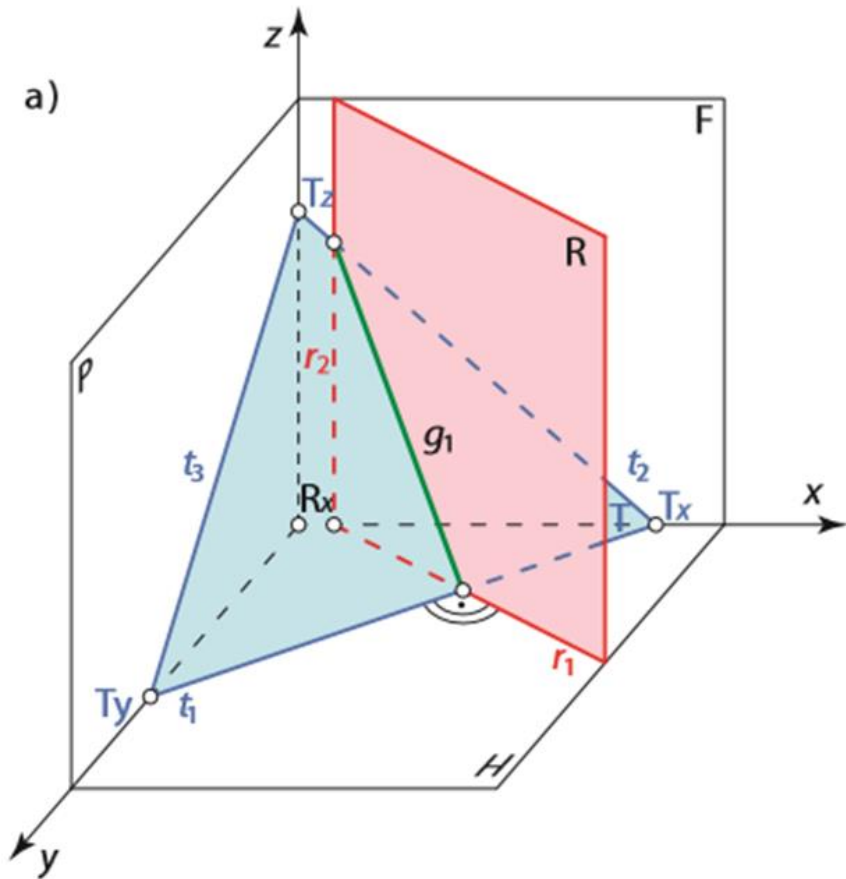
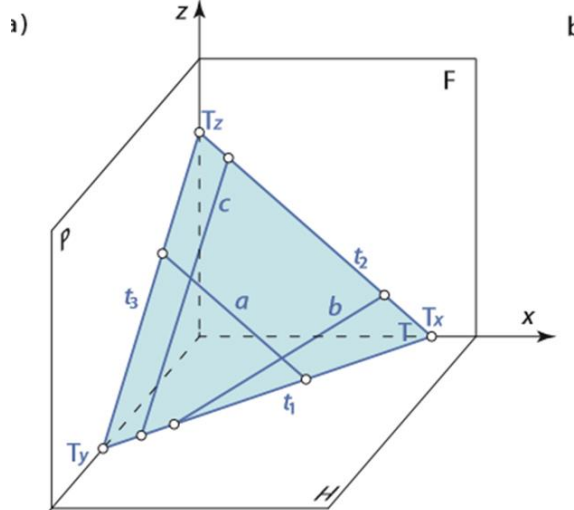

Specijalne prave u ravni – prva nagibnica (g_1)

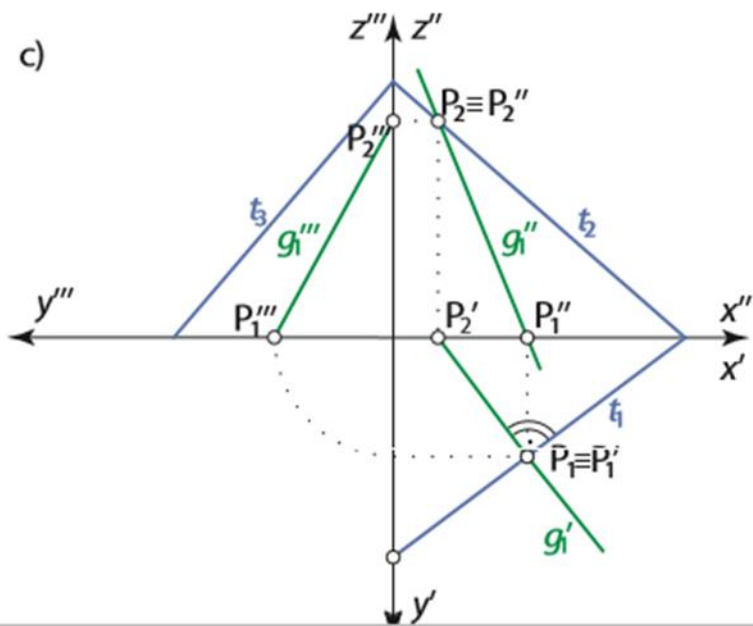
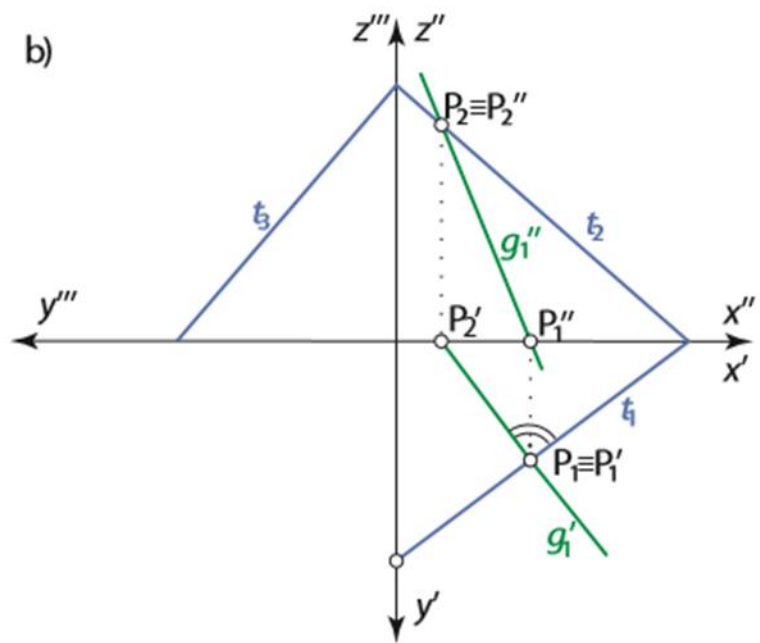
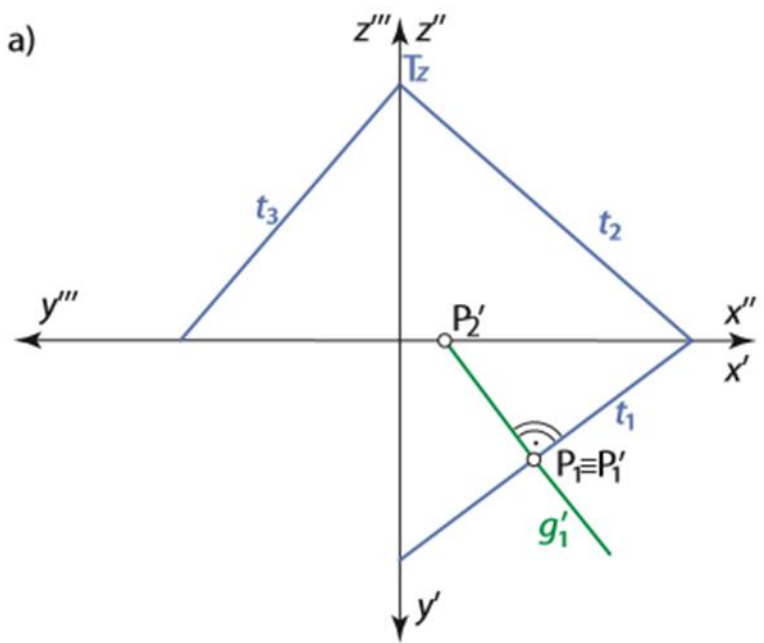

Specijalne prave u ravni – druga nagibnica (g_2)

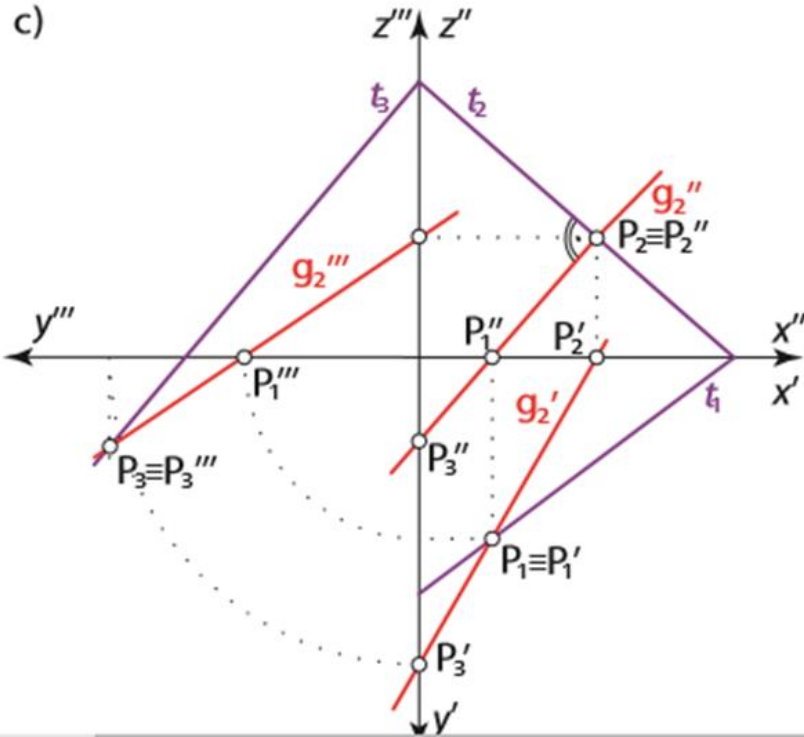
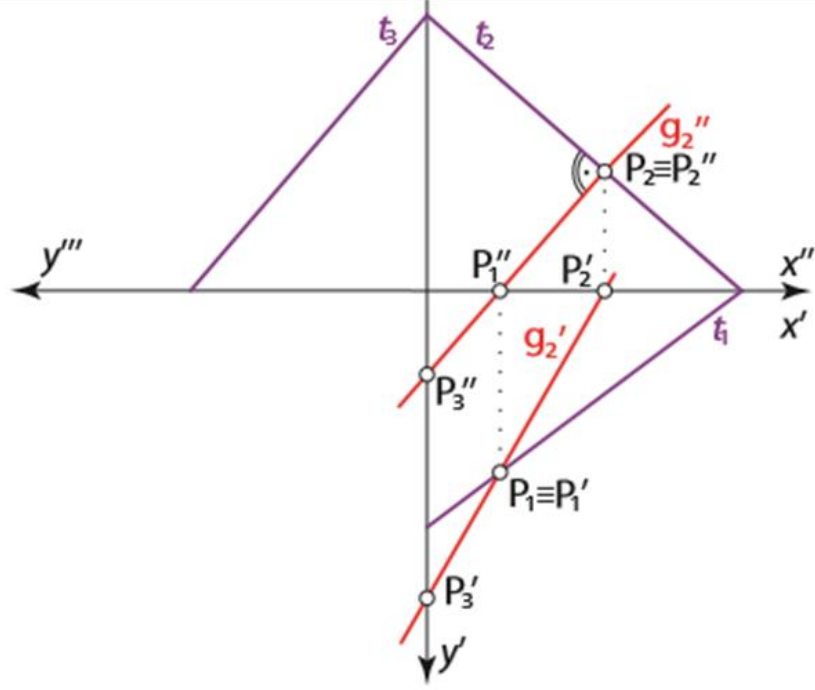
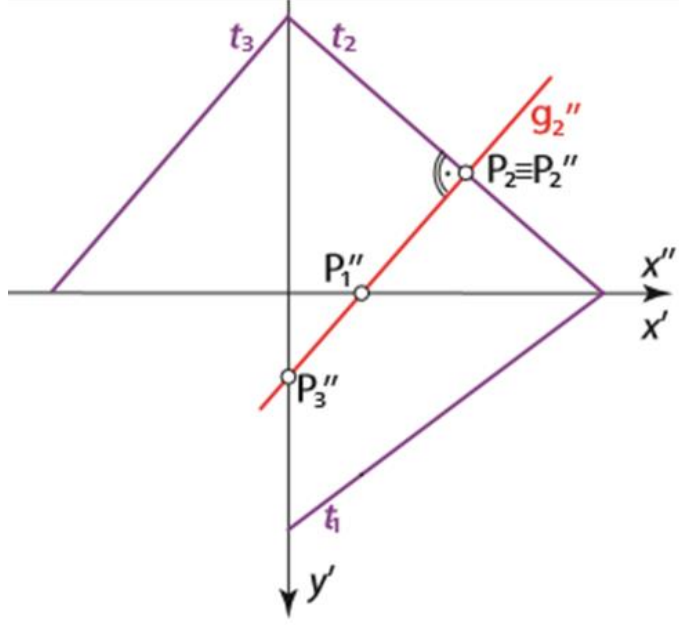

Specijalne prave u ravni – treća nagibnica (g_3)

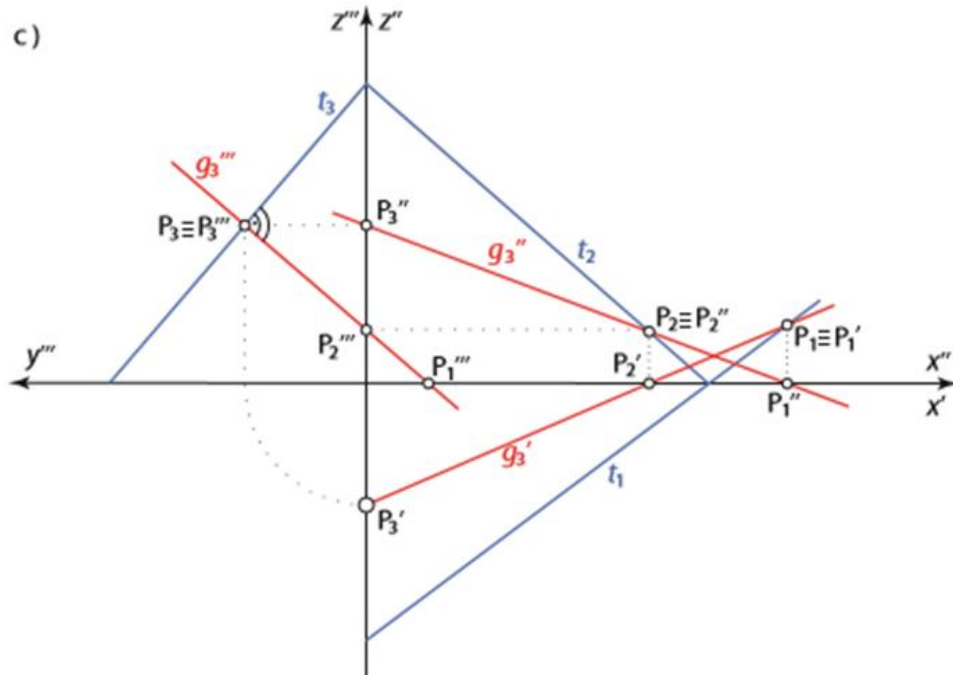
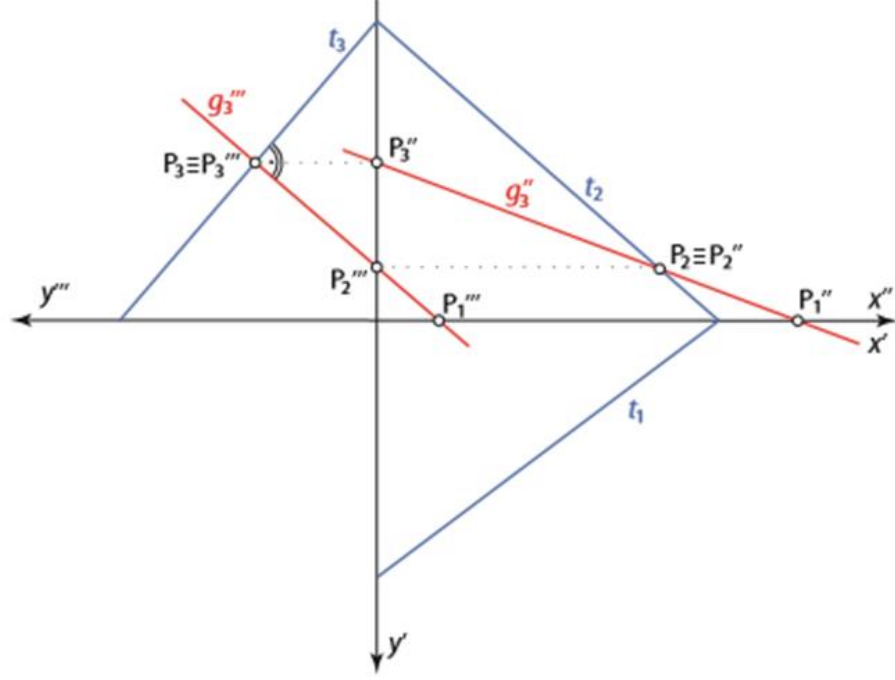
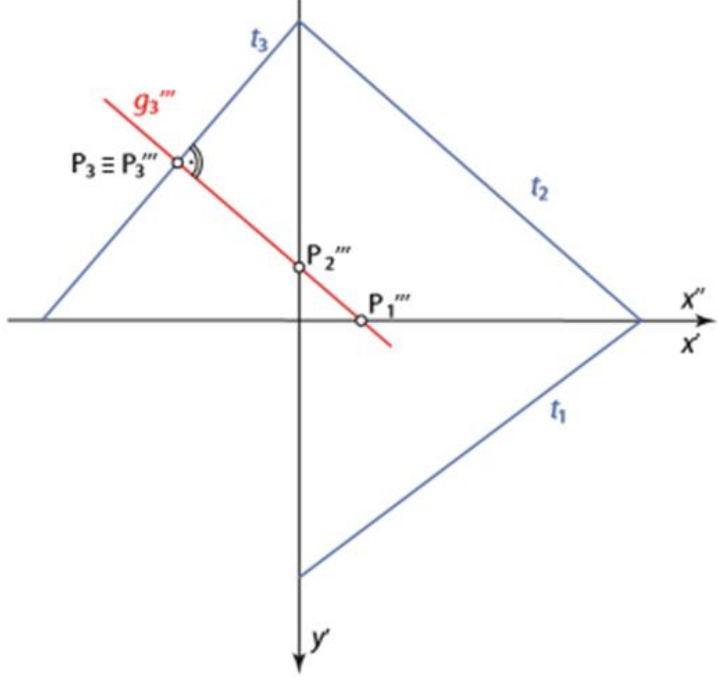

Normala (n) – prava upravna na ravan

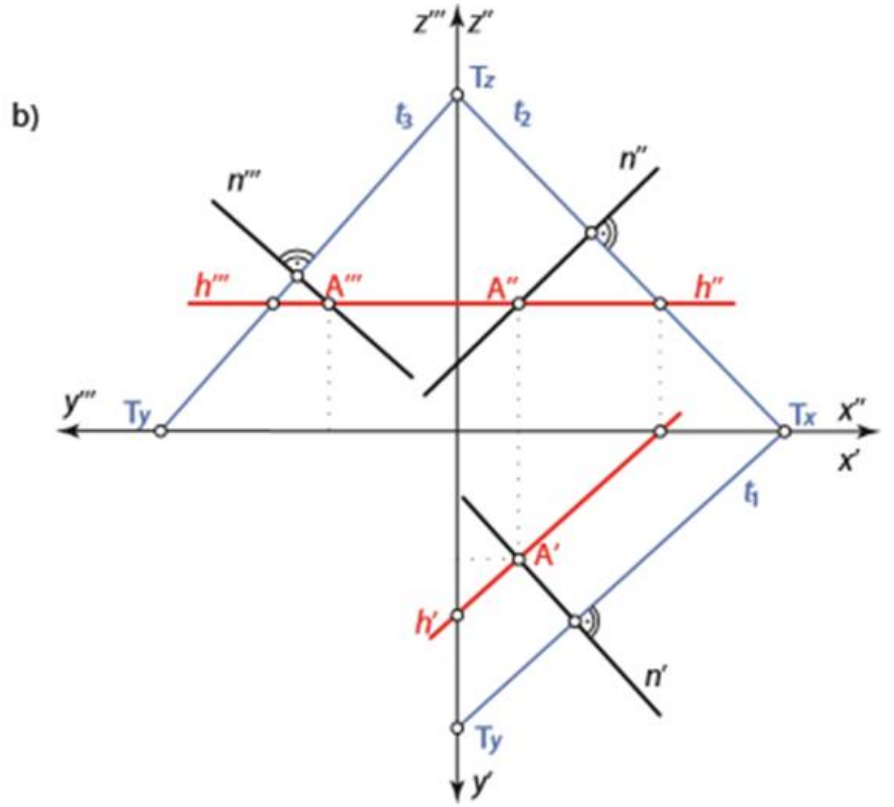
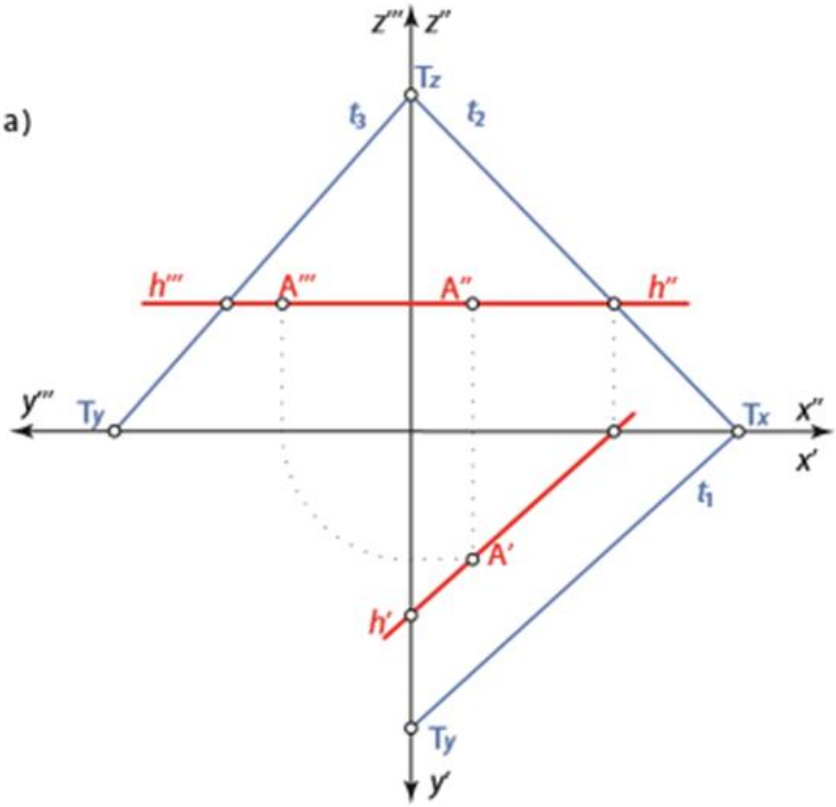
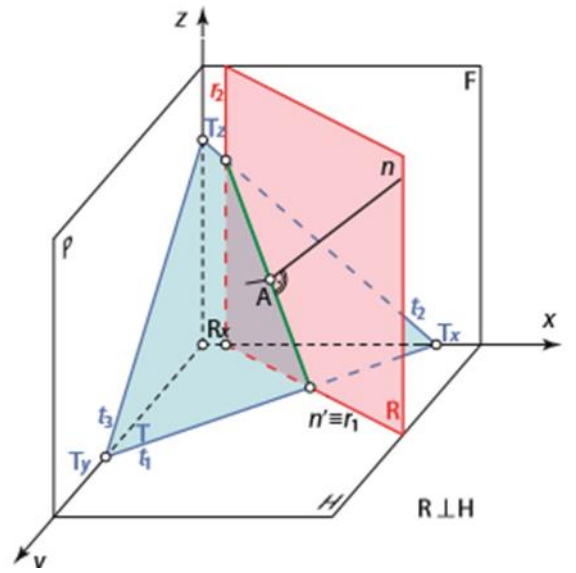

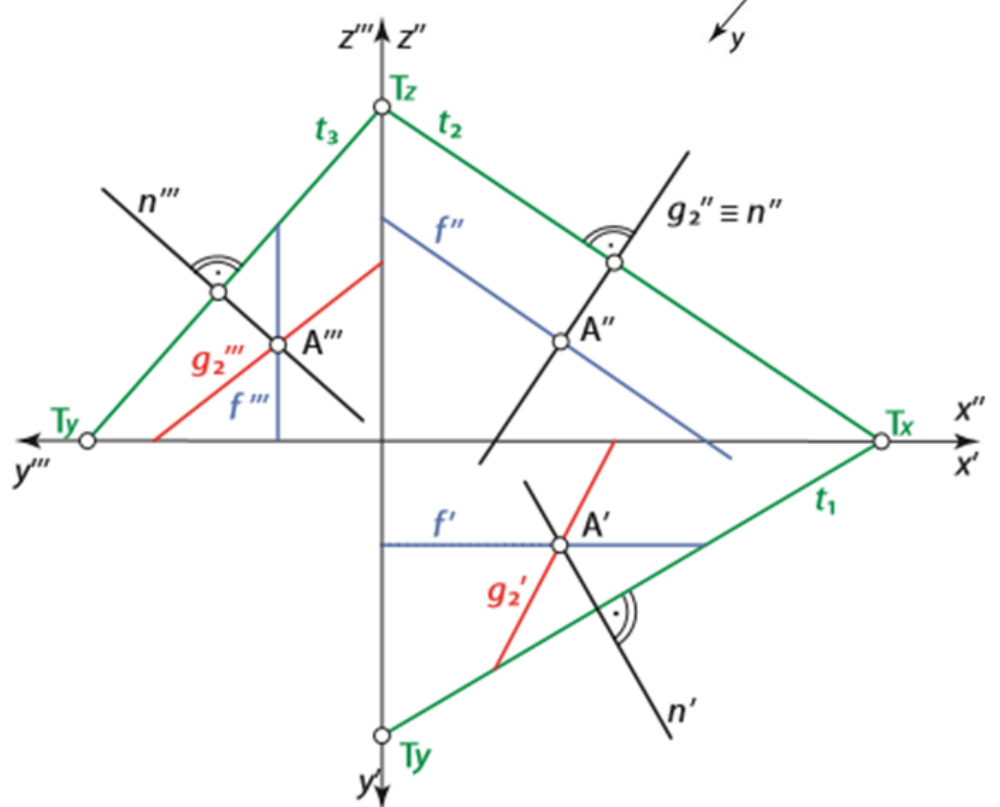
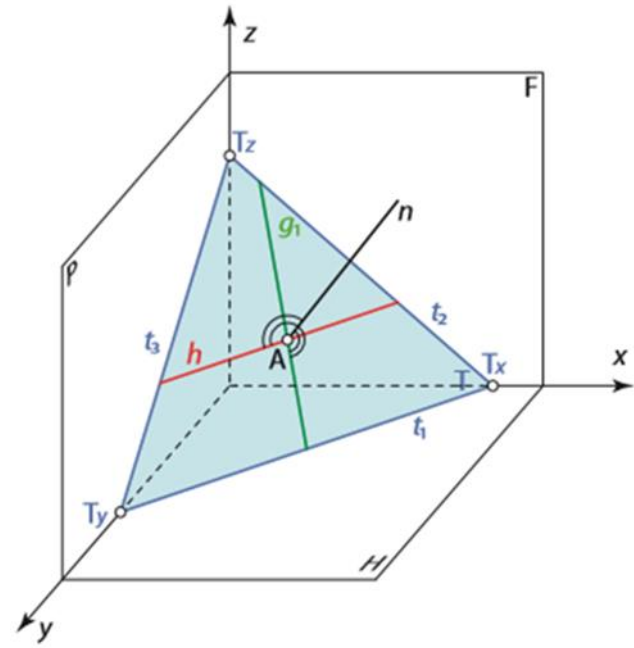

Nagibni triedri

Postupci određivanja prave veličine duži i uglova

- Transformacija
 - Rotacija
- Obaranje ravni

Prava, duž

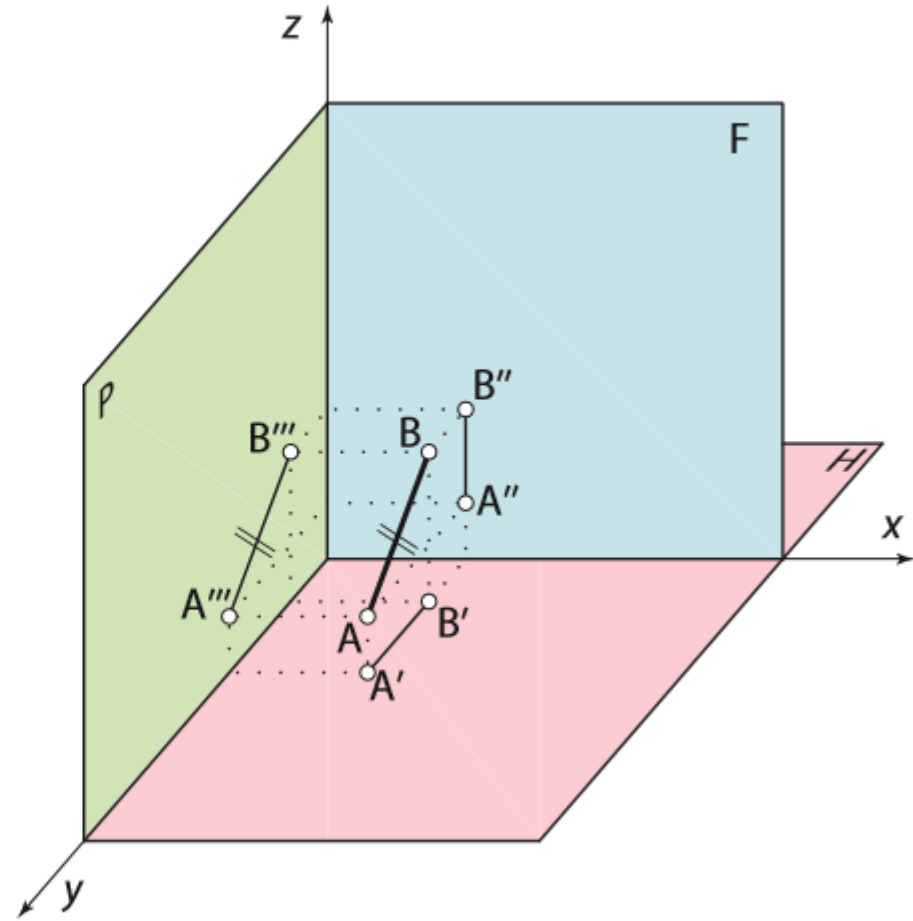
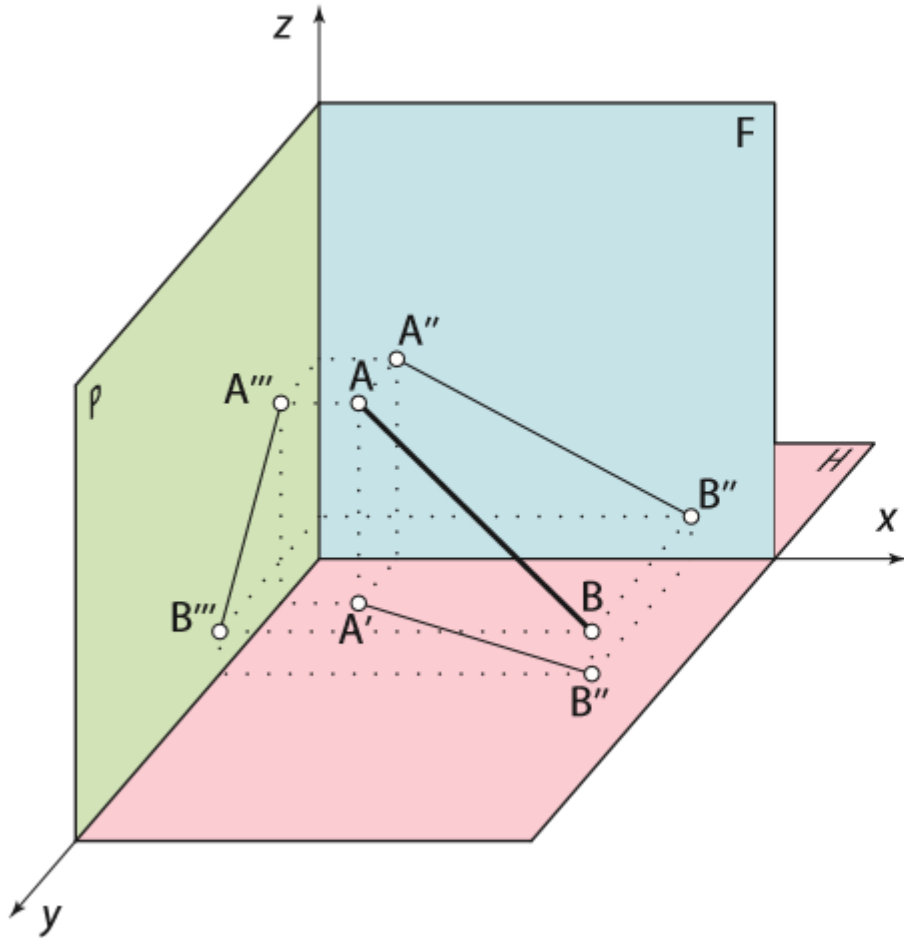

Transformacija

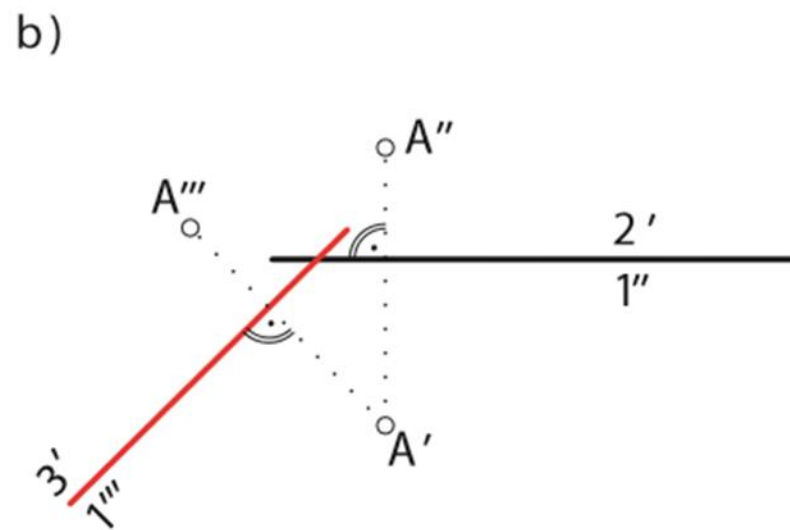
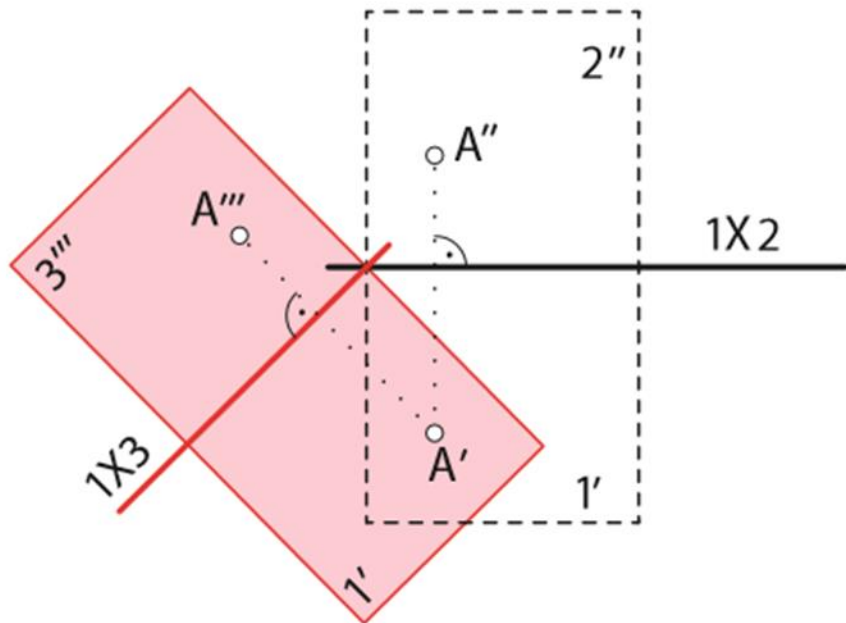
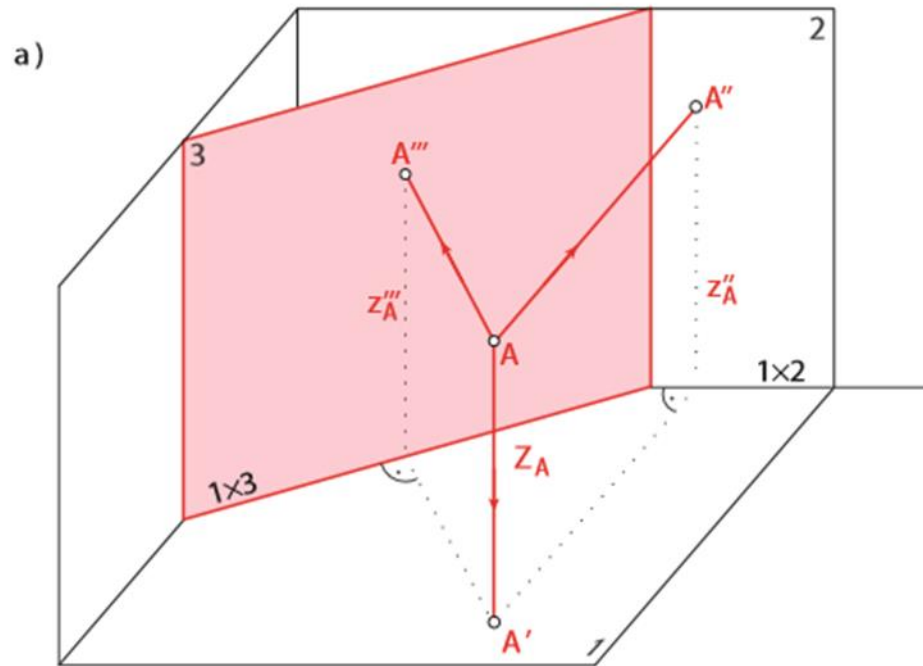
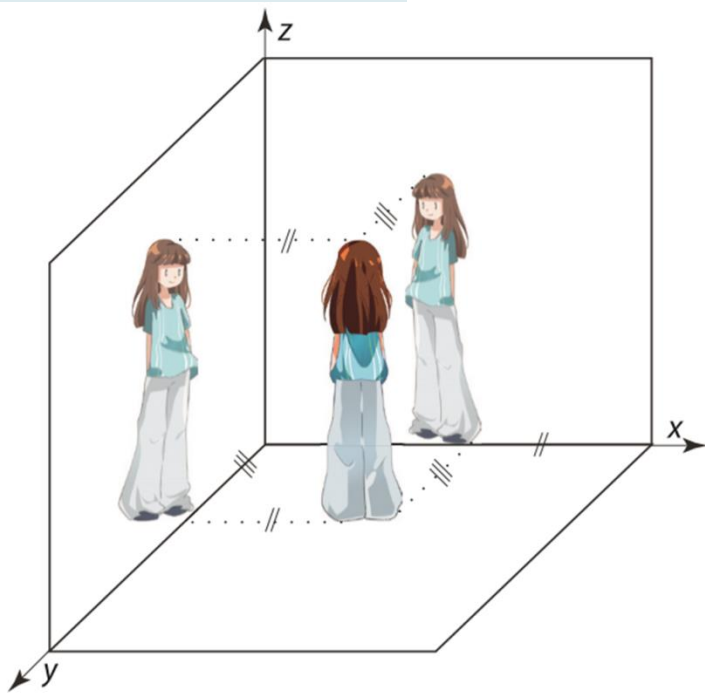

Određivanje prave veličine duži i ugla - transformacija

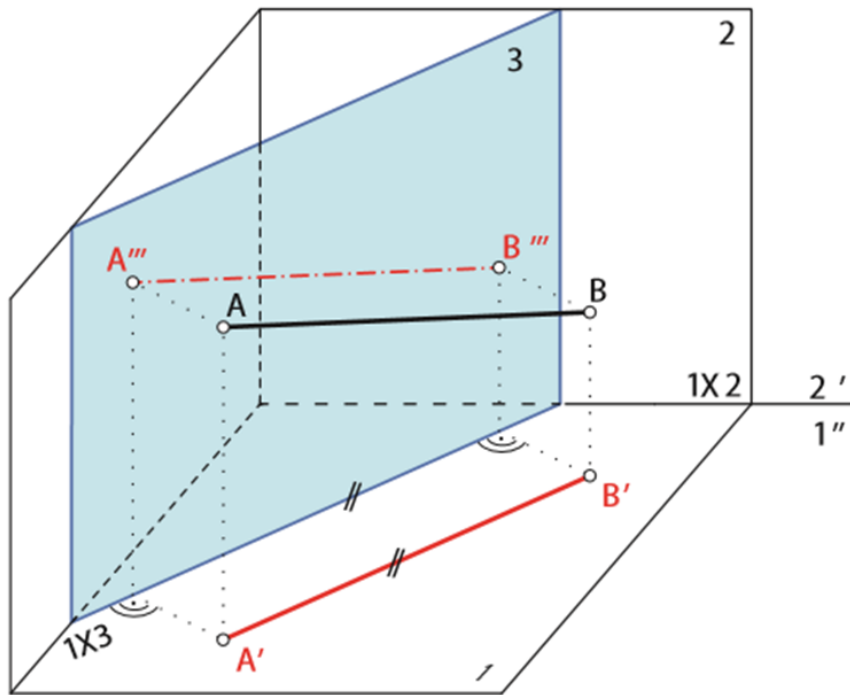

b)

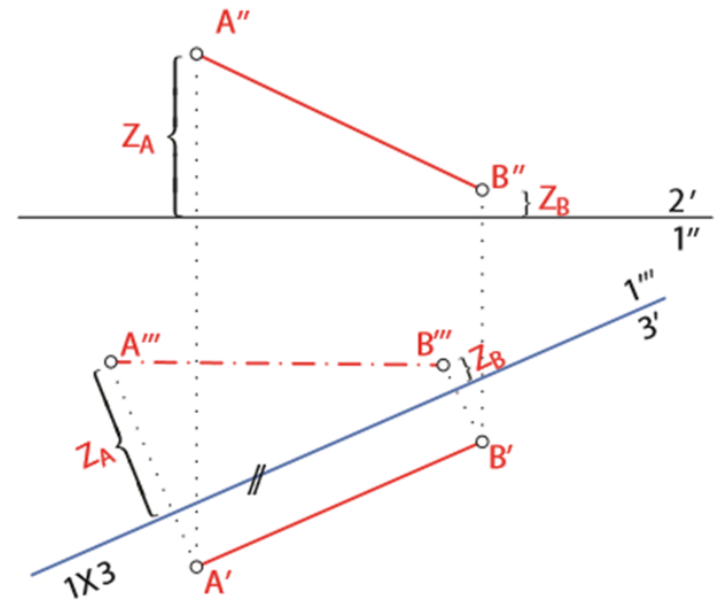

Određivanje prave veličine trougla - transformacija

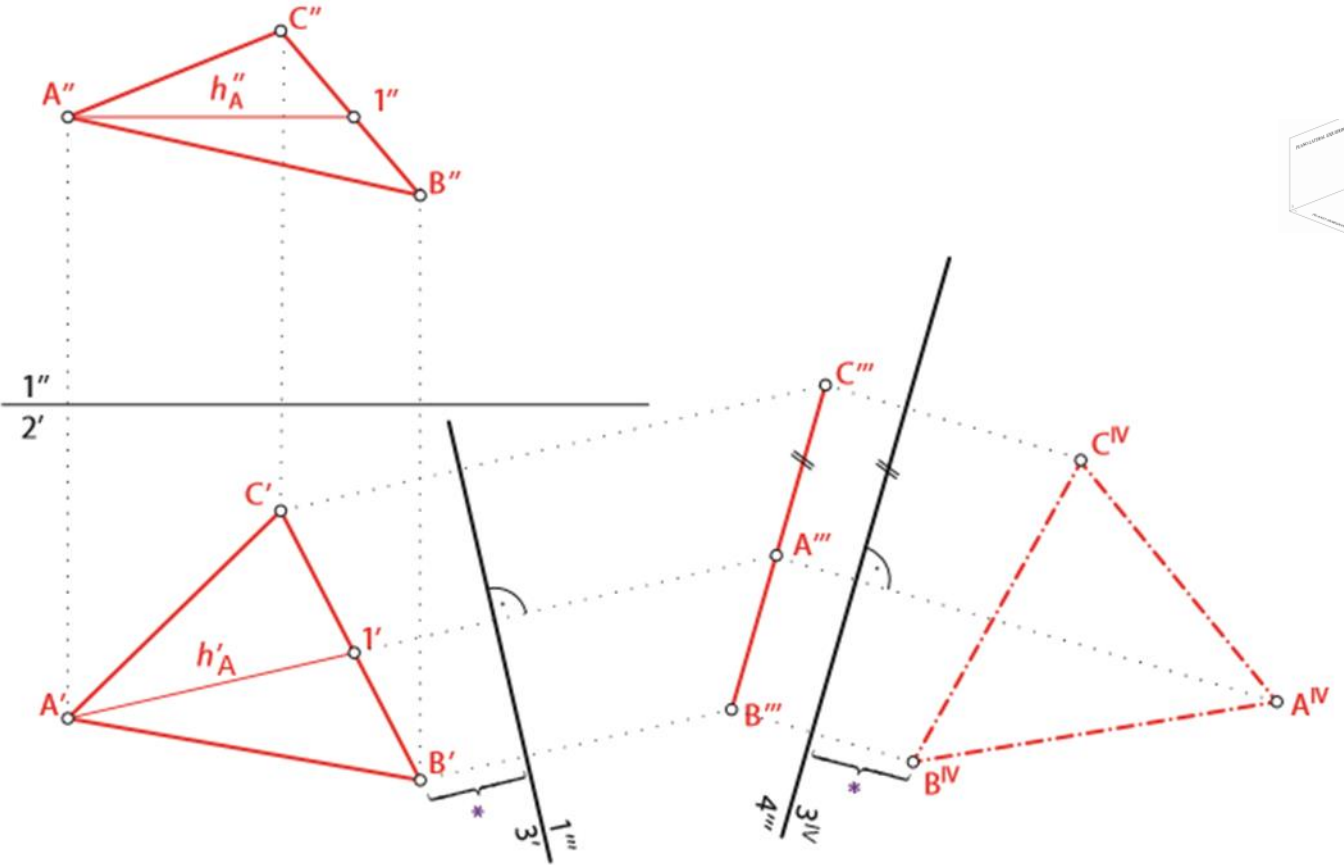
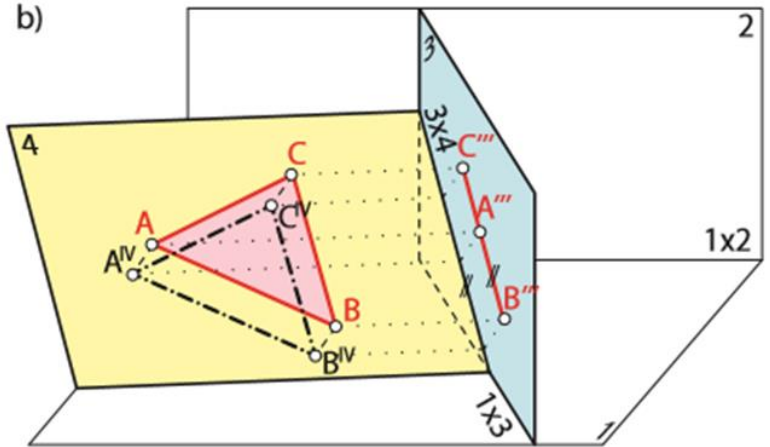
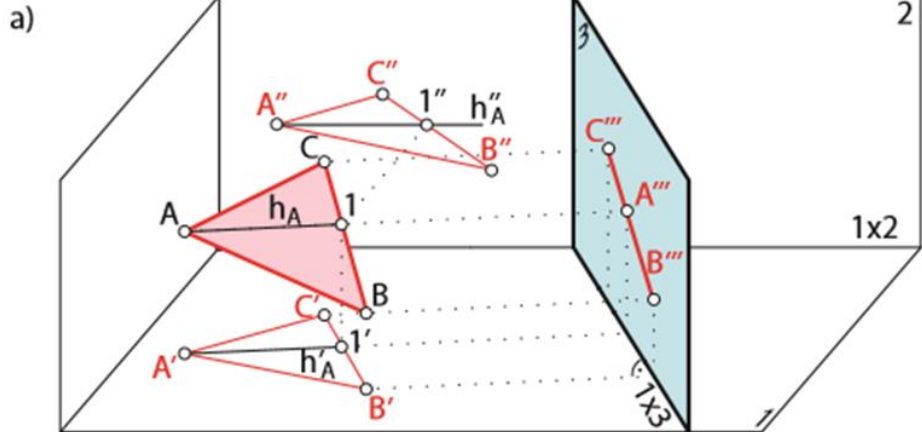

Rotacija

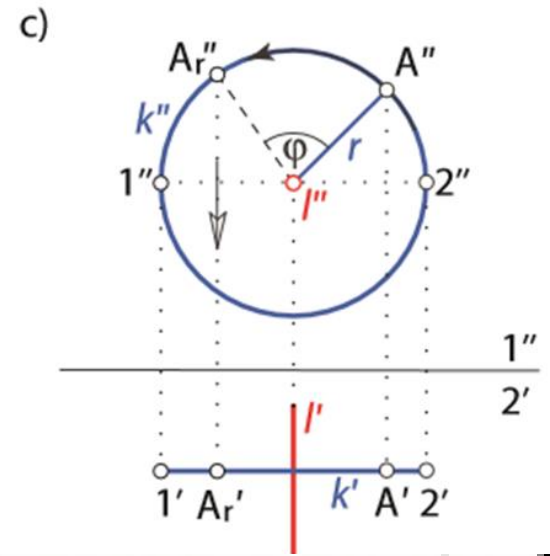
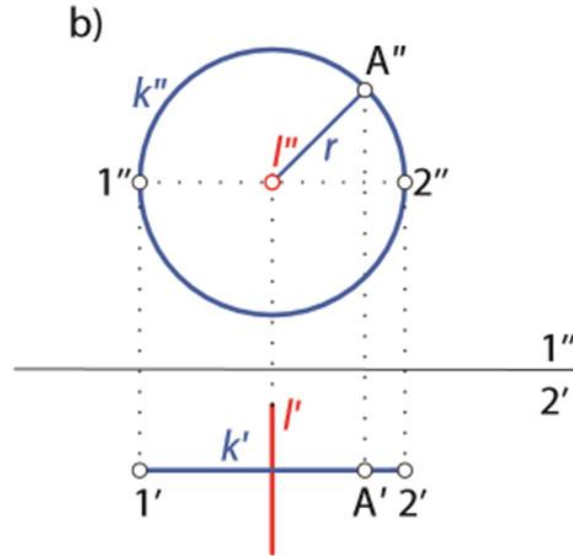
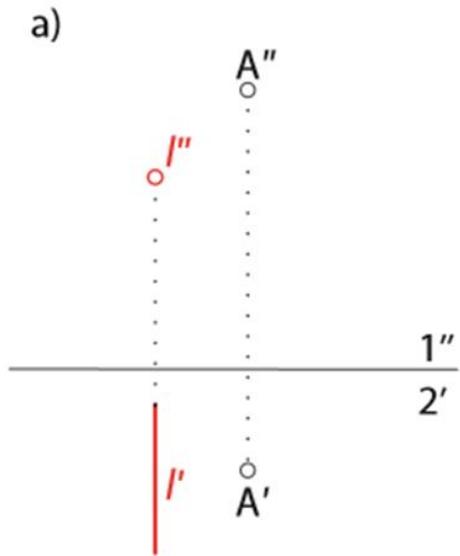
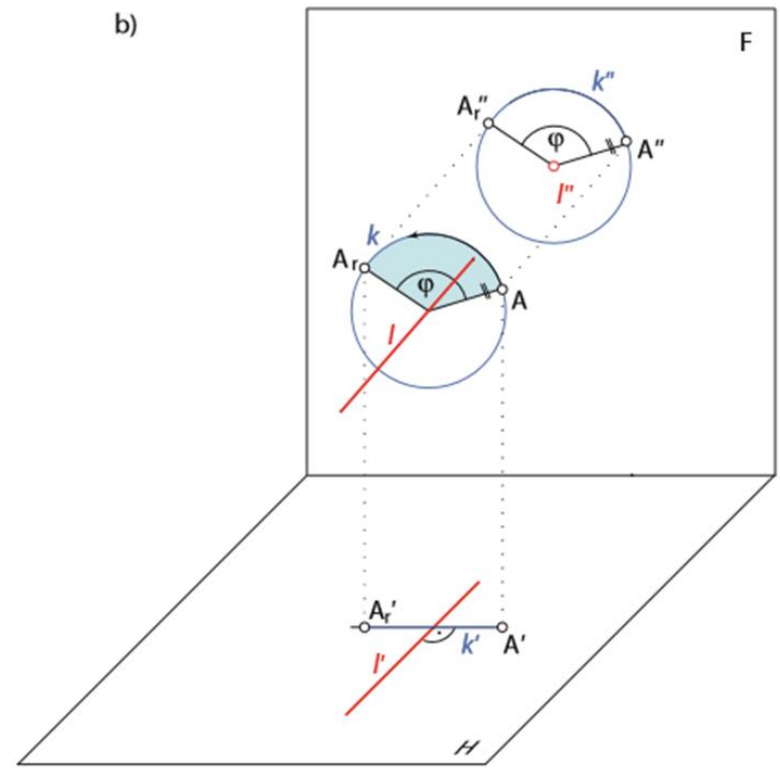
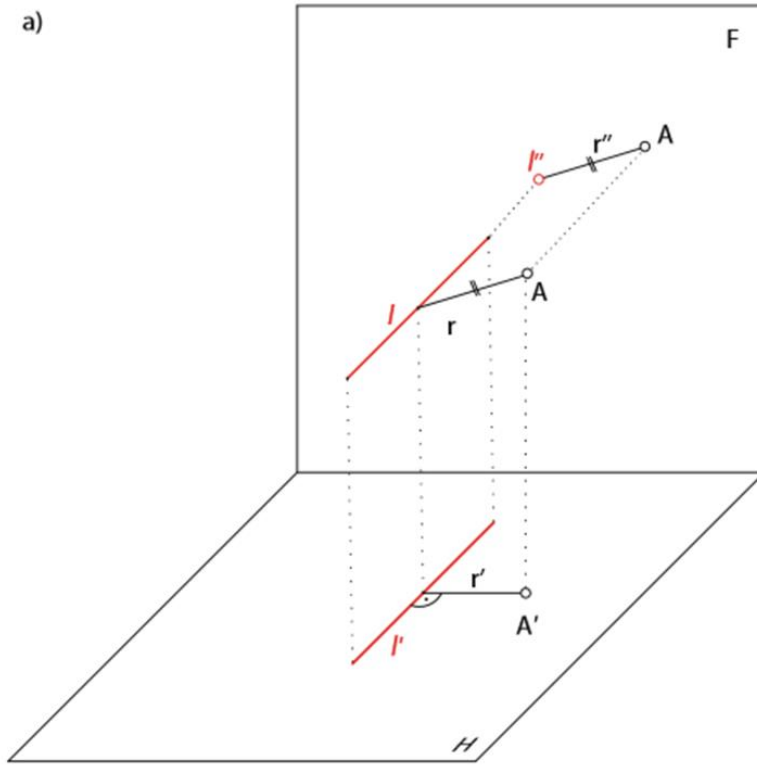

Obaranje ravni

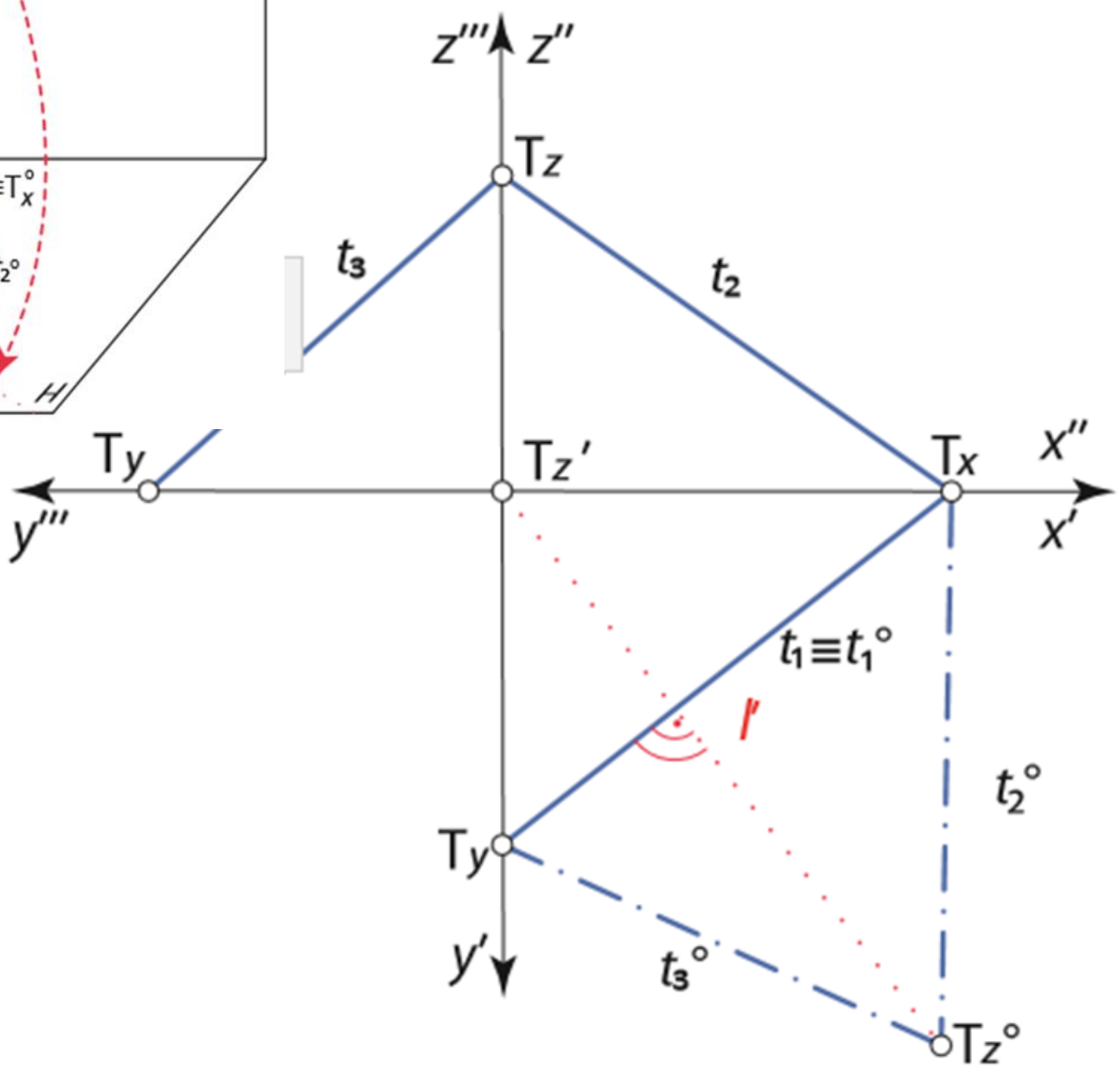
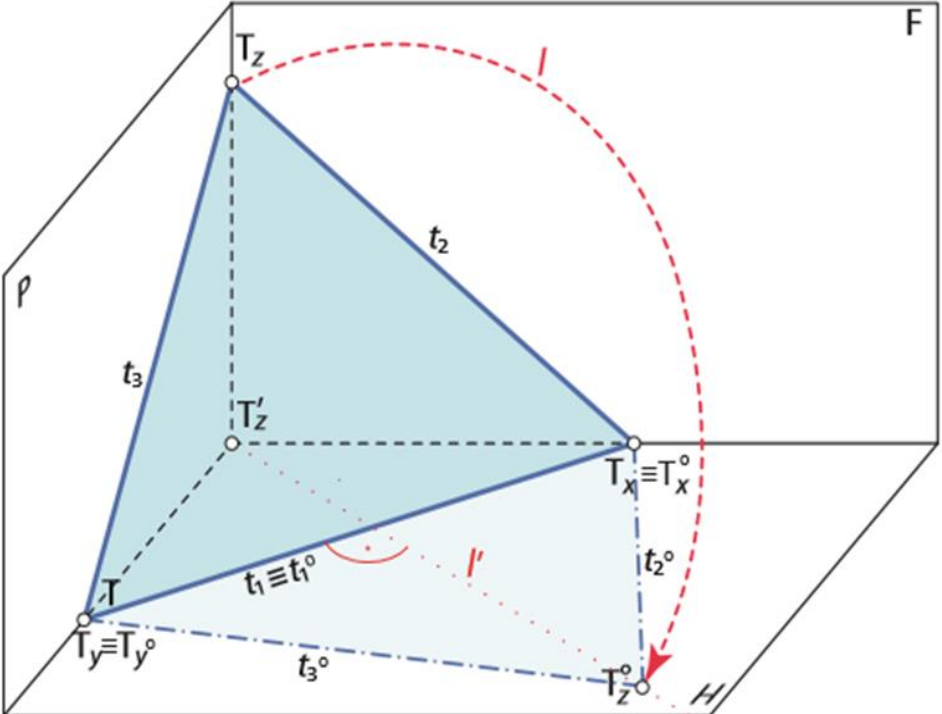

Obaranje ravni

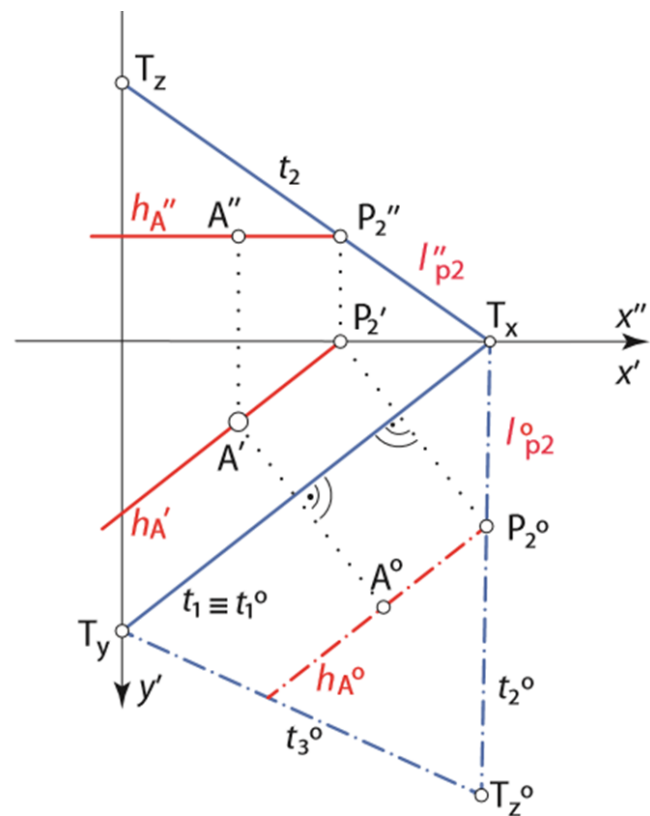
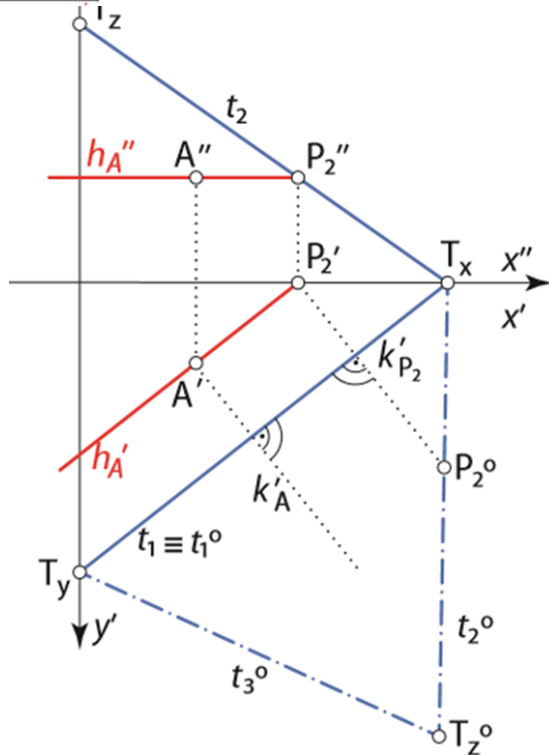
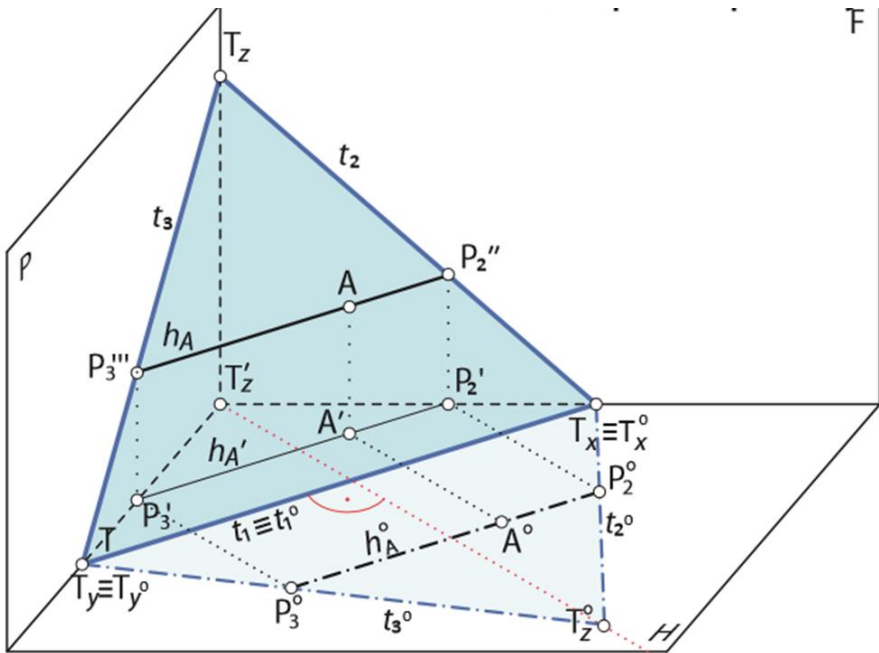

Konstrukcija pravilnih mnogouglova

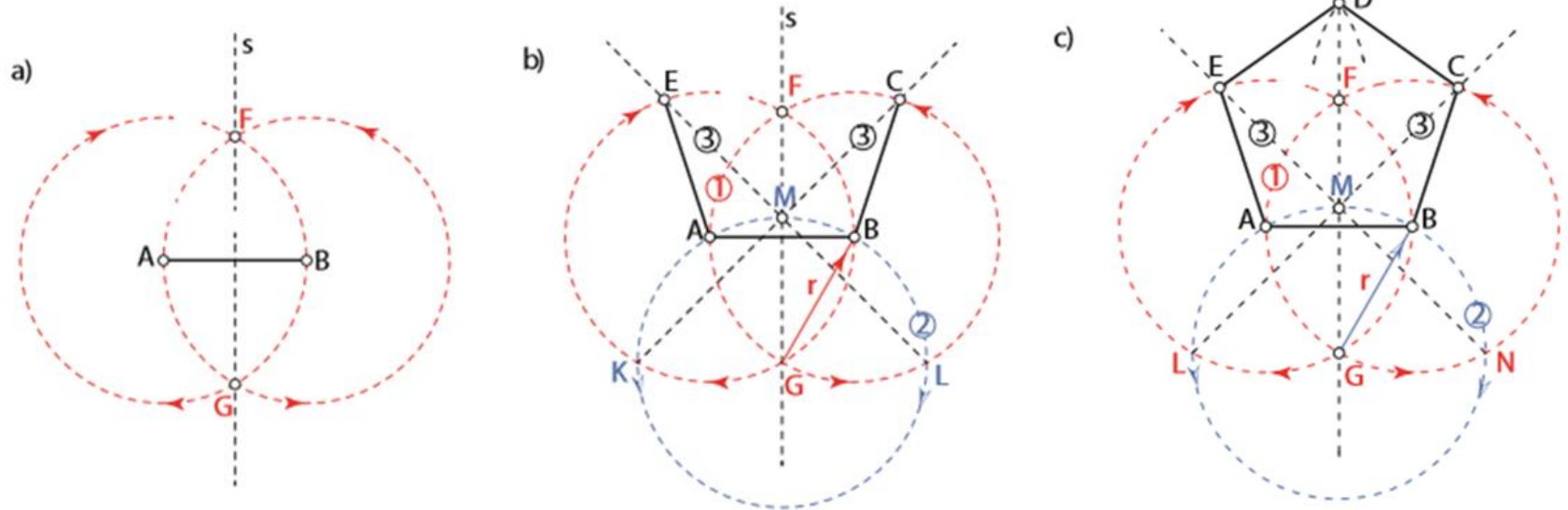
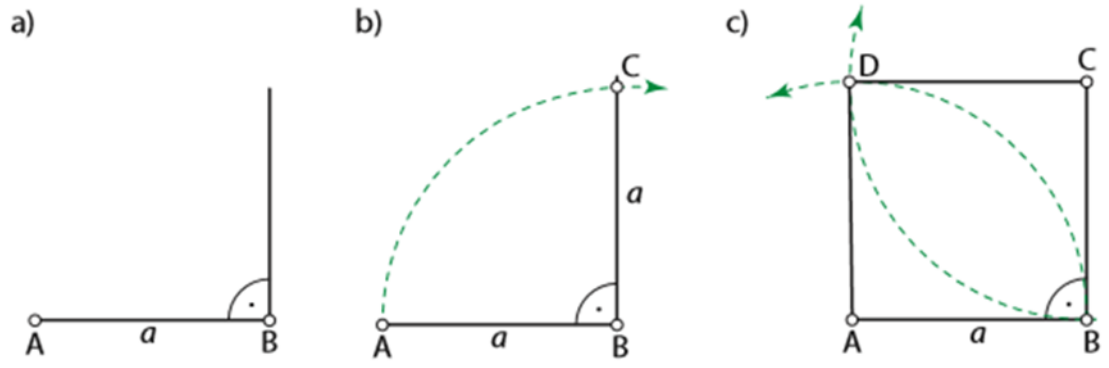
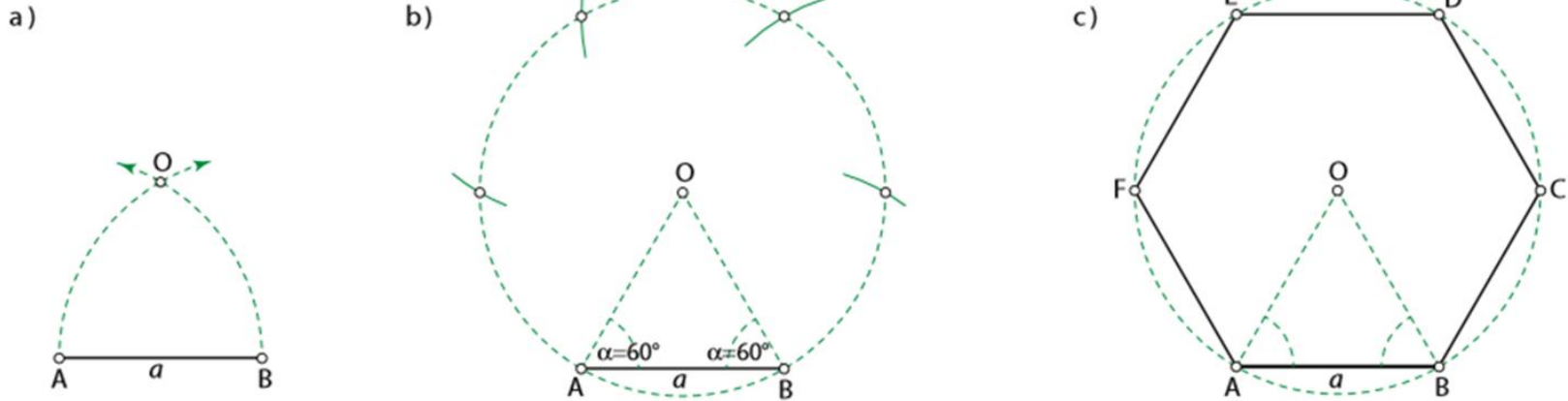

Konstrukcija elipse nad parom prečnika

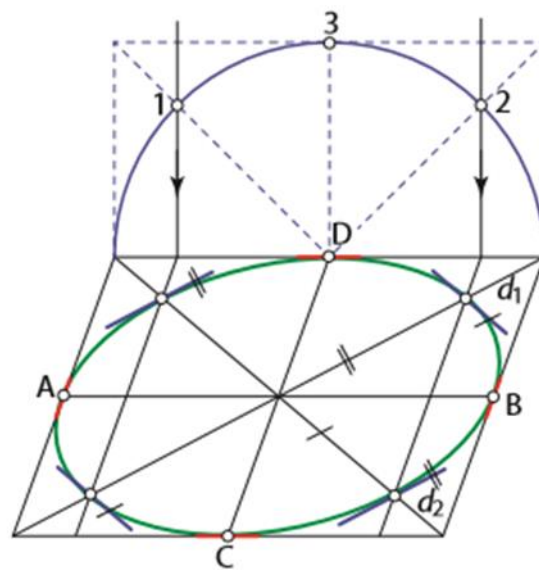
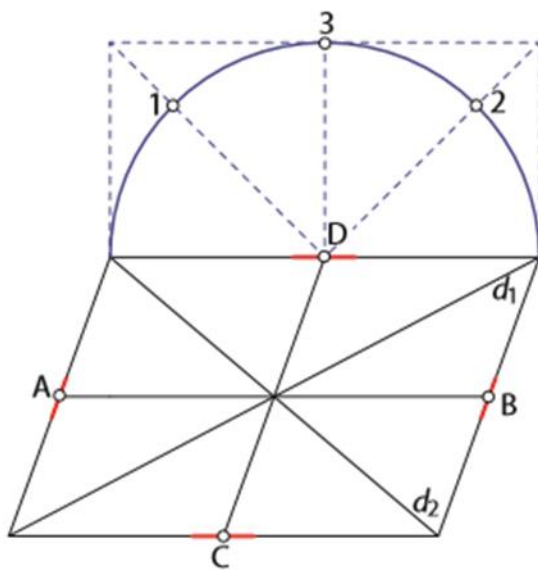
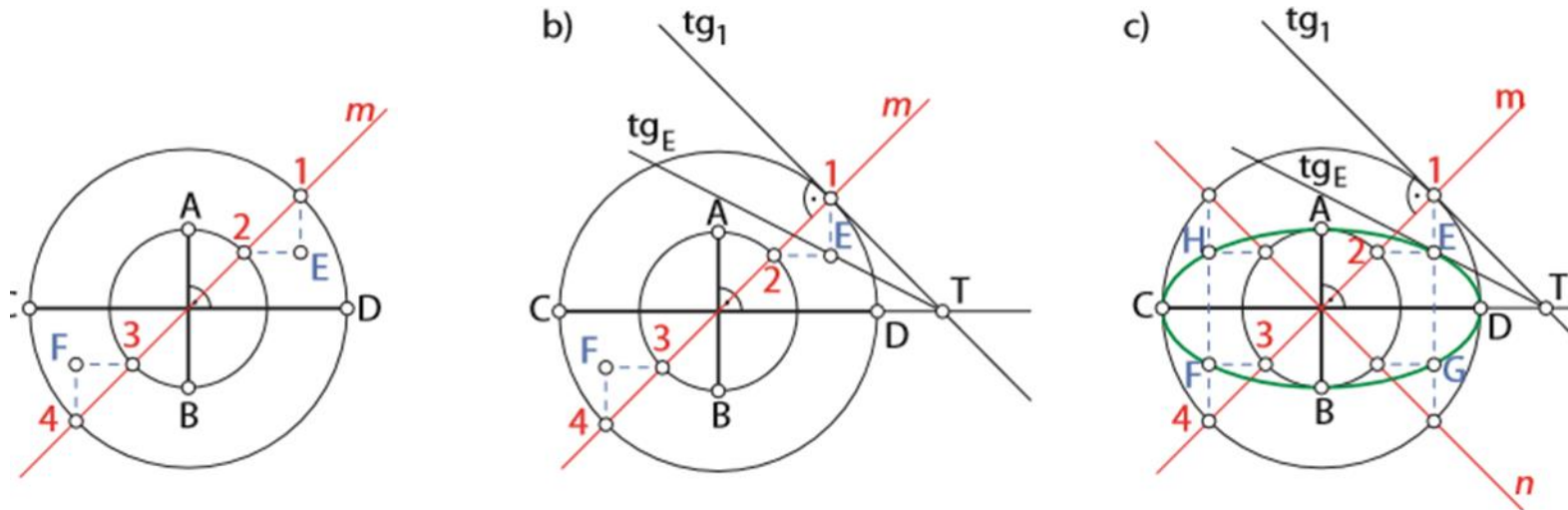

Šestougao na kosoj ravni

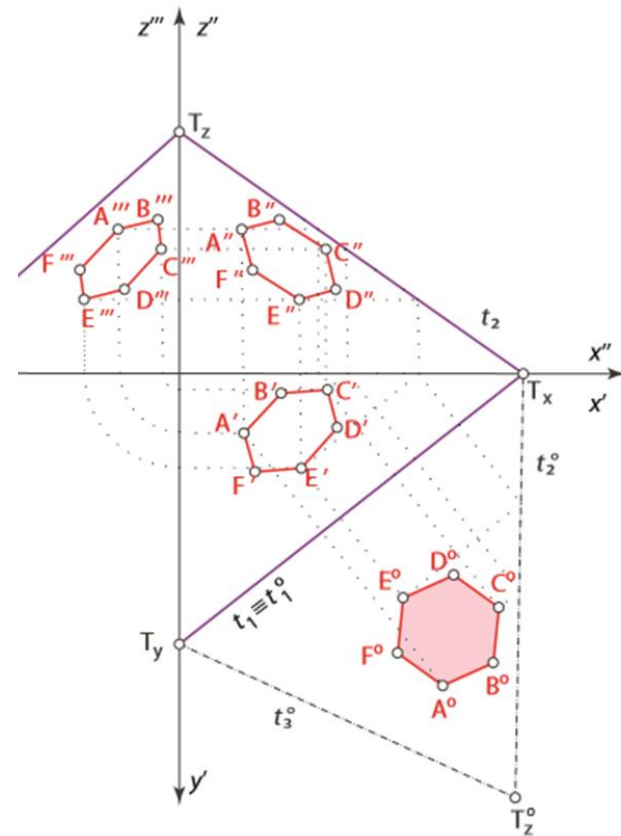
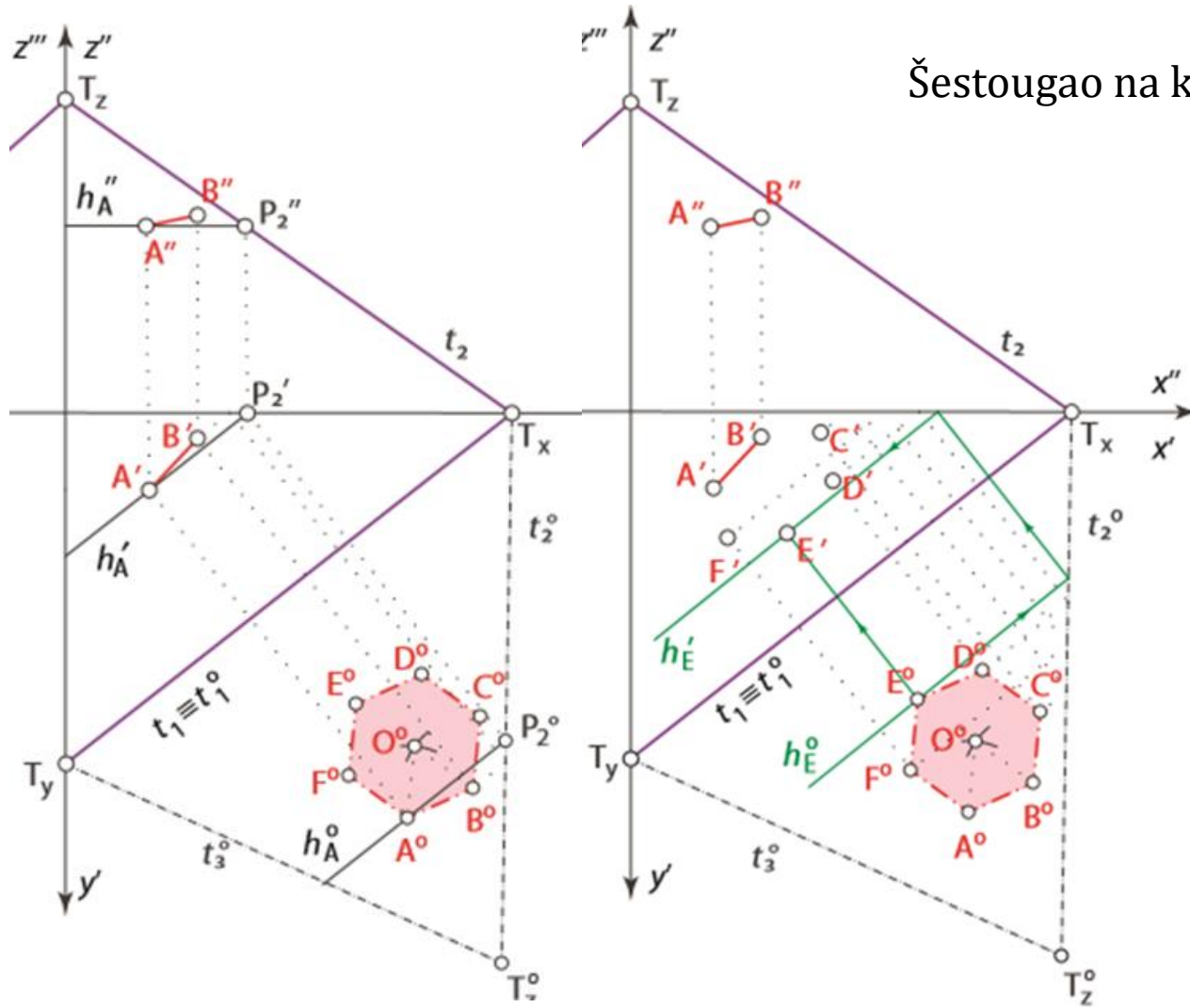

Geometrijske površi



Kanton toranj (Kina) –
jednograni hiperboloid



Agbar toranj (Španija) –
rotacioni paraboloid



Rotirajući torzo (Švedska)
– zavojna površ

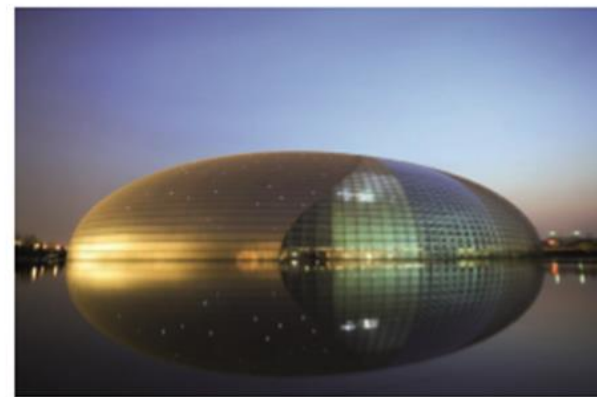

Opera (Kina) –
rotacioni elipsoid

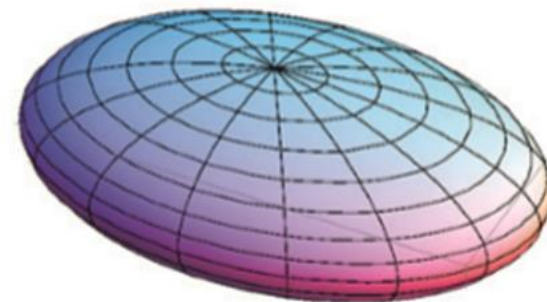
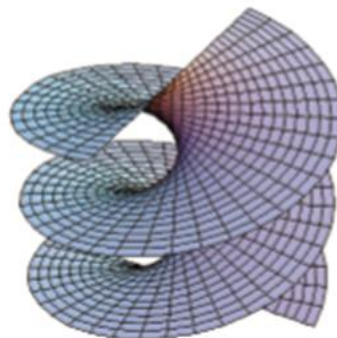
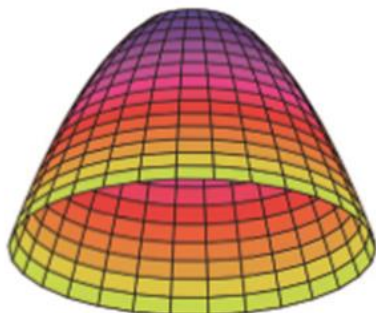
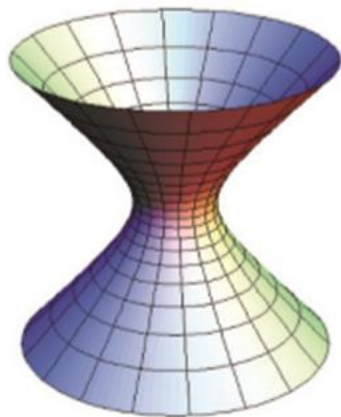

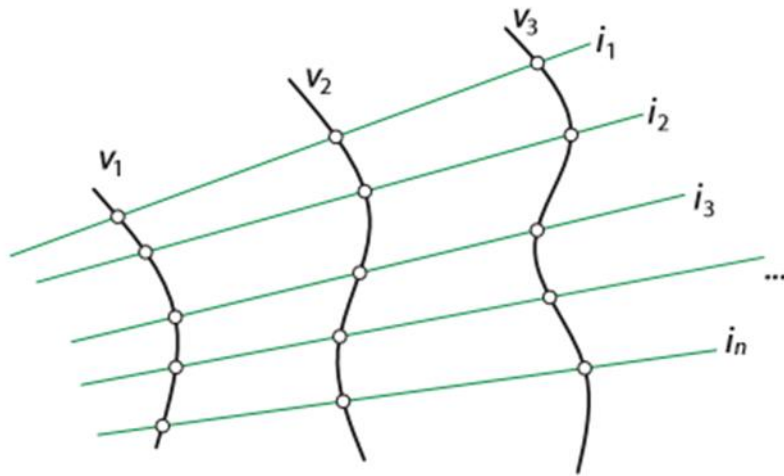

Pravoizvodne površi

rogljaste površi

piramidalne

prizmatične

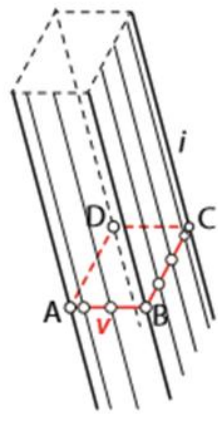
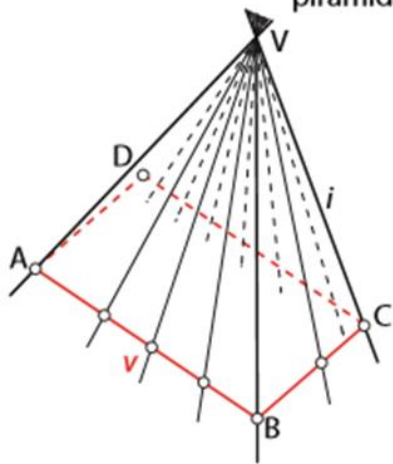

oble površi





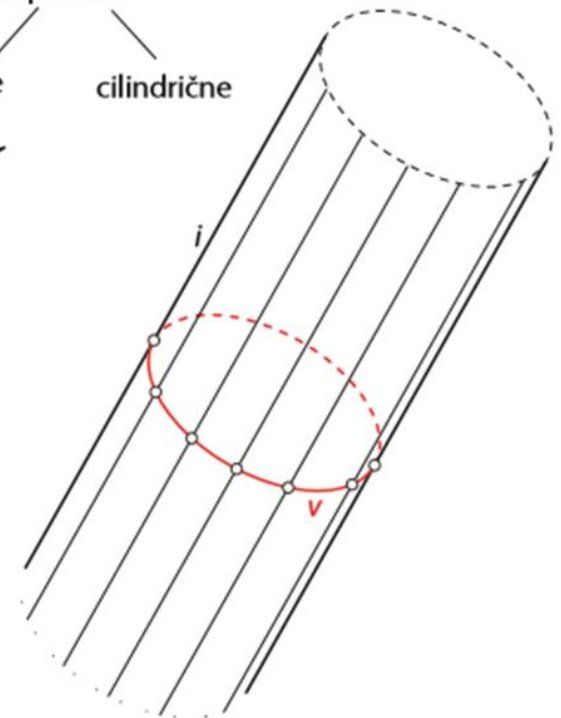
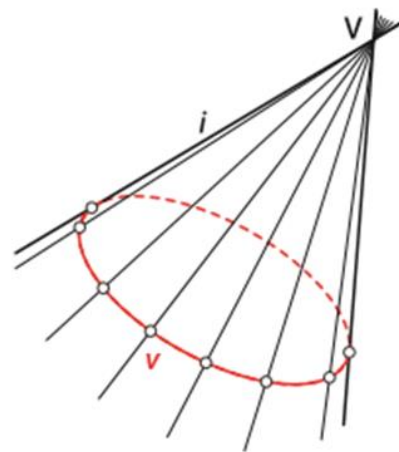

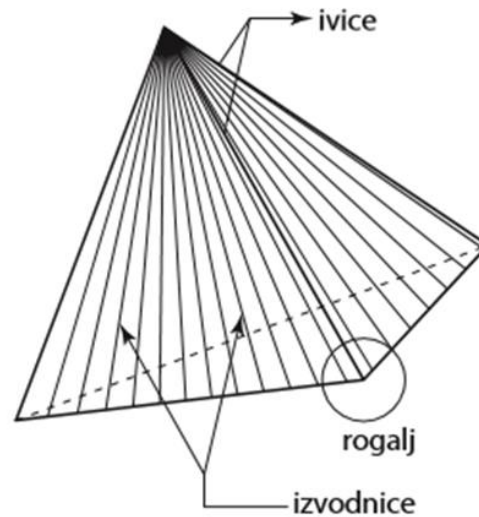
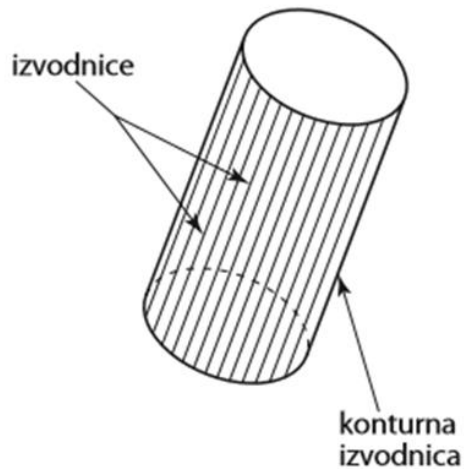
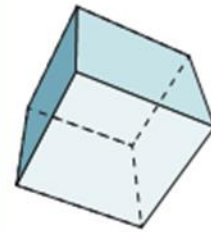
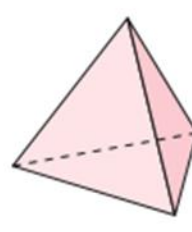
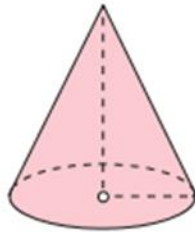
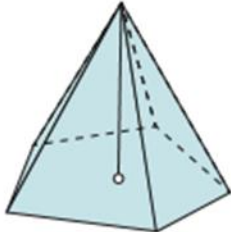
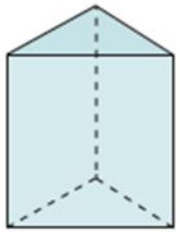
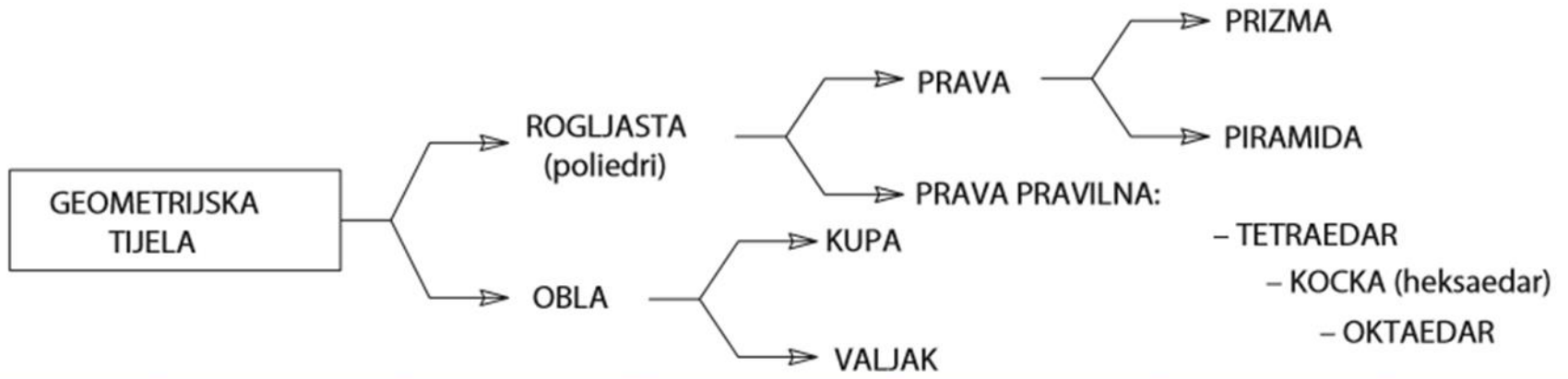
konusne

cilindrične



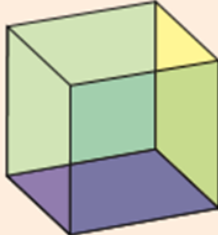

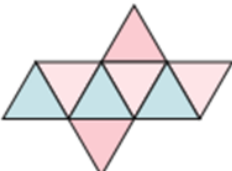
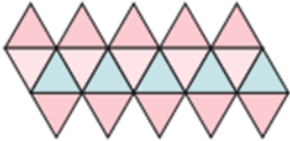
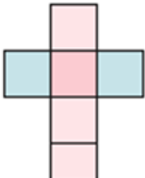
Pravilni poliedri

	Tetraedar	Oktaedar	Ikosaedar	Heksaedar	Dodekaedar
Platonovo tijelo					
Broj strana	4 grč. <i>tetra</i>	8 grč. <i>okta</i>	20 grč. <i>ikosa</i>	6 grč. <i>heksa</i>	12 grč. <i>dodeka</i>
Broj ivica	6	12	20	12	30
Broj tjemena/ rogljeva	4	6	12	8	20
Broj mno- gouglova sučeljenih u jednom roglju	3	4	5	3	3
Mreža					

Kocka

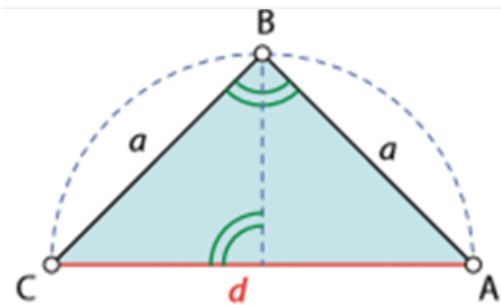
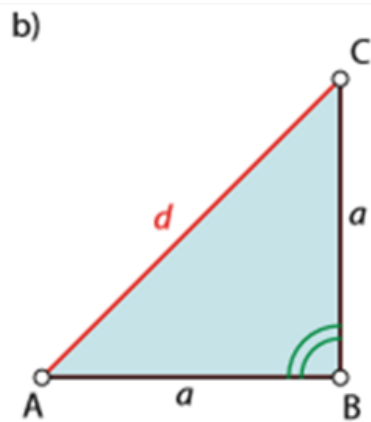
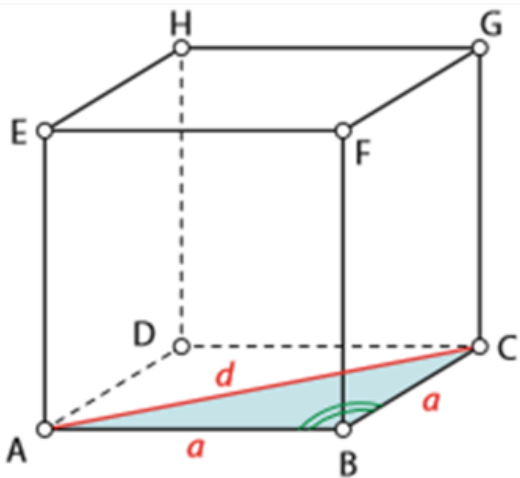
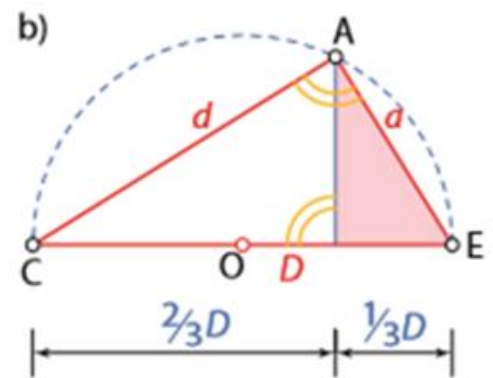
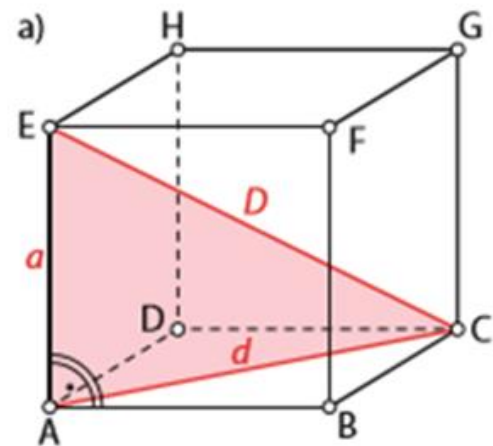
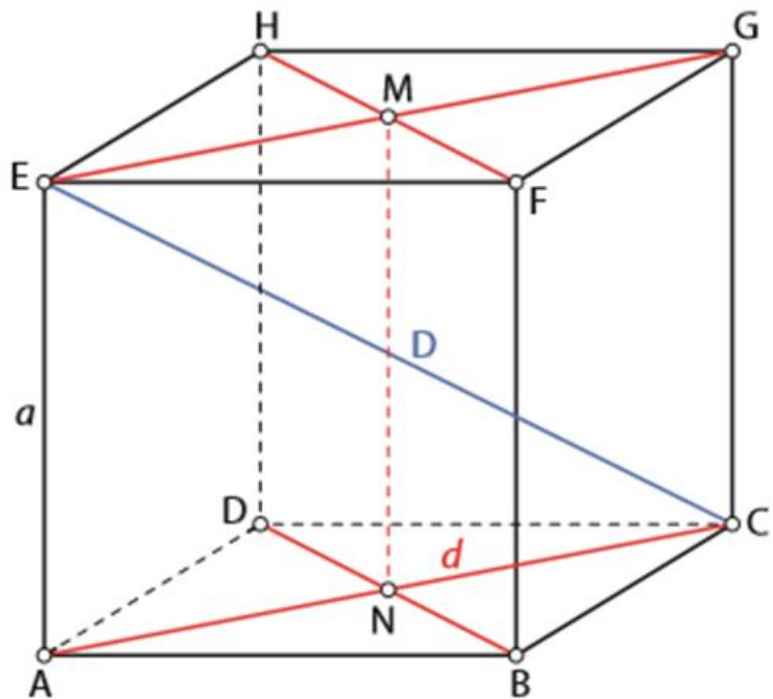

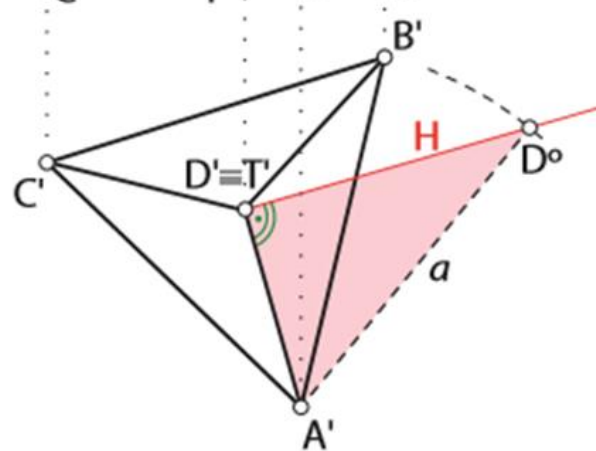
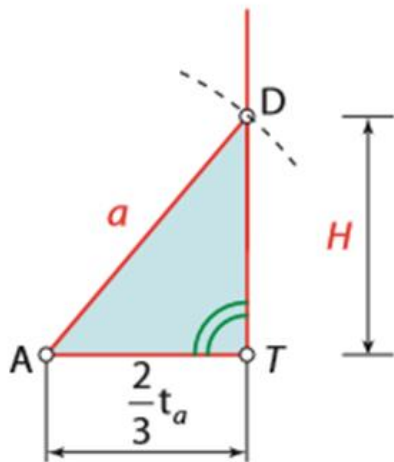
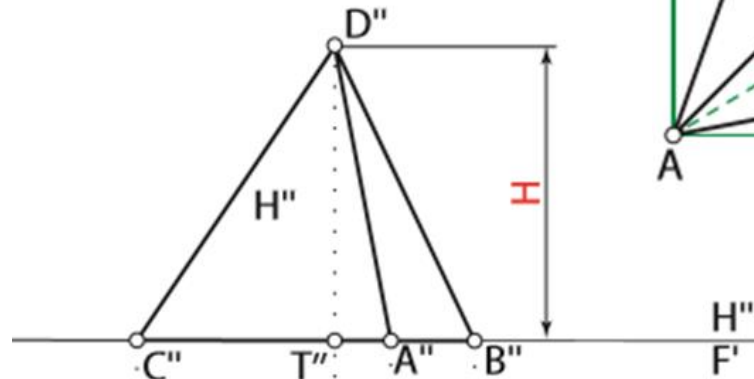
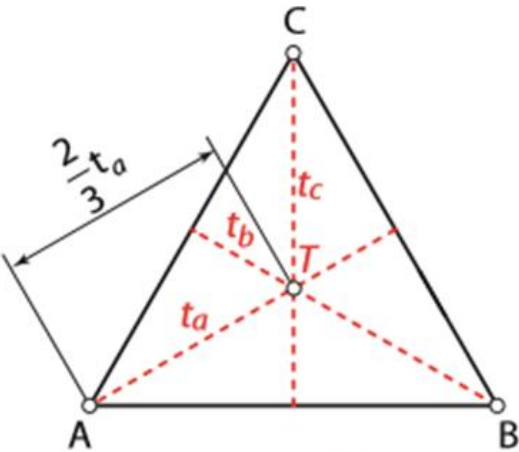
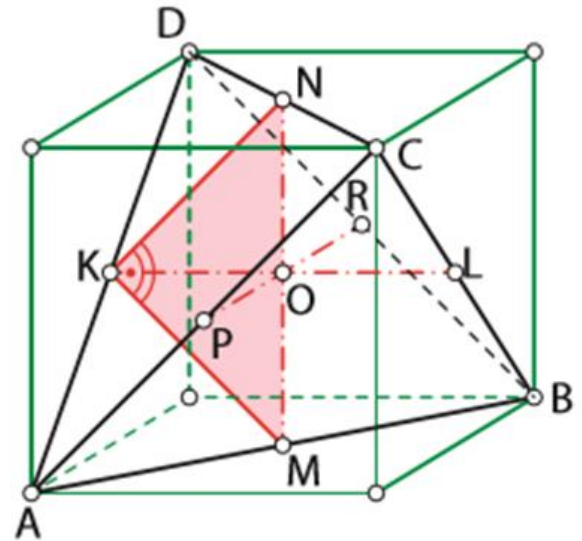
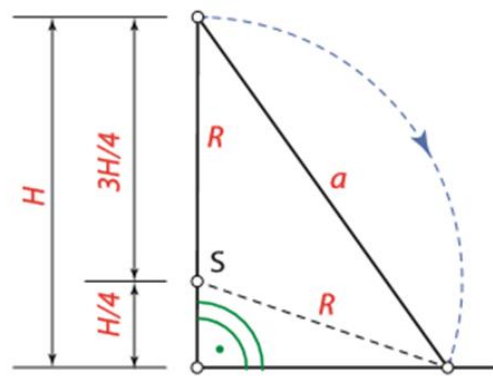
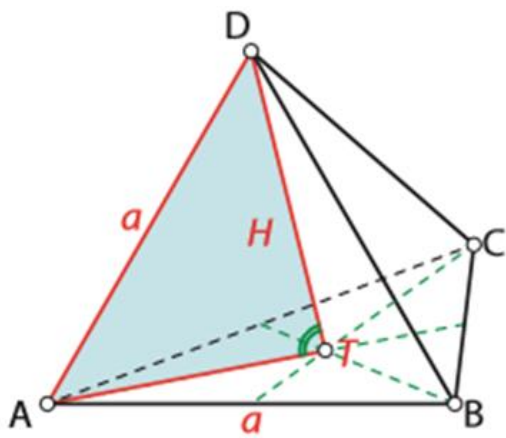

Tetraedar

Oktaedar

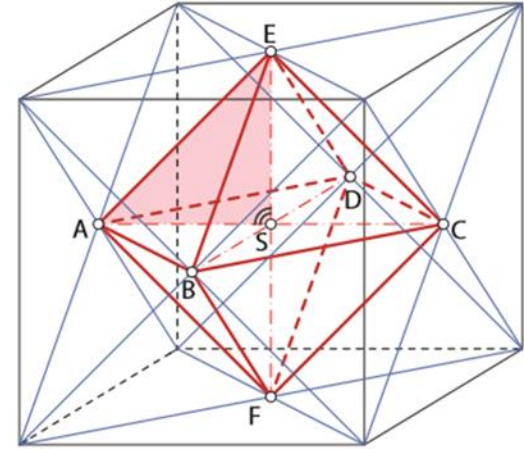
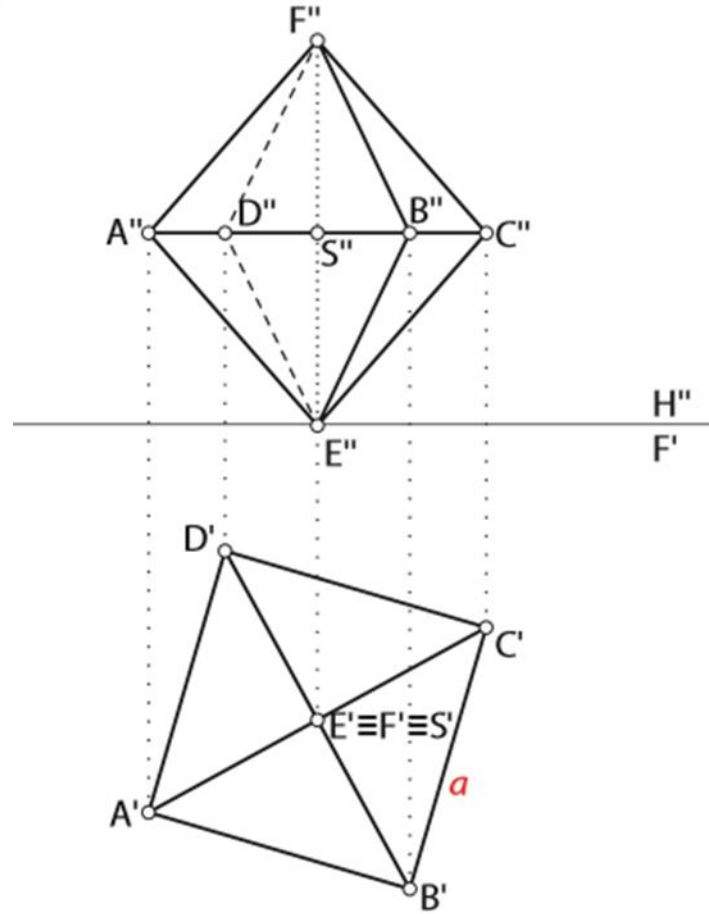
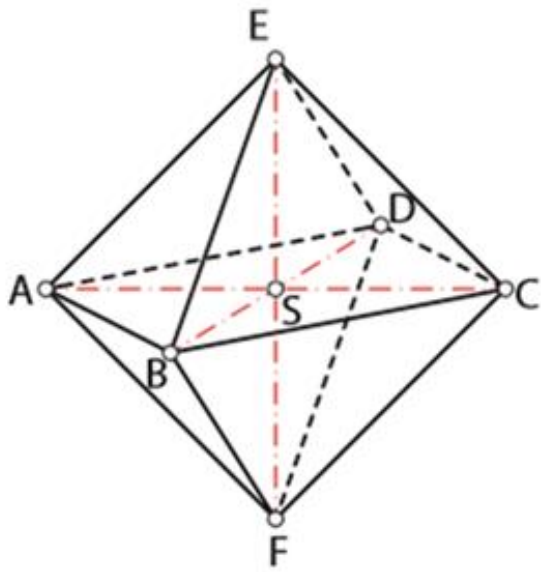

Great Stella

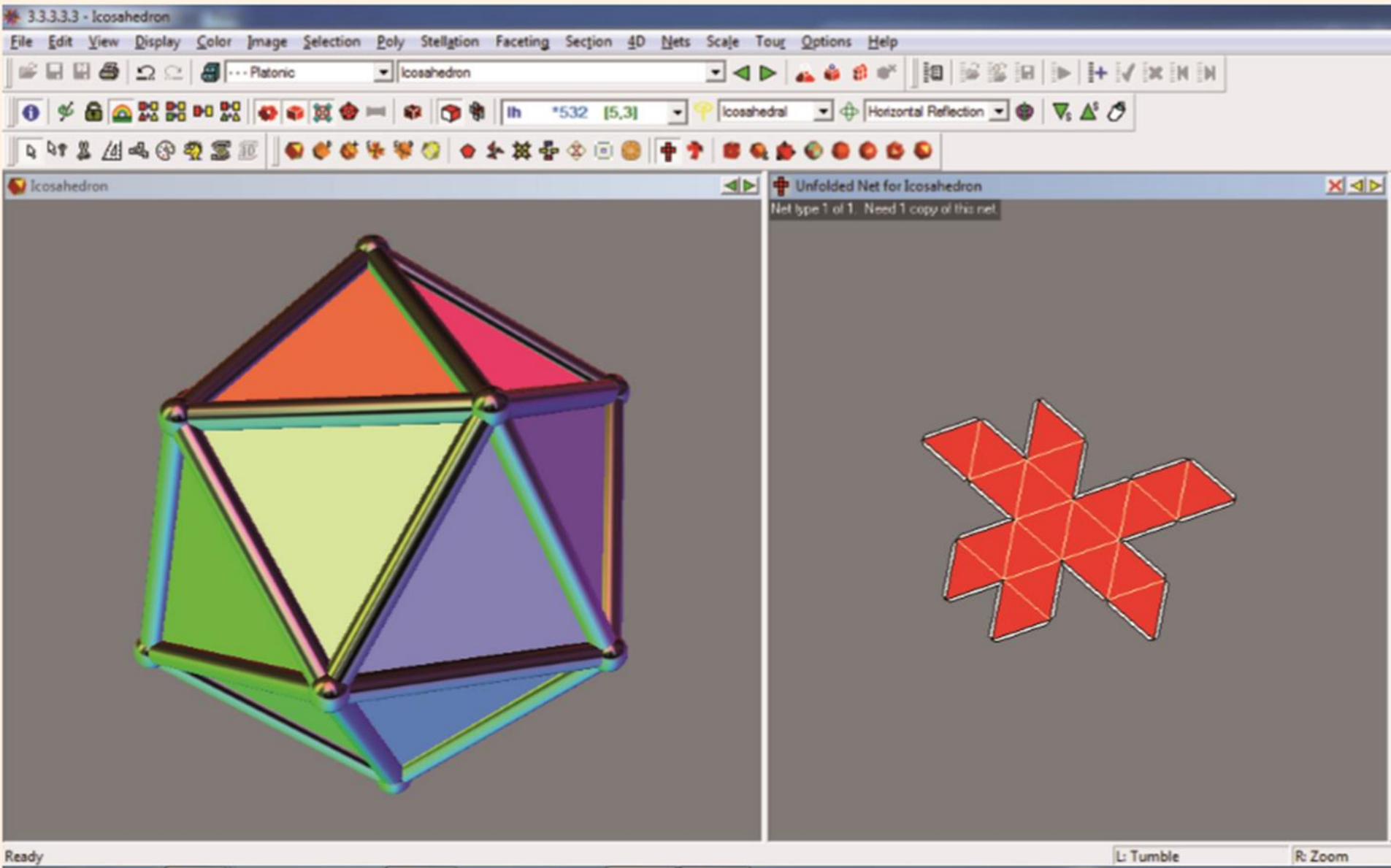

ovog trougla je prava velicin

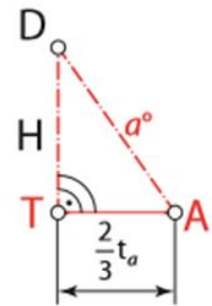
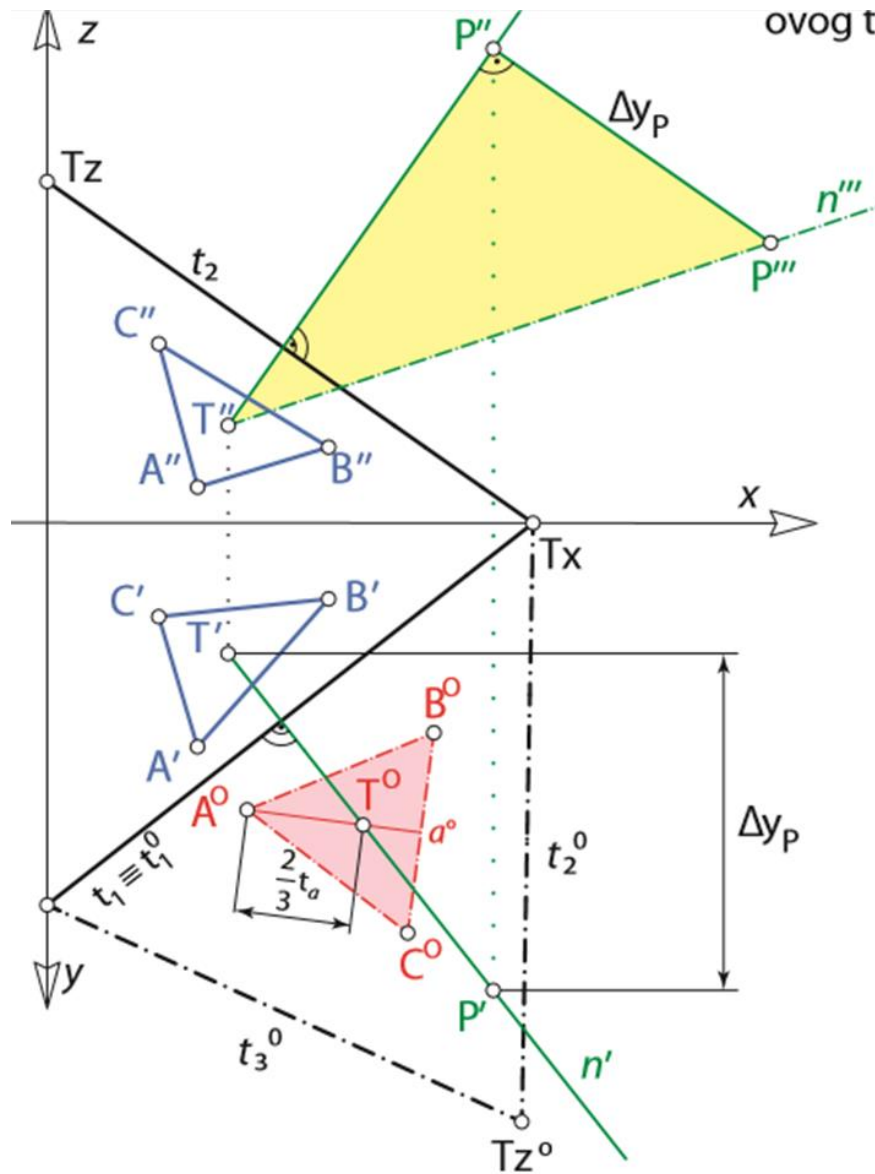
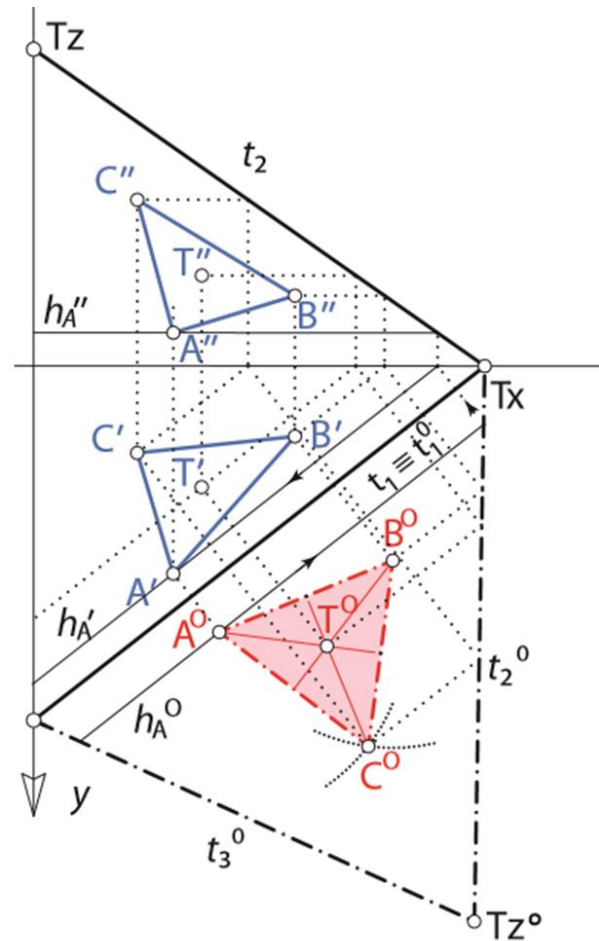

Konstrukcija tetraedra čija baza ABC pripada kosoj ravni

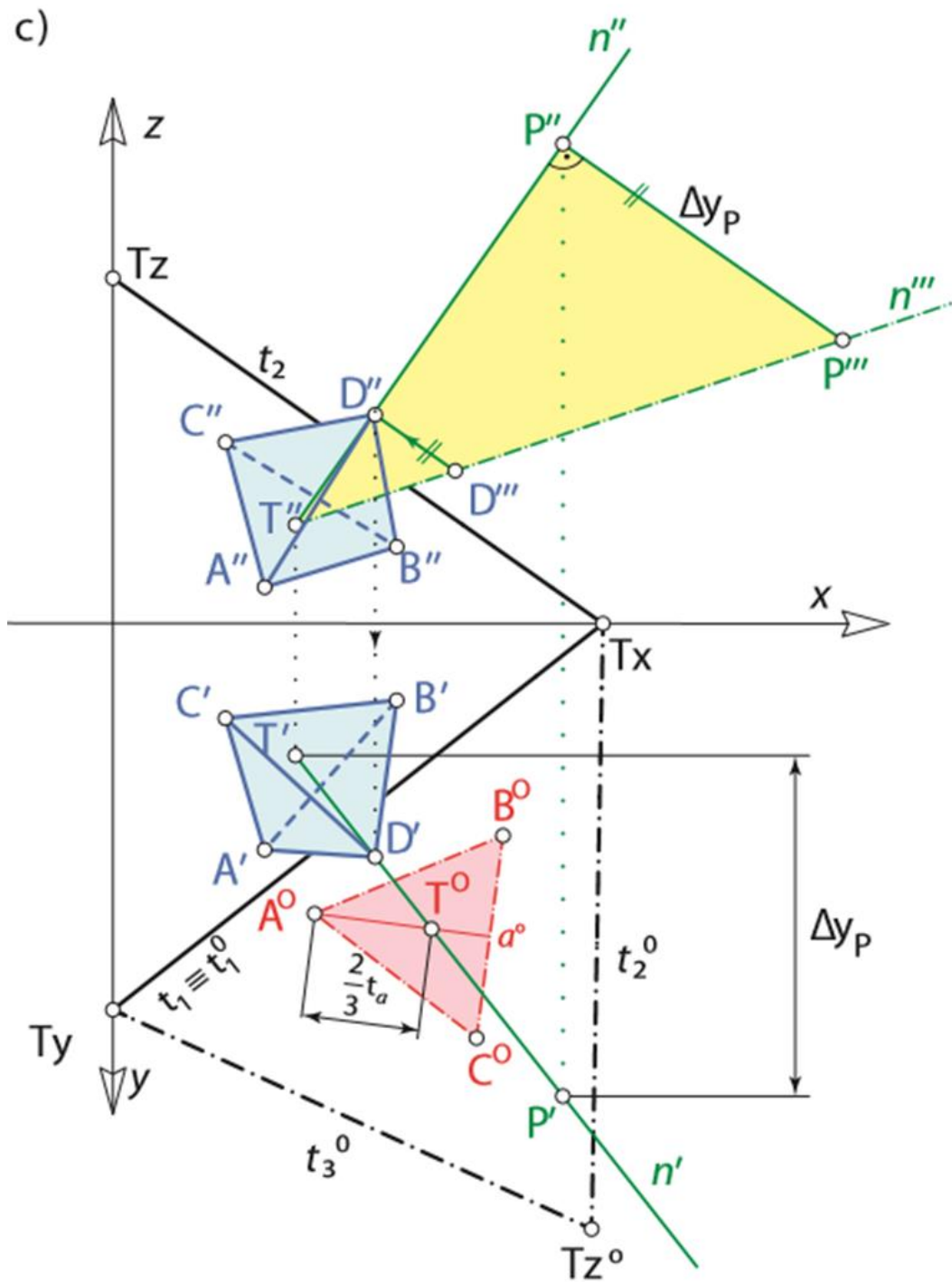

Krovovi



Krovovi

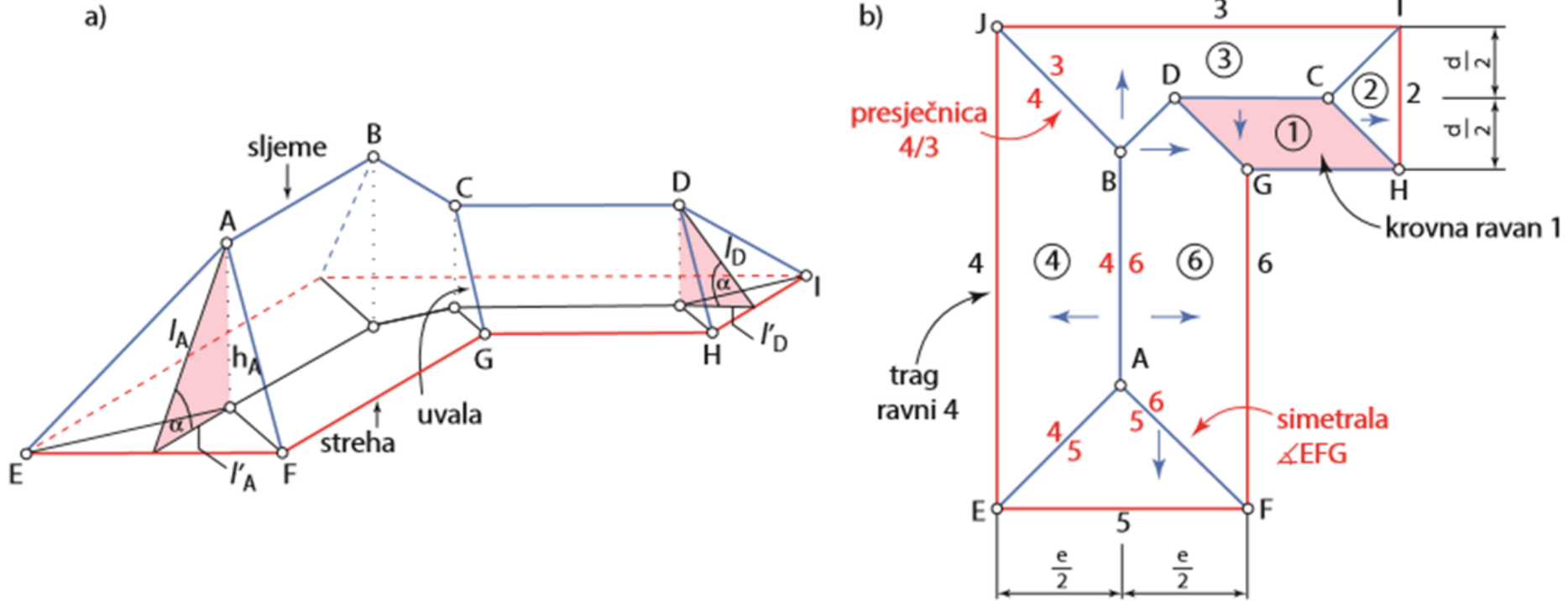

Elementi jednostavnih i složenih krovova

Vrste jednostavnih krovova

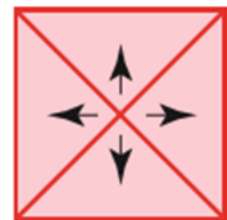
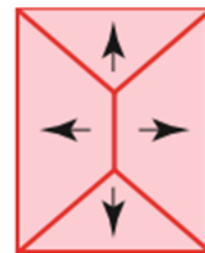
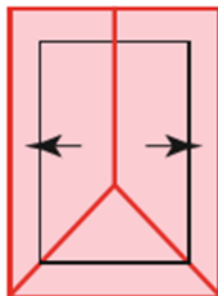
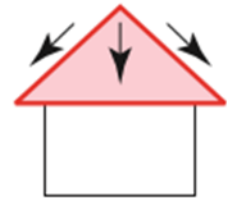
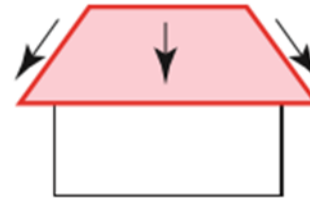
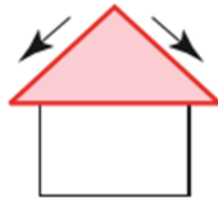
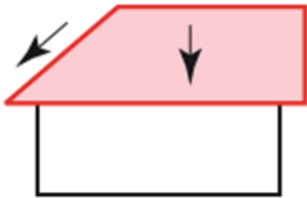
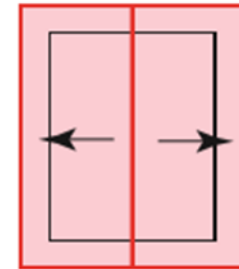
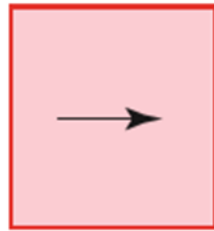
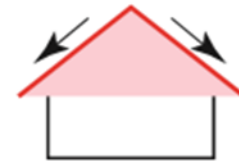
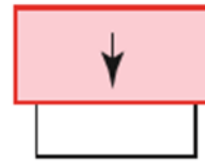
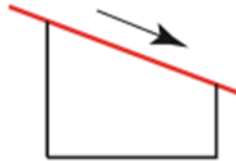

Rješavanje složenih krovova

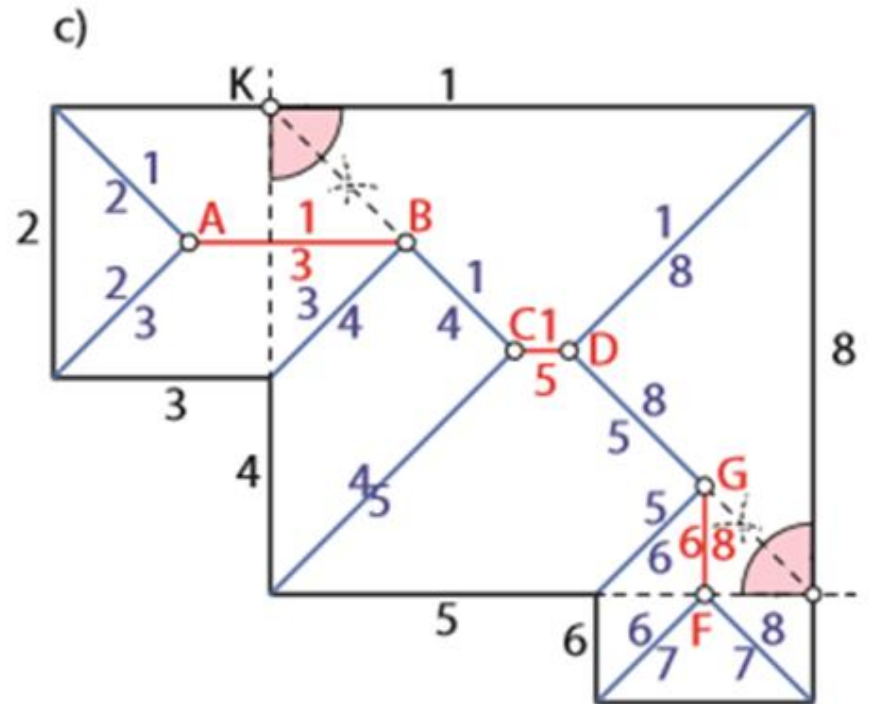
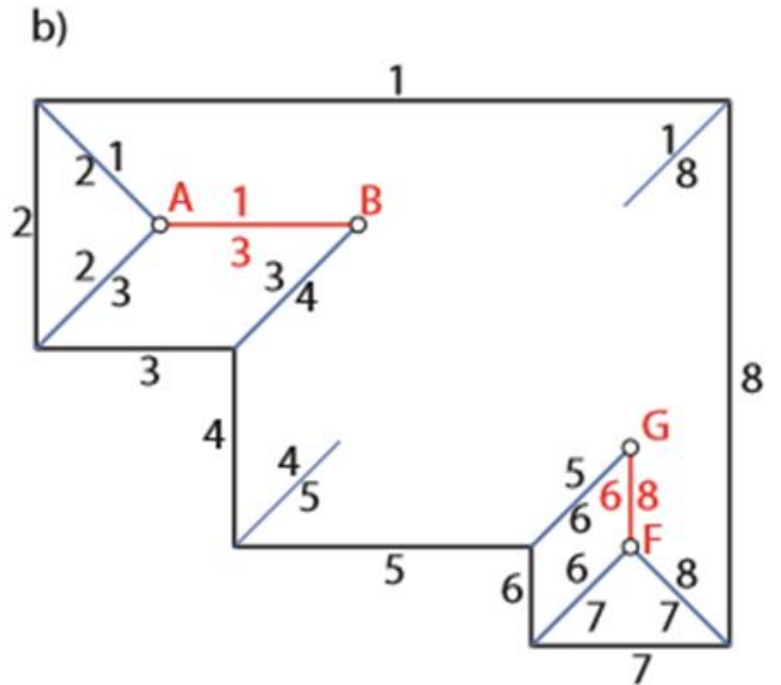
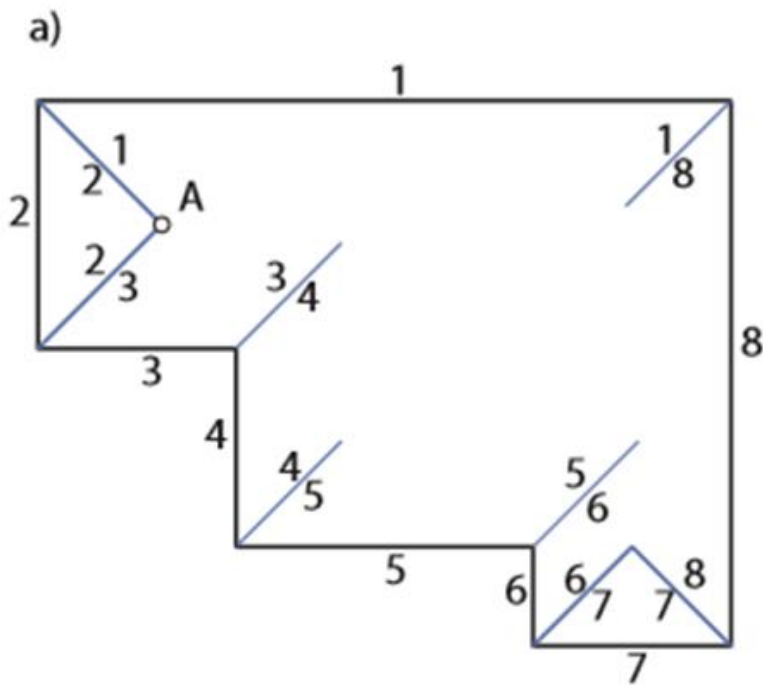

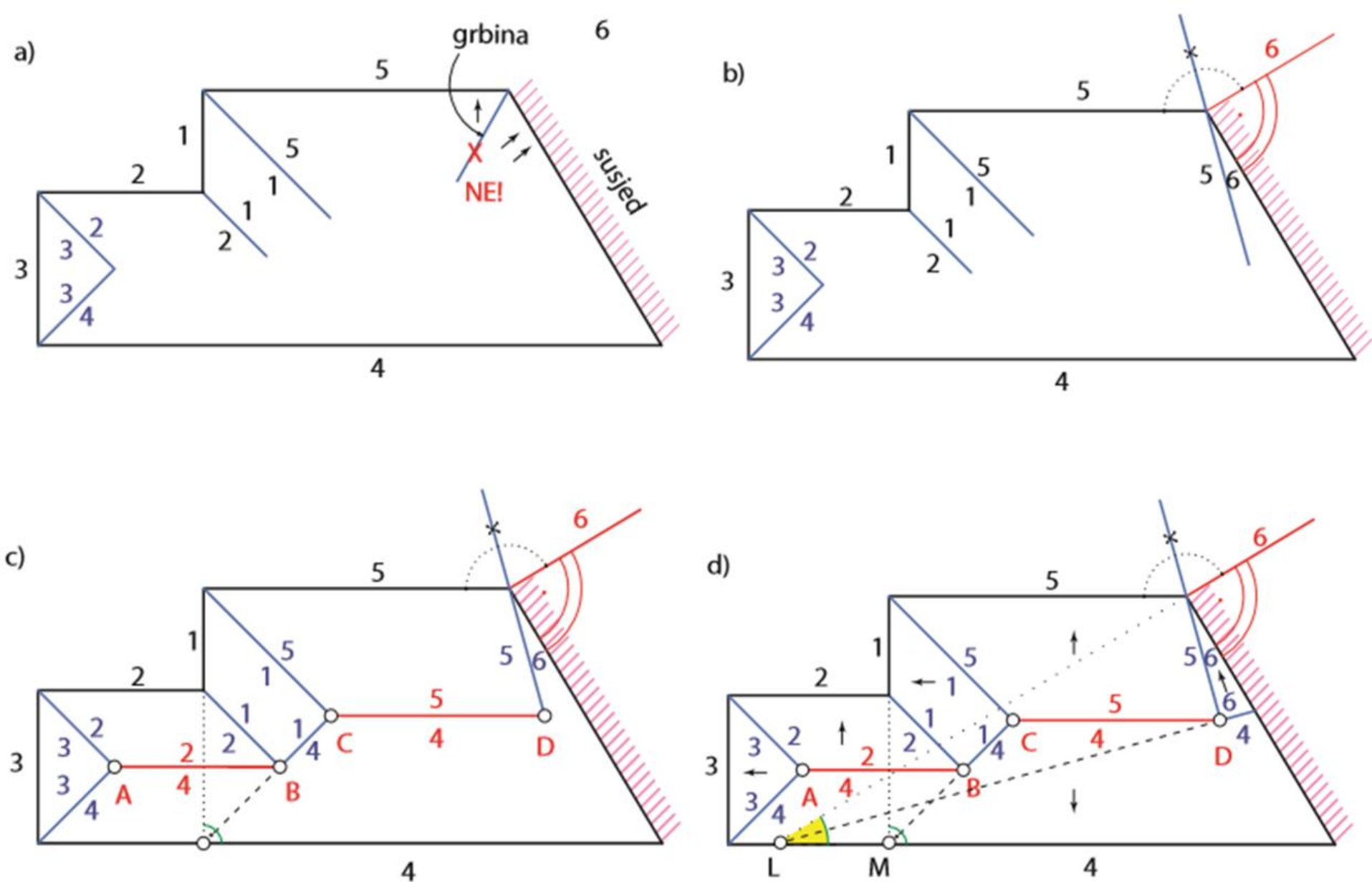

Rješavanje složenih krovova

Rješavanje složenih krovova

a)

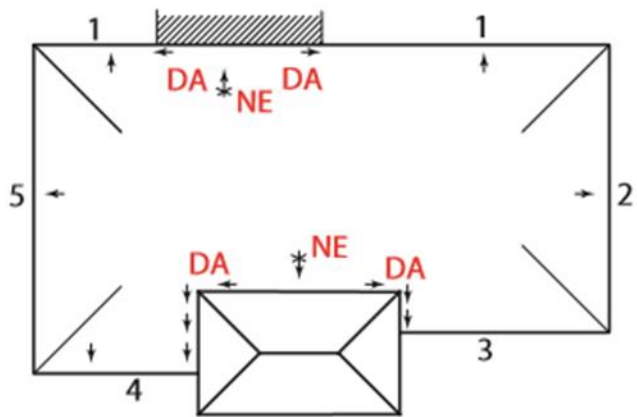

b)

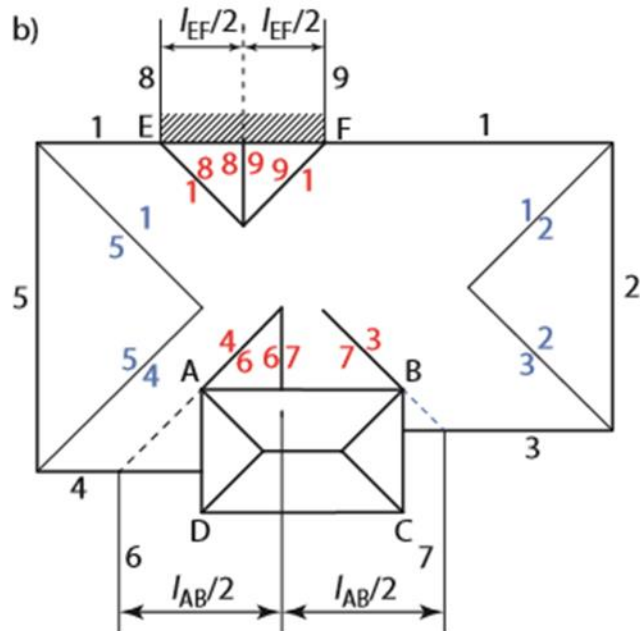

c)

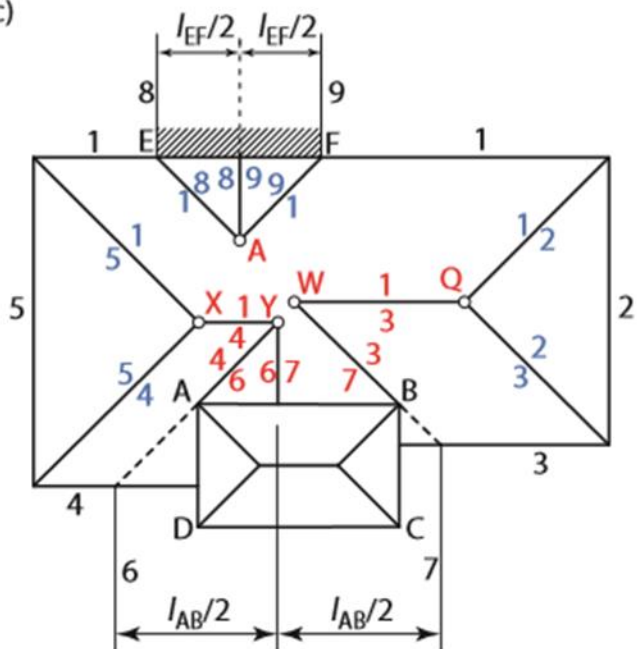

d)

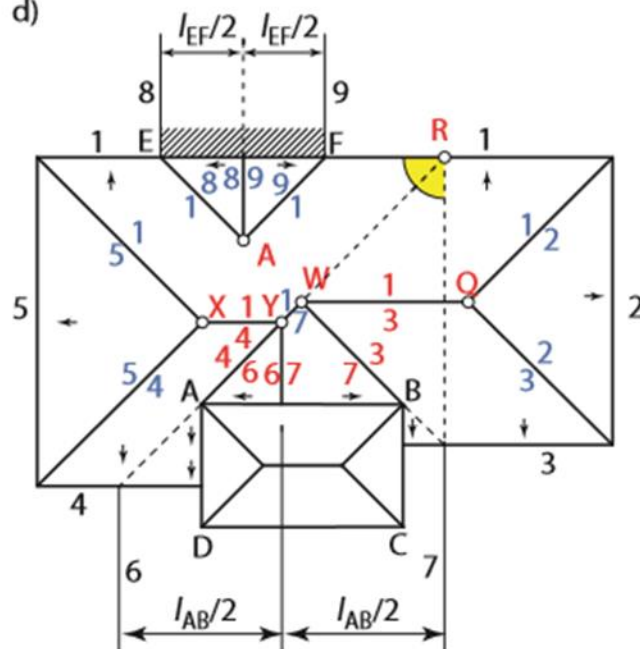

Rješavanje složenih krovova

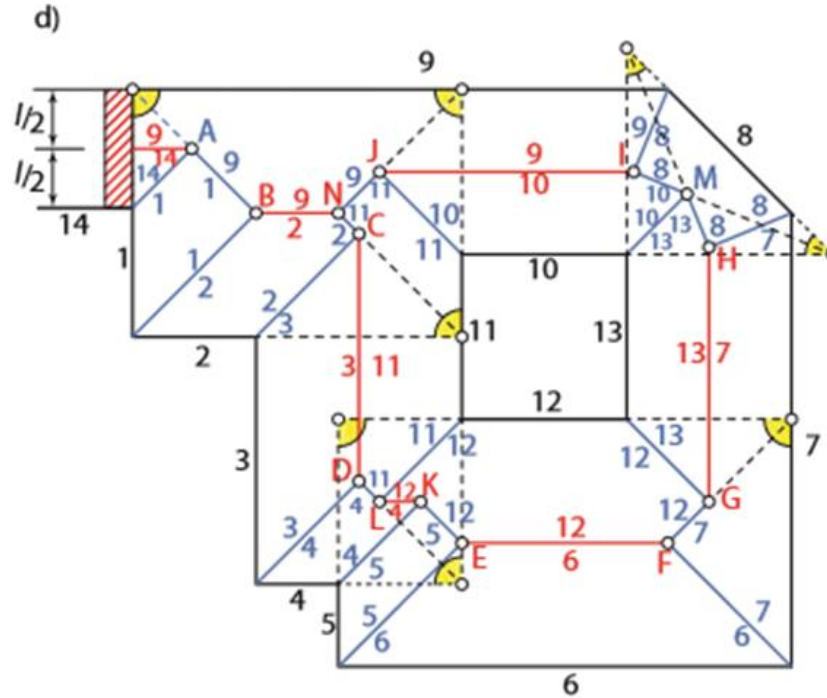
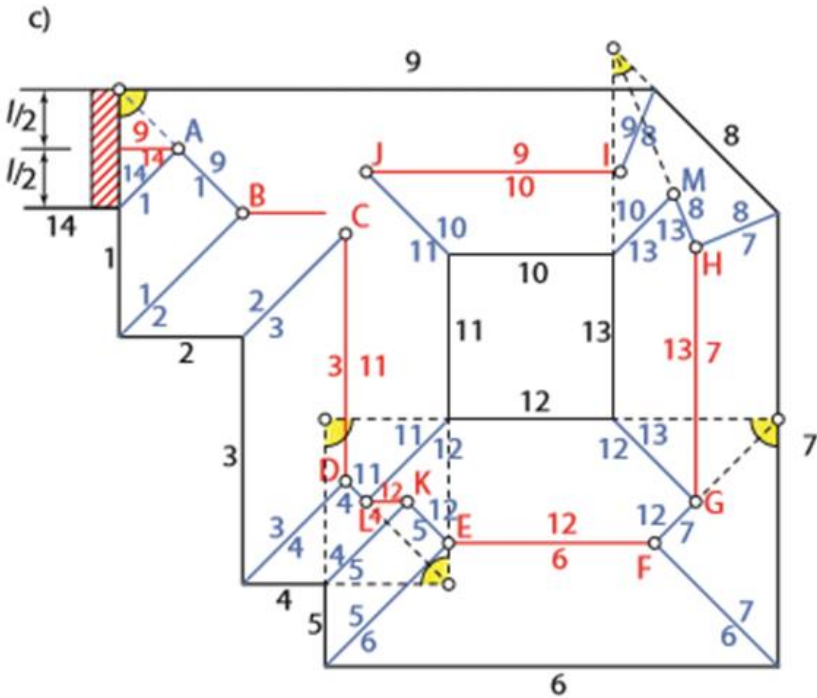
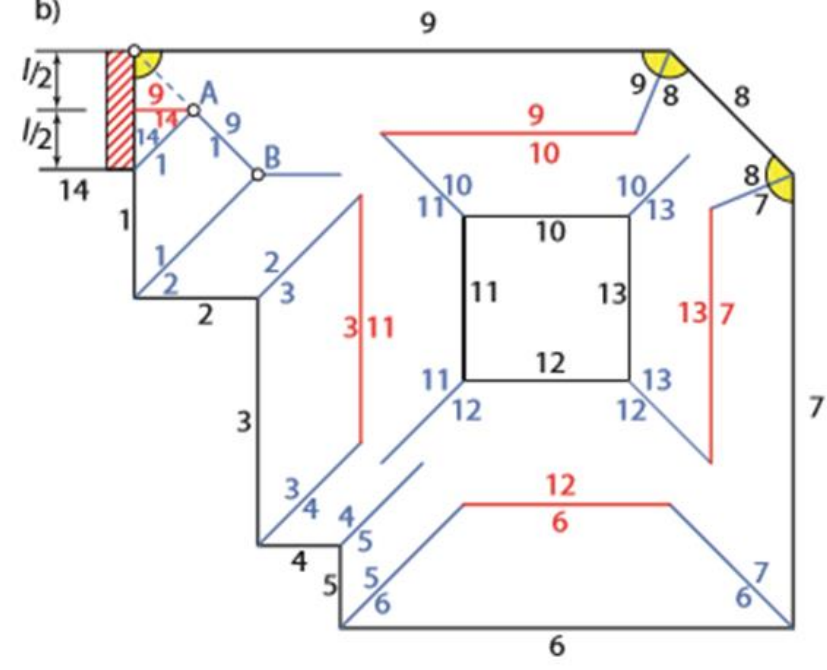
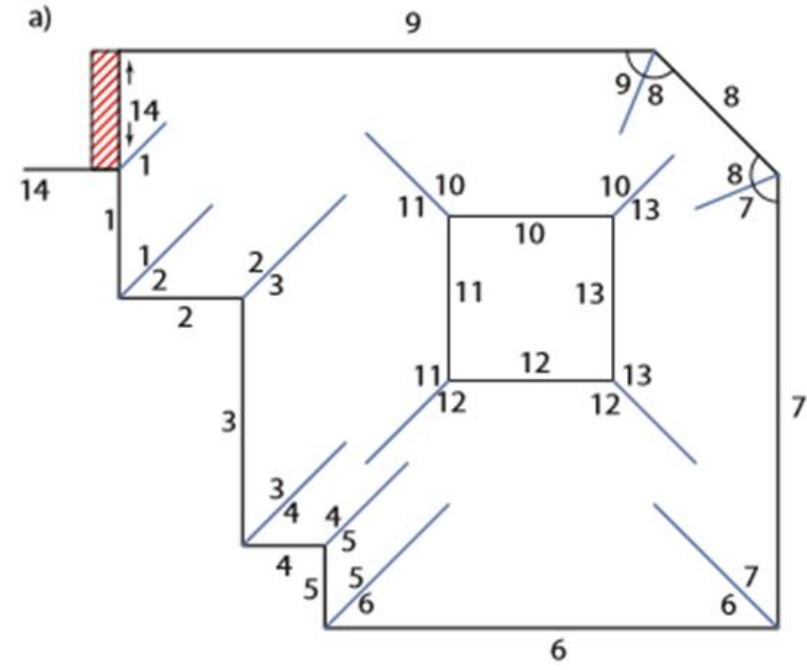





TREĆA PROJEKCIJA TRIEDRA

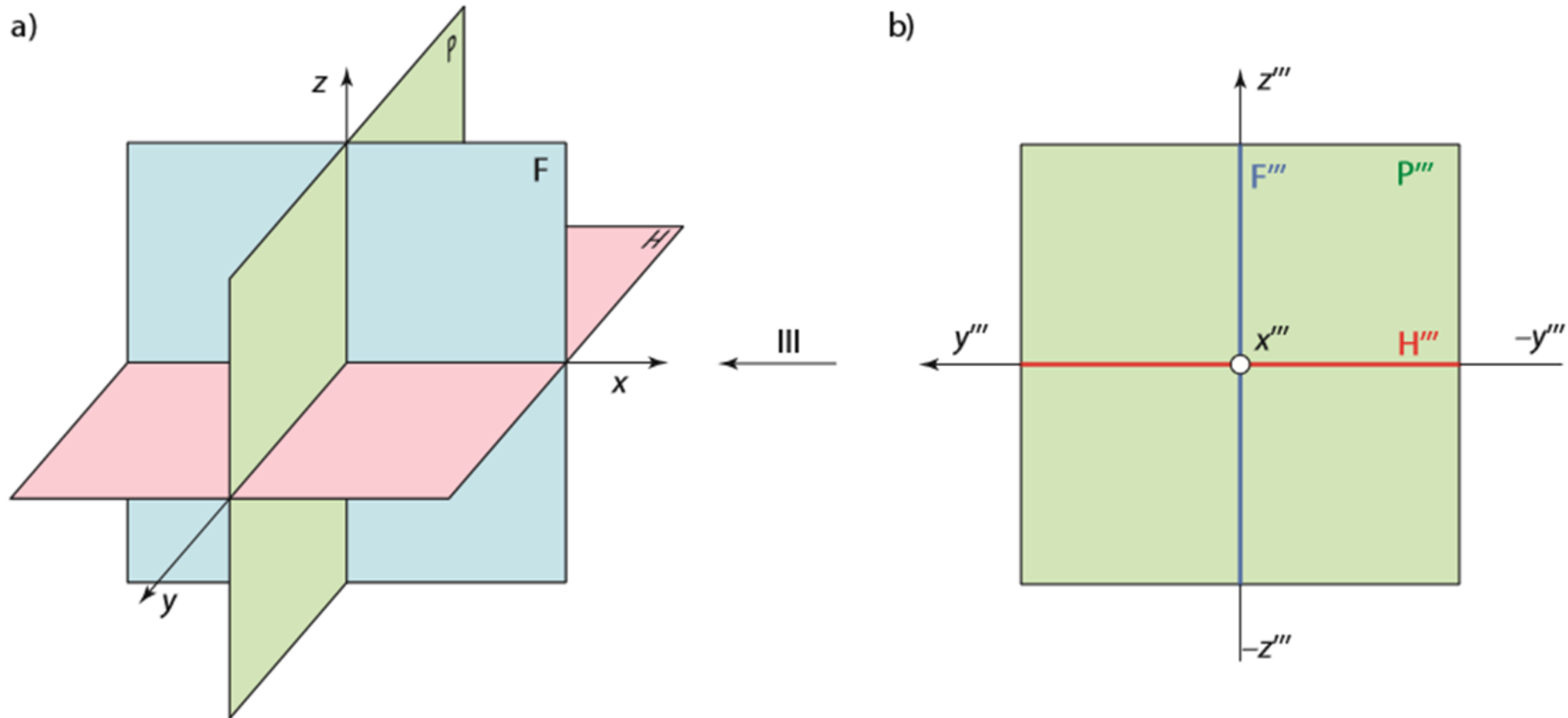

TRIEDAR U TRI ORTOGONALNE PROJEKCIJE

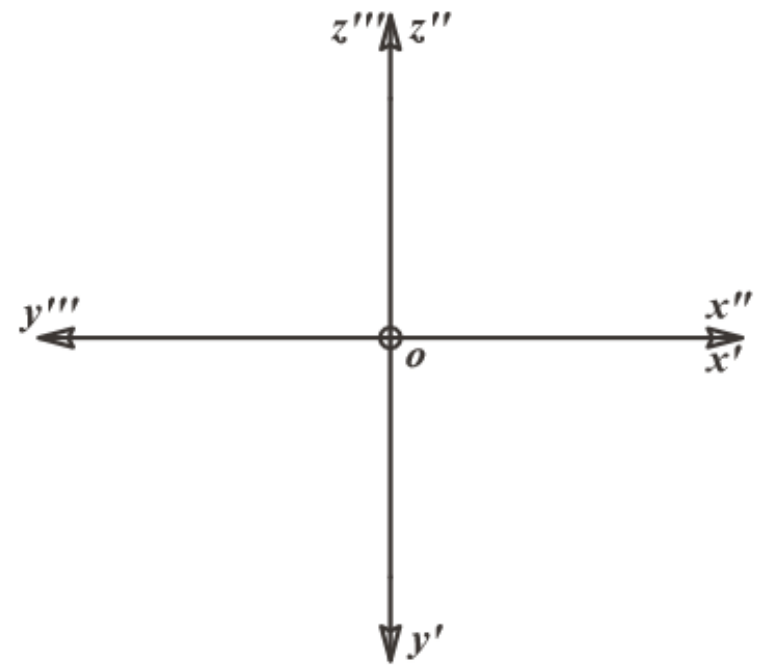
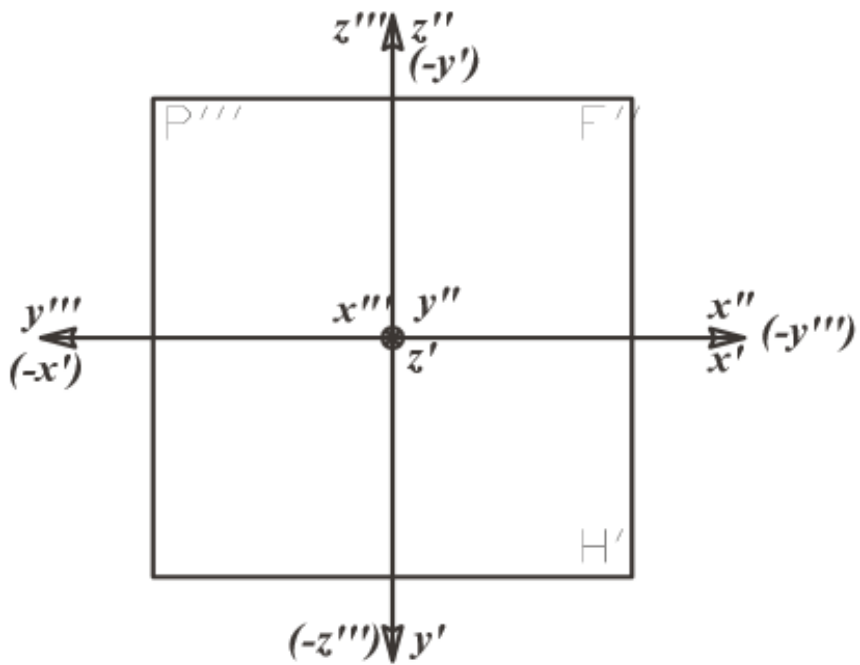

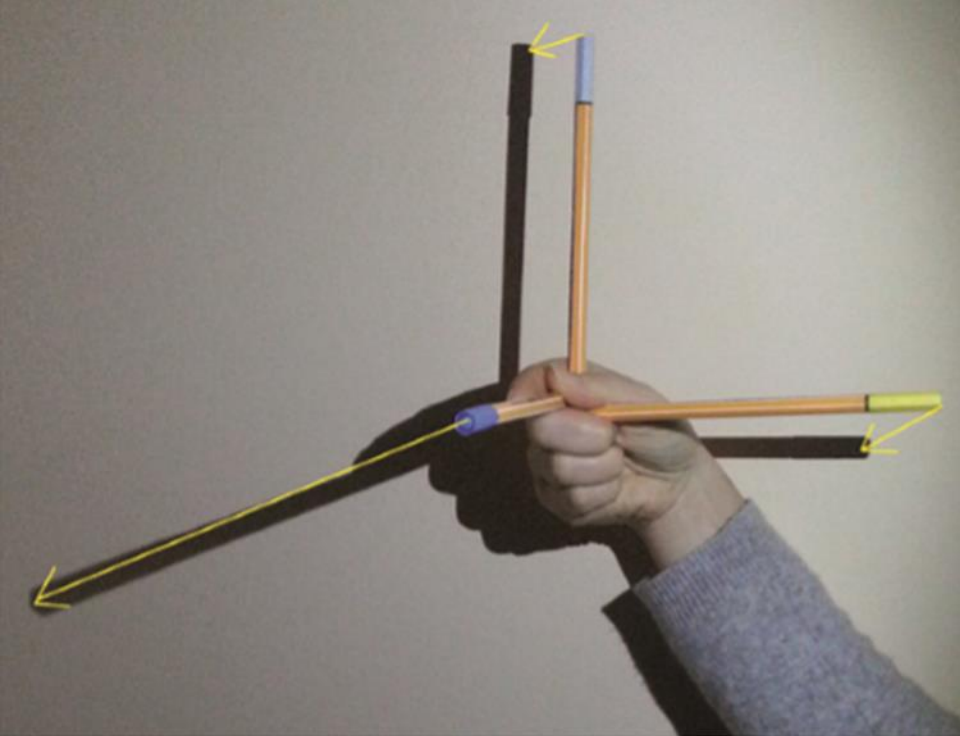

a)

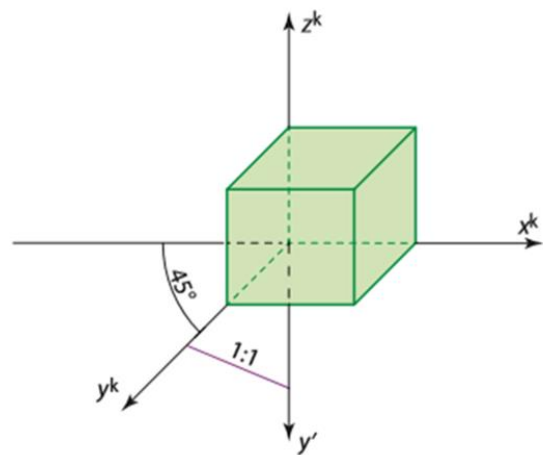
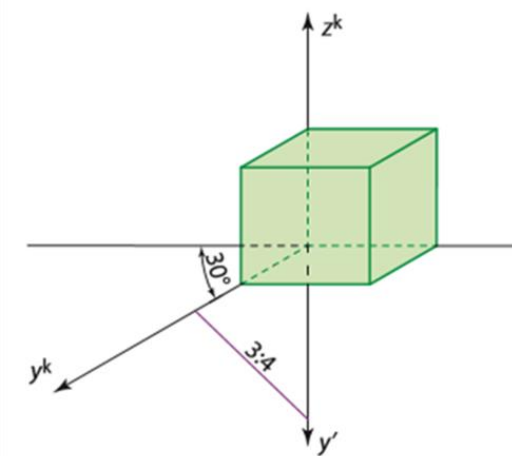
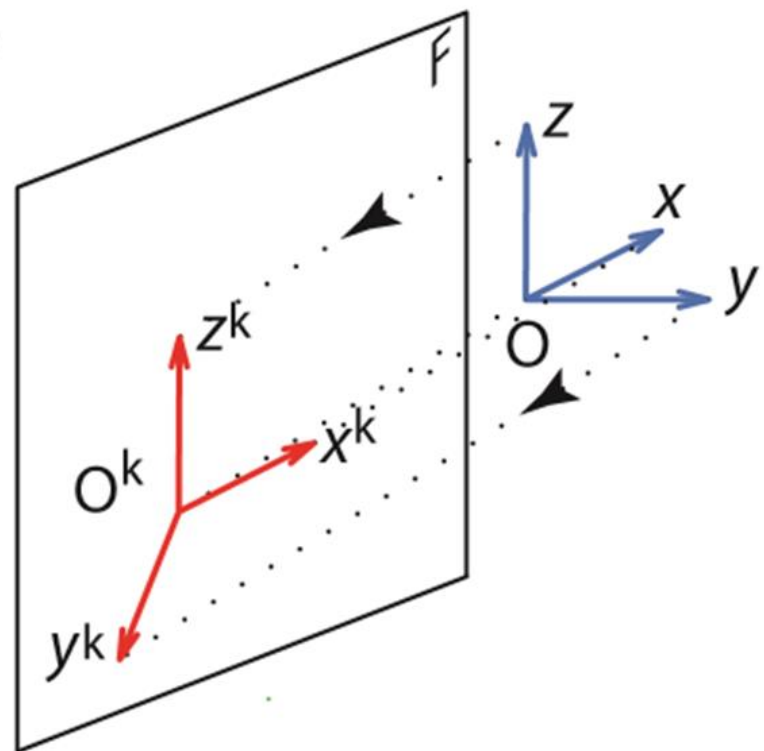

b)

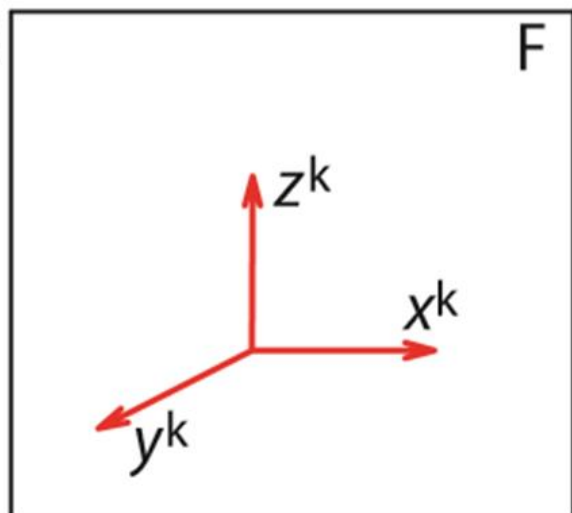

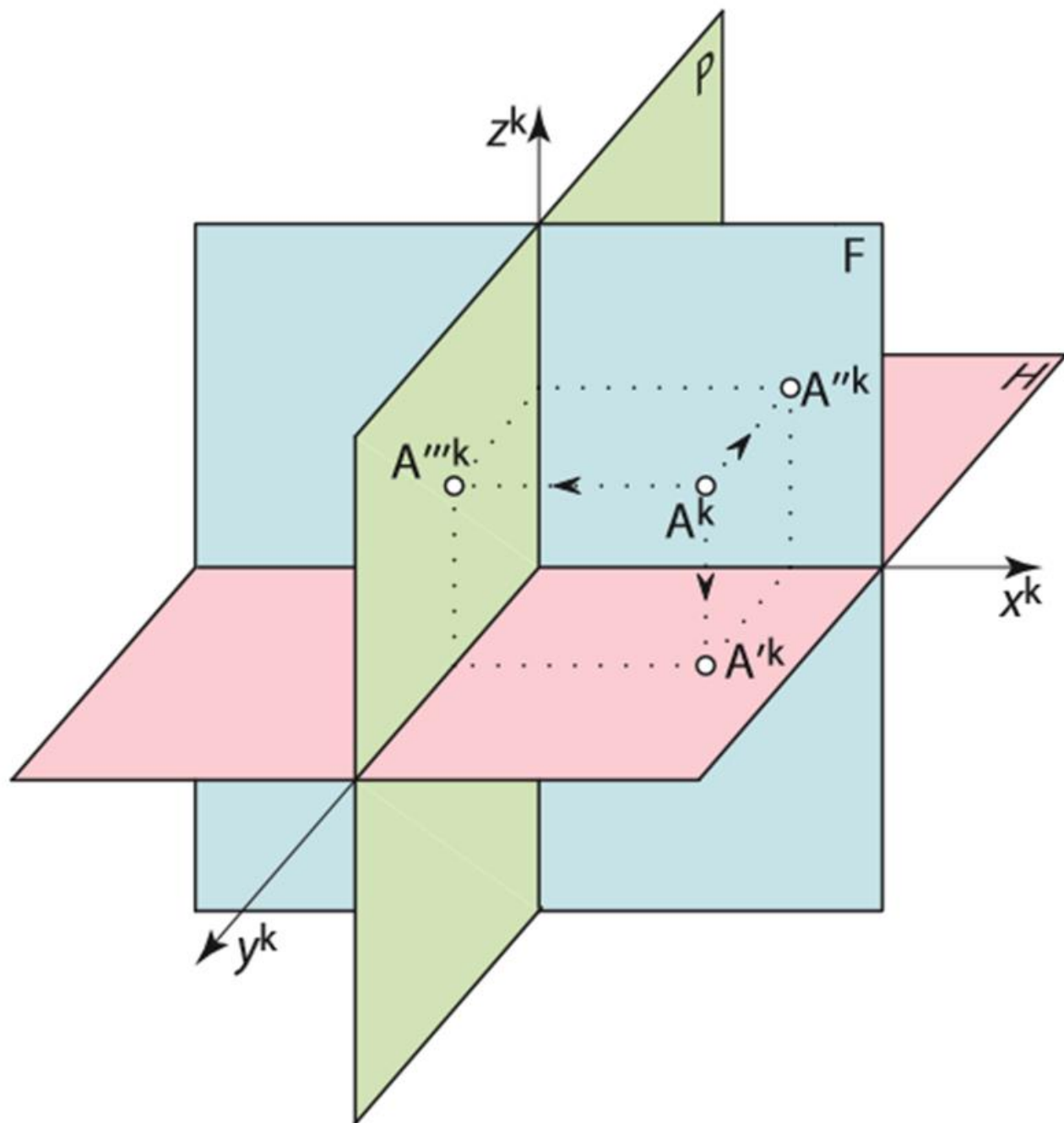

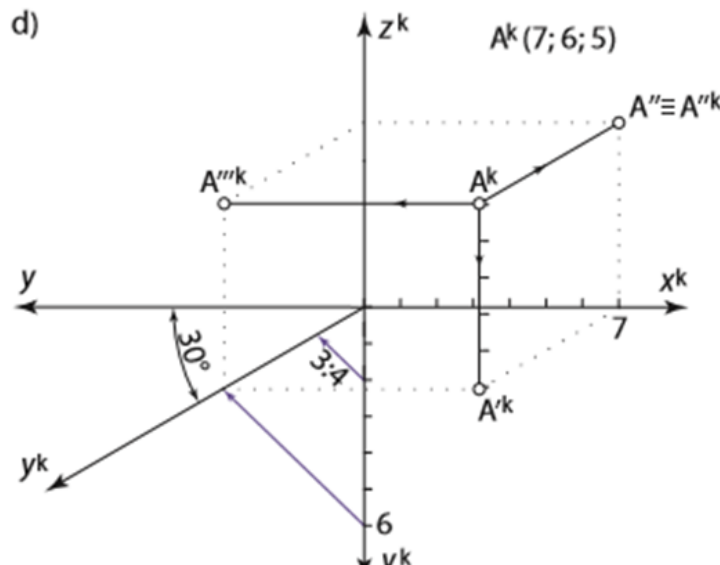
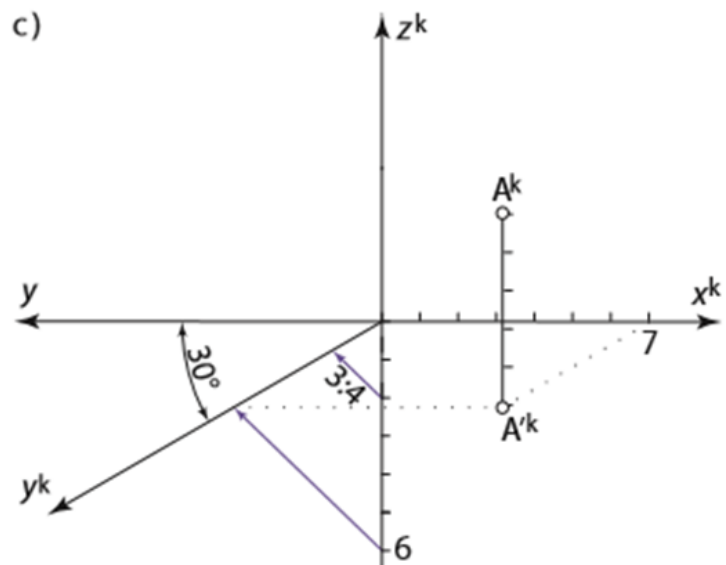
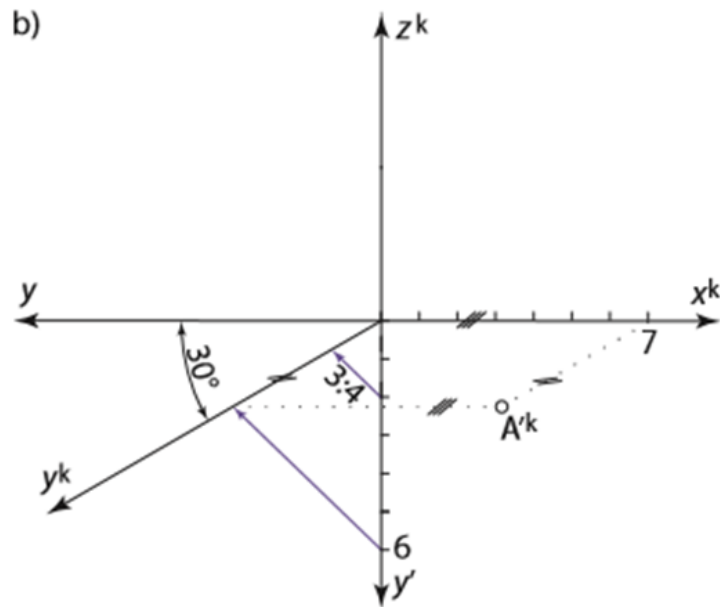
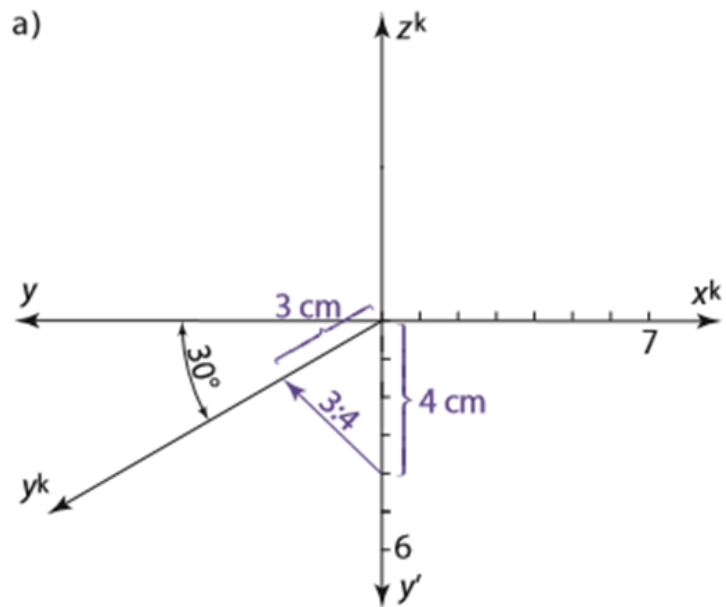

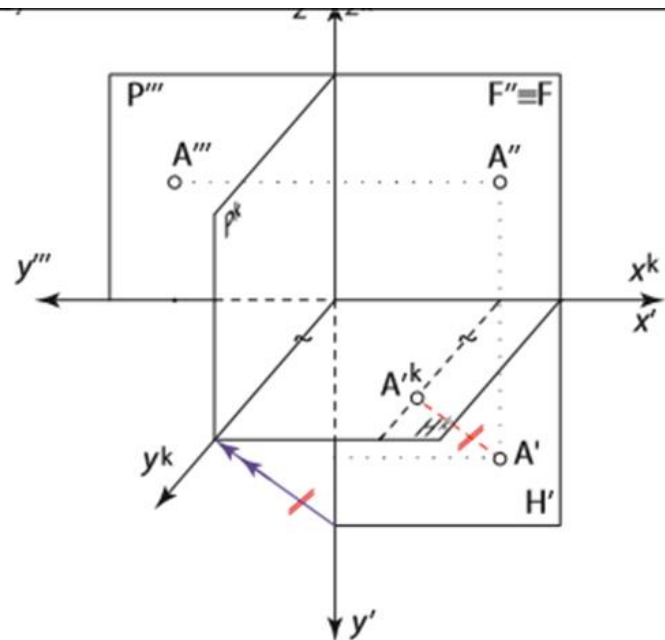
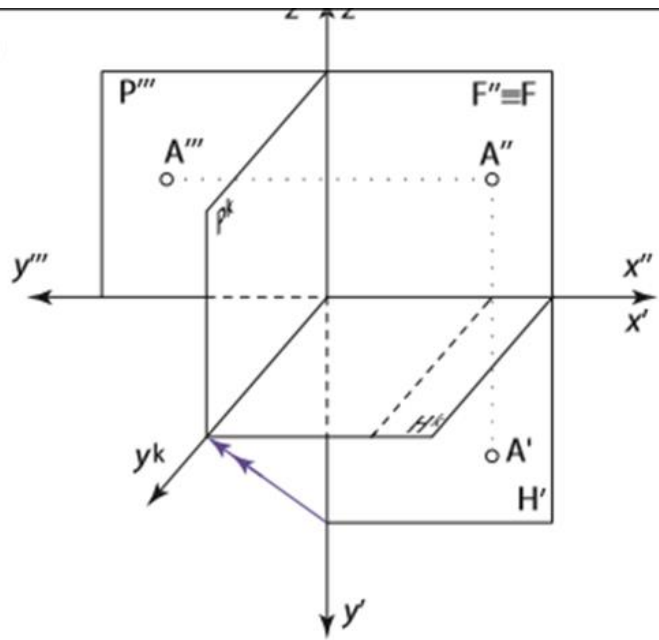

c)

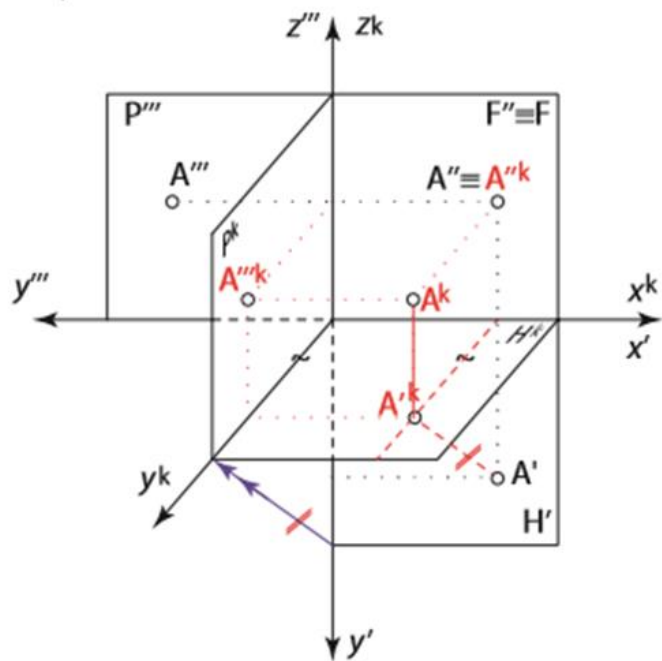

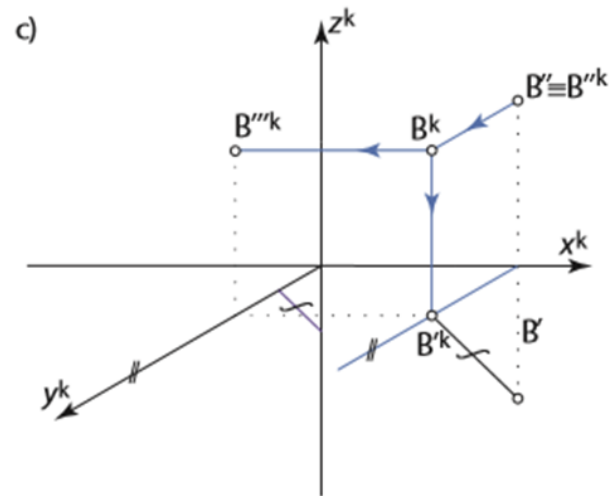
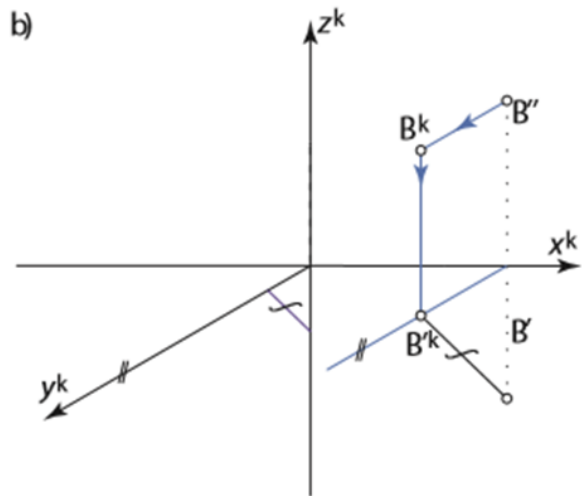
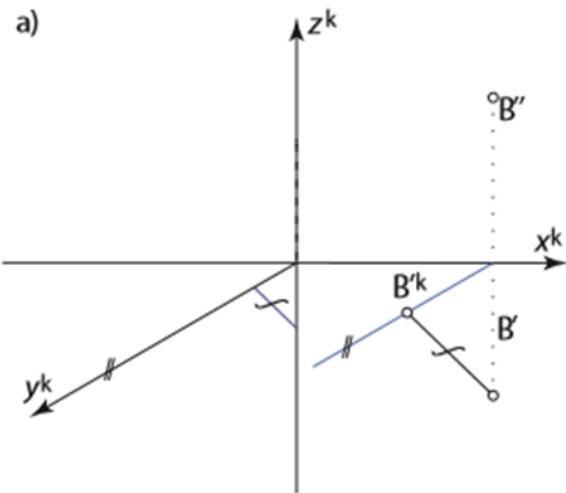

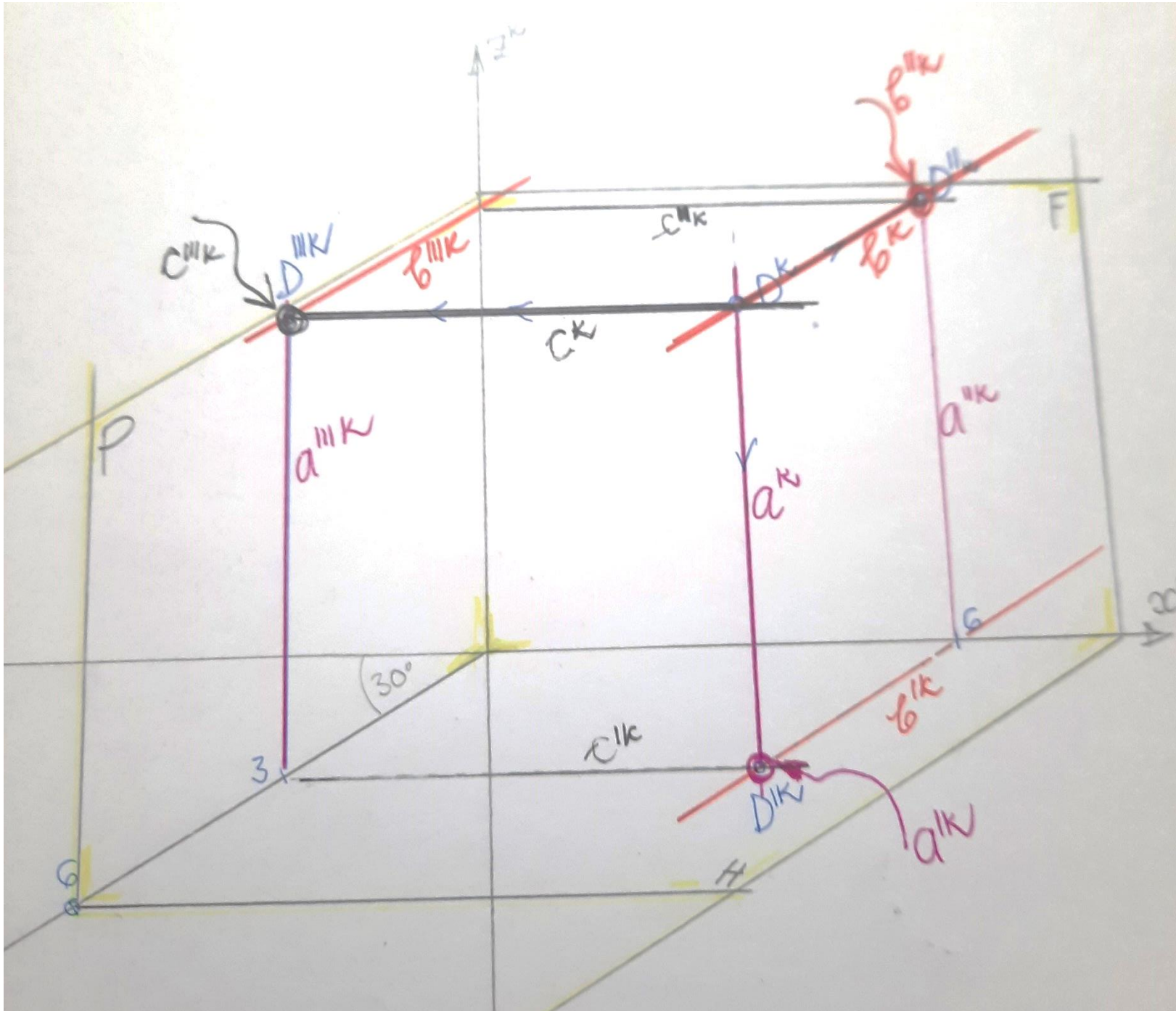

Ako triedar projiciramo samo na jednu ravan, ali zracima ortogonalnim na tu ravan, dobijamo **ortogonalne aksonometrije**: izometriju, dimetriju i trimetriju (slika C1.9a). Od položaja triedra prema projekcijskoj ravni zavisice uglovi između osa x , y i z u aksonometrijskom prikazu:

- izometrija – svi uglovi jednaki (120°),
- dimetrija – uglovi yOz i xOz jednaki,
- trimetrija – sva tri ugla različita.

Vrste **kose aksonometrije** prikazane su na slici C1.9b. To su frontalna kosa projekcija, koju proučavamo i kod koje ugao xOz ostaje prav, i planimetrijska, kod koje ugao xOy ostaje prav.

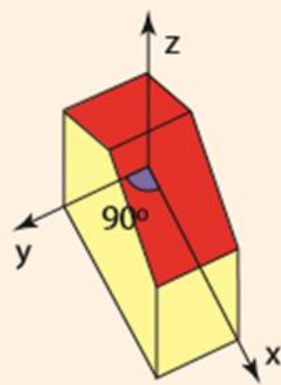
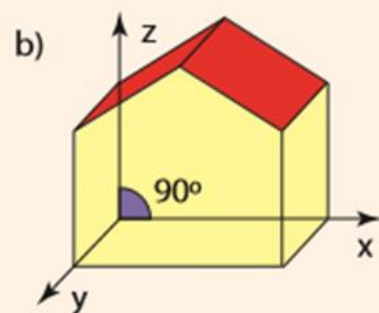
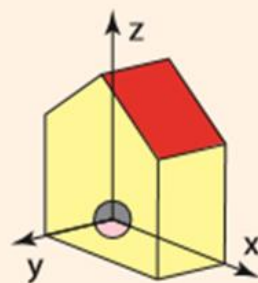
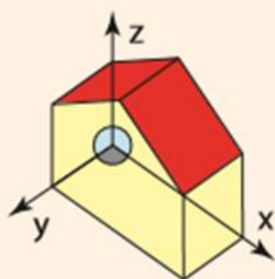
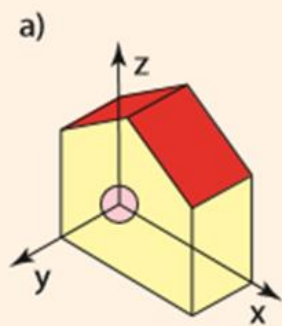

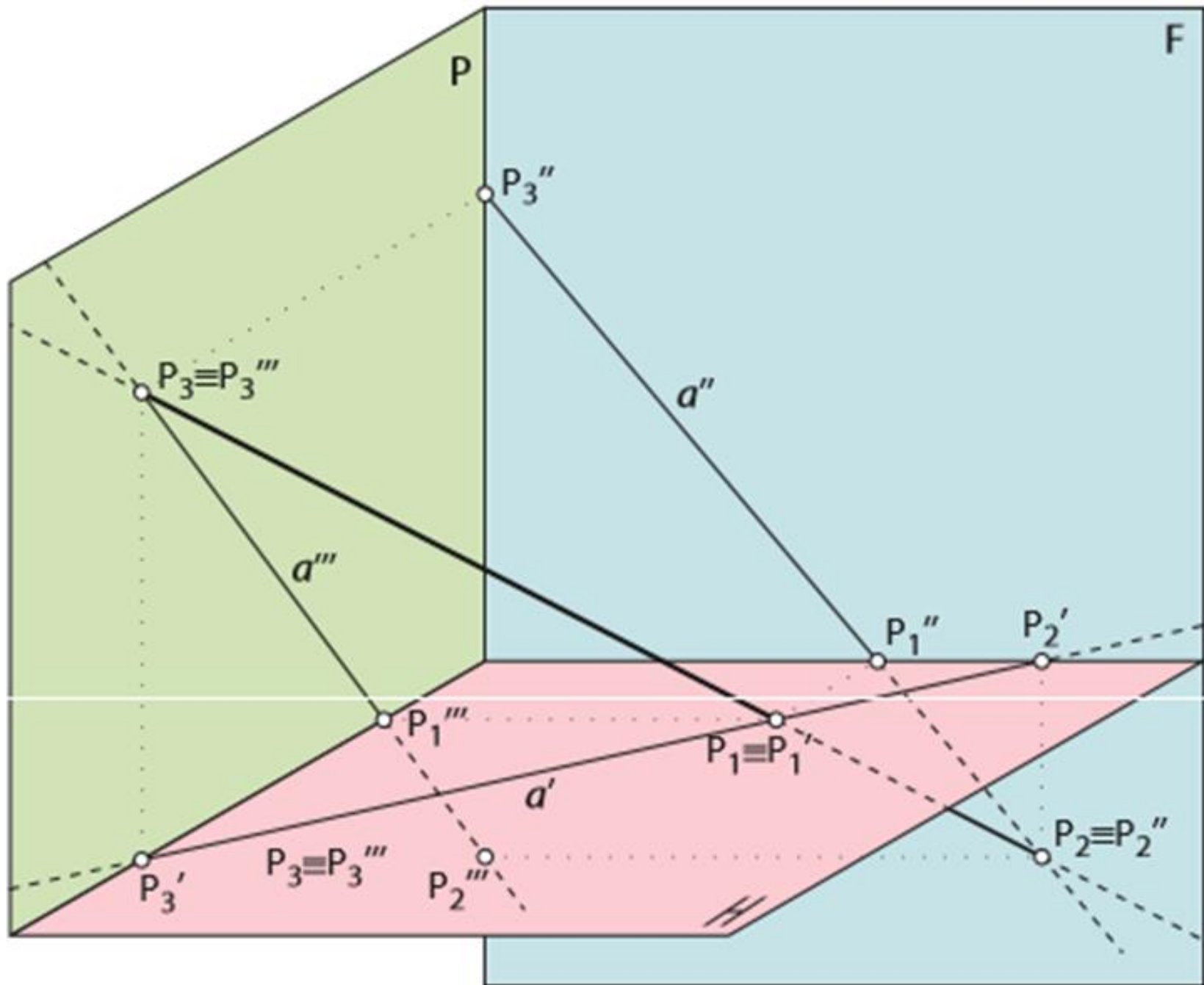

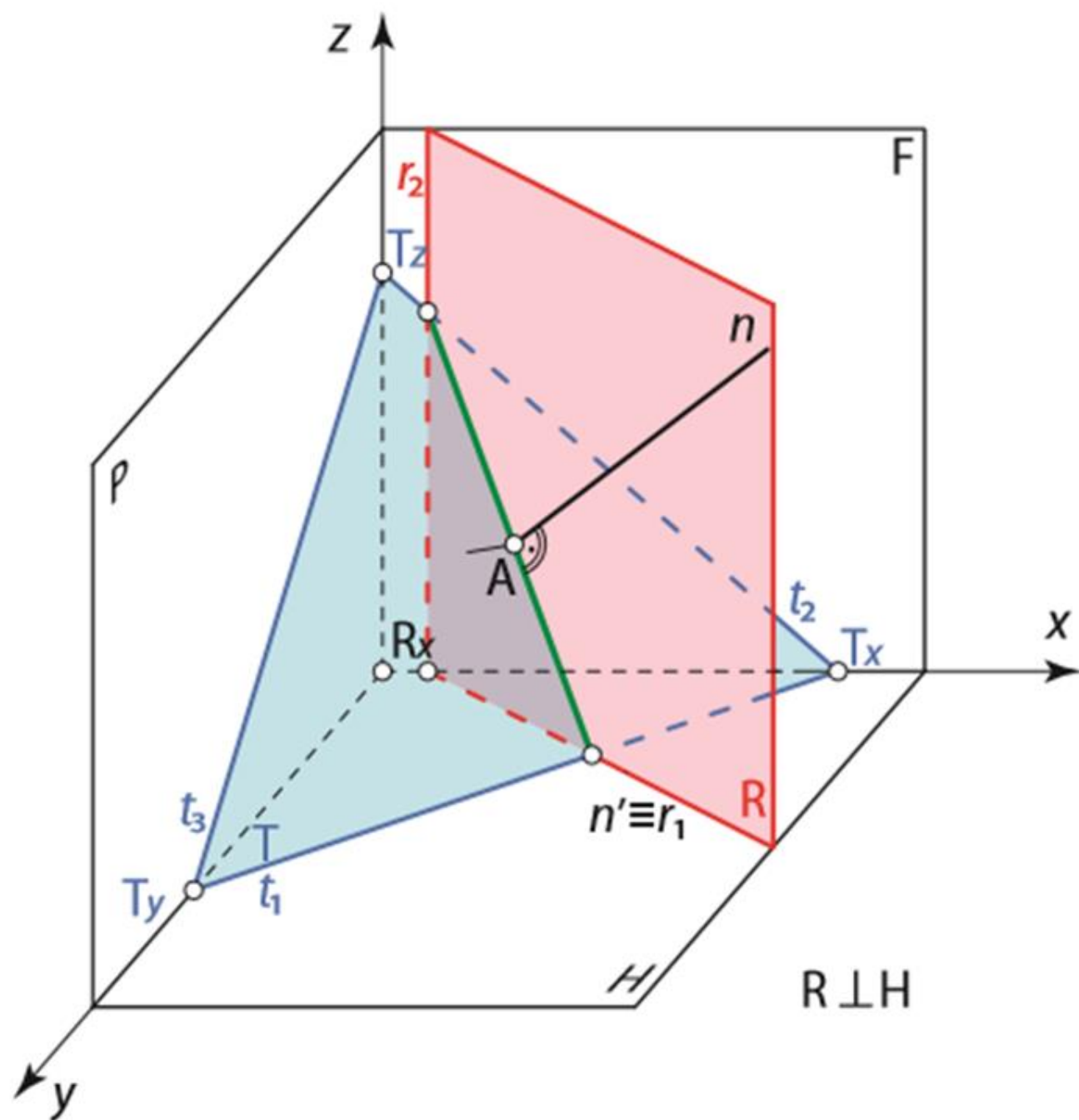

a)

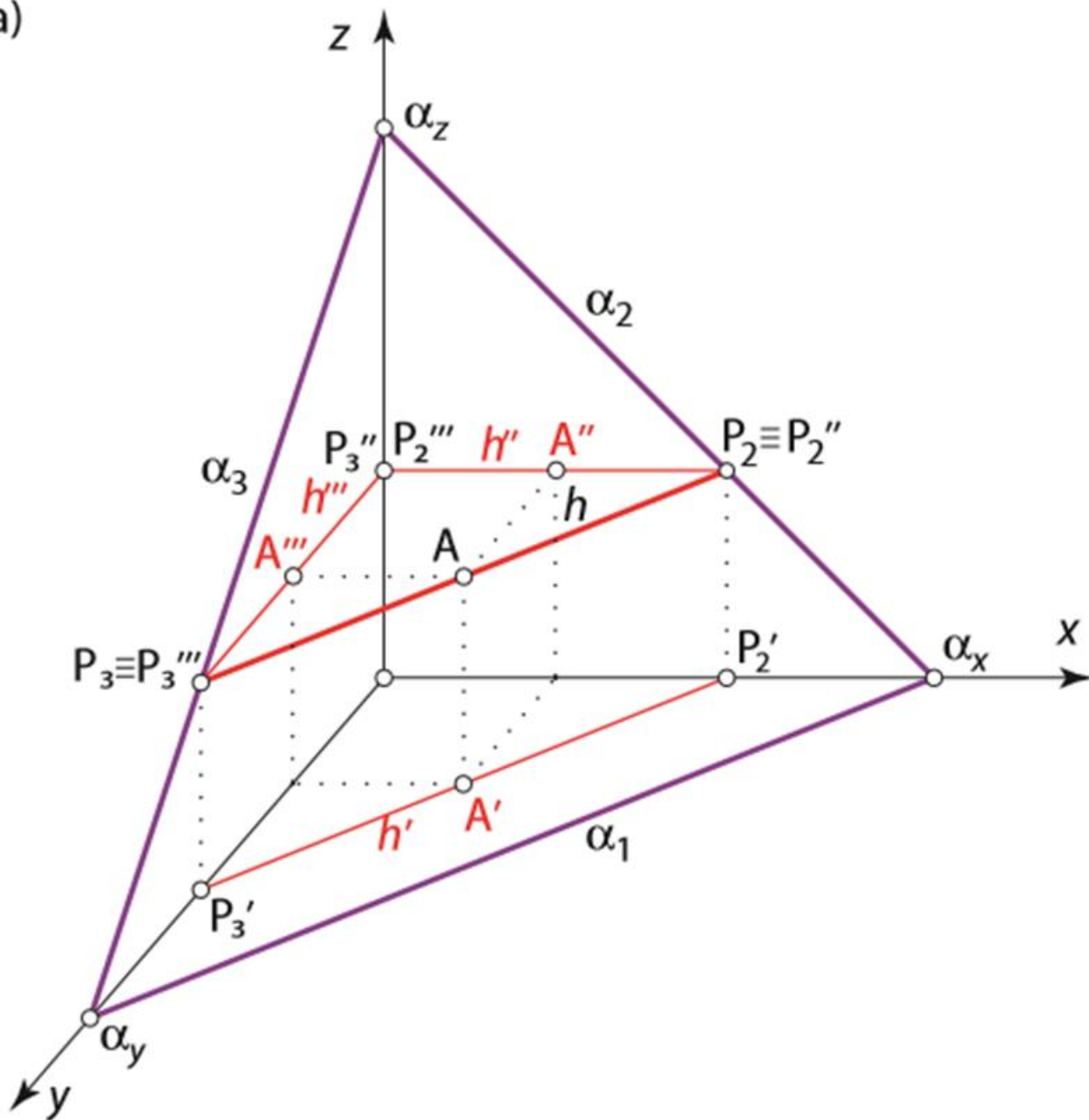

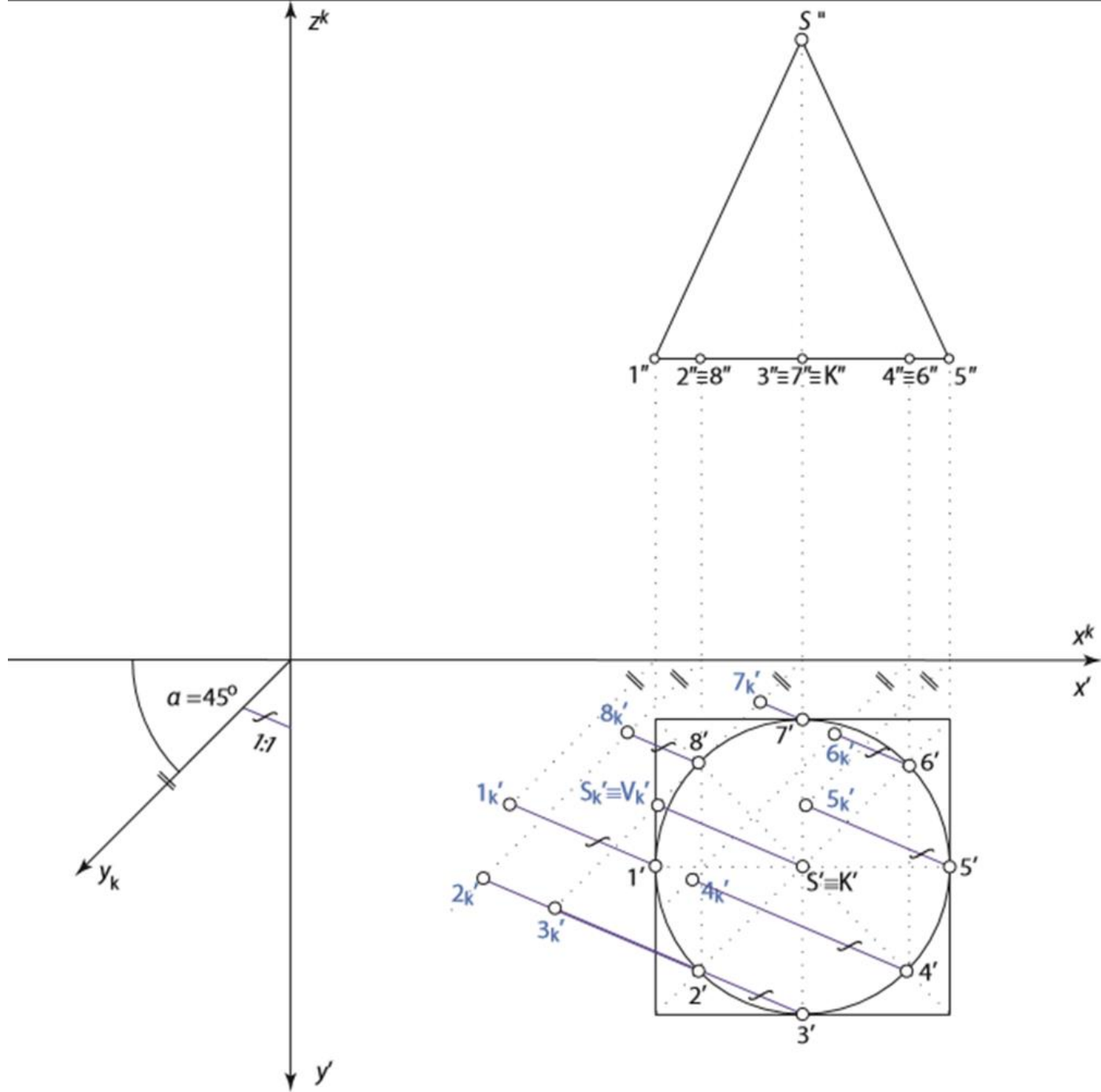

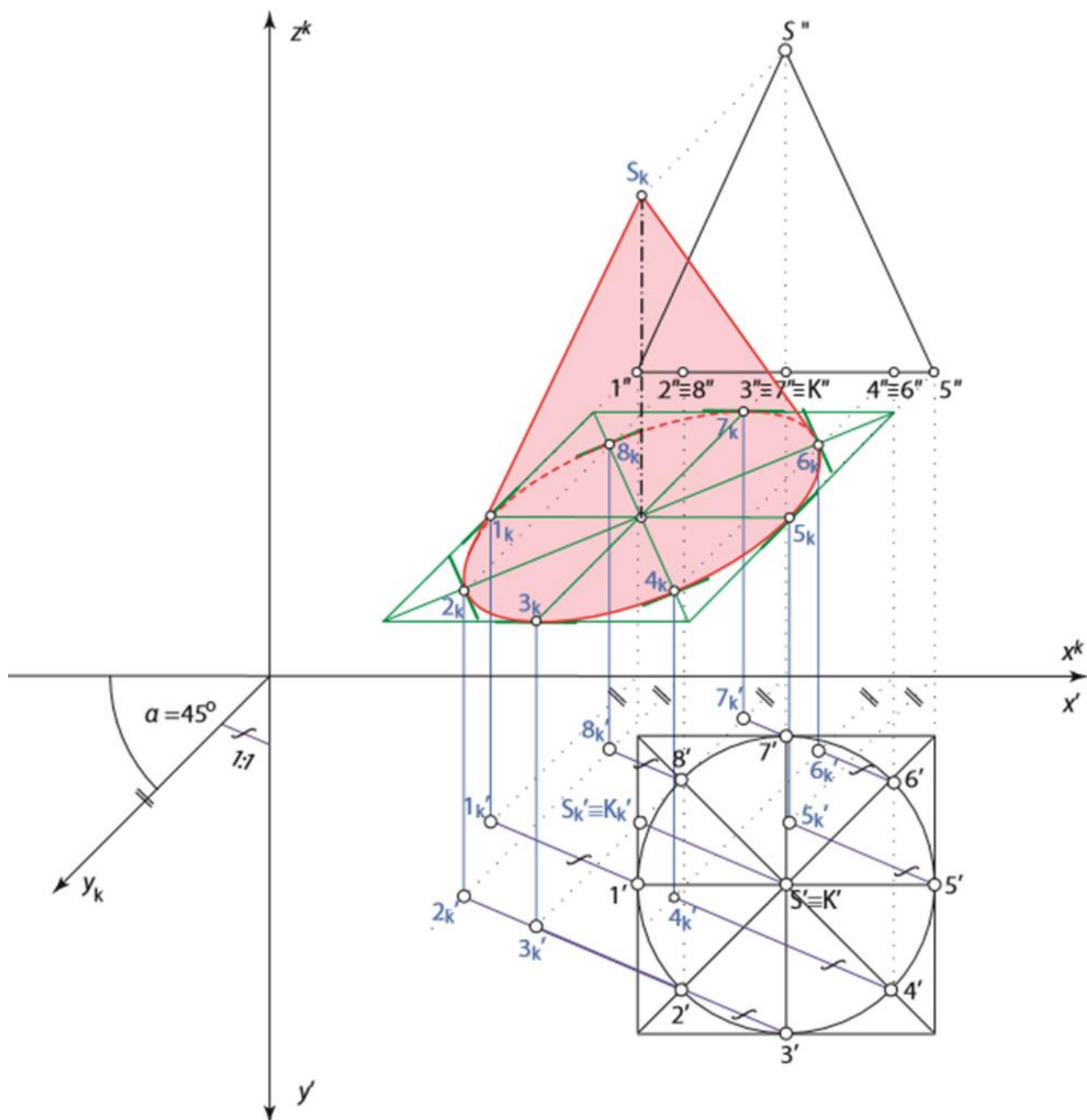

a)

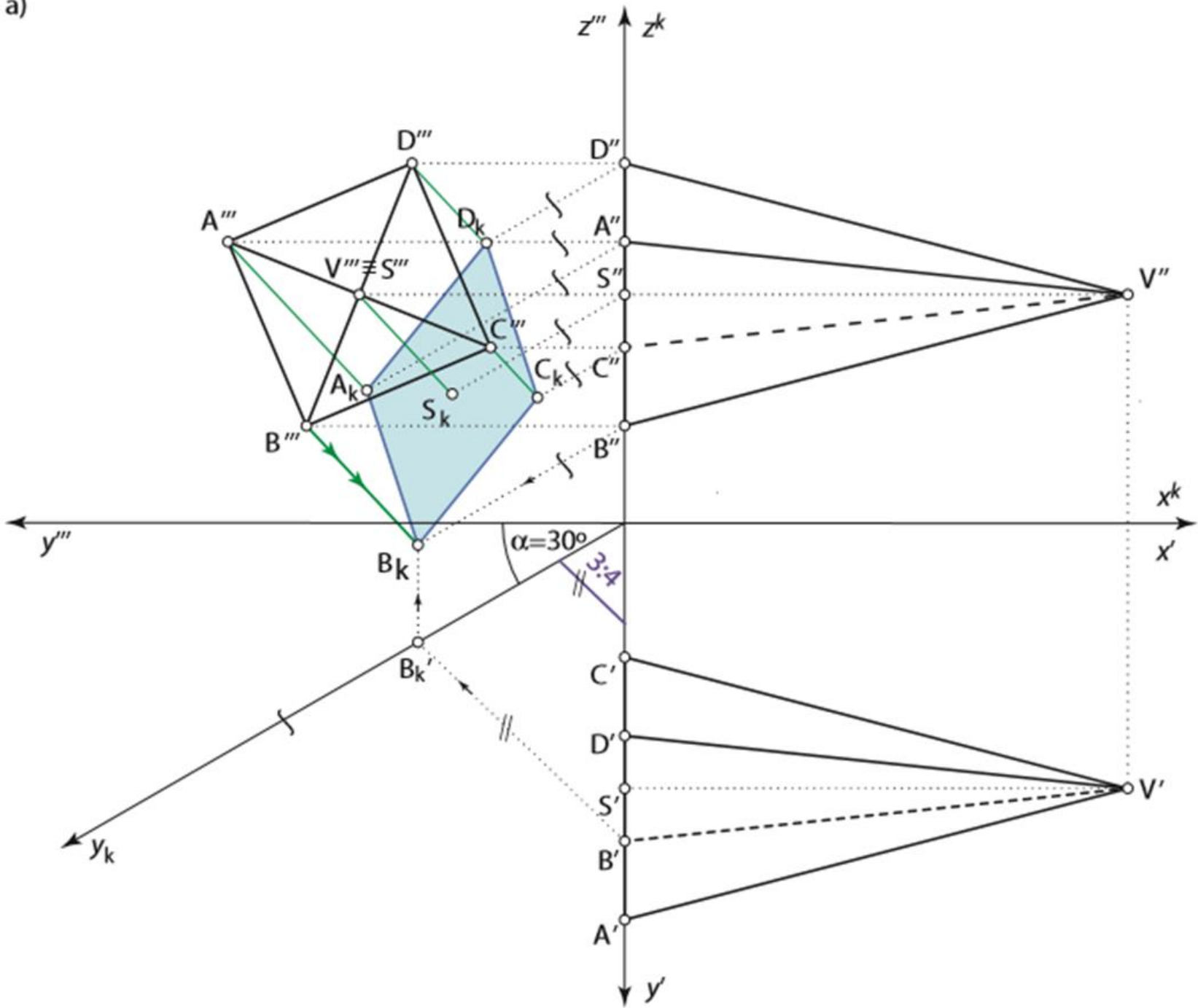

b)

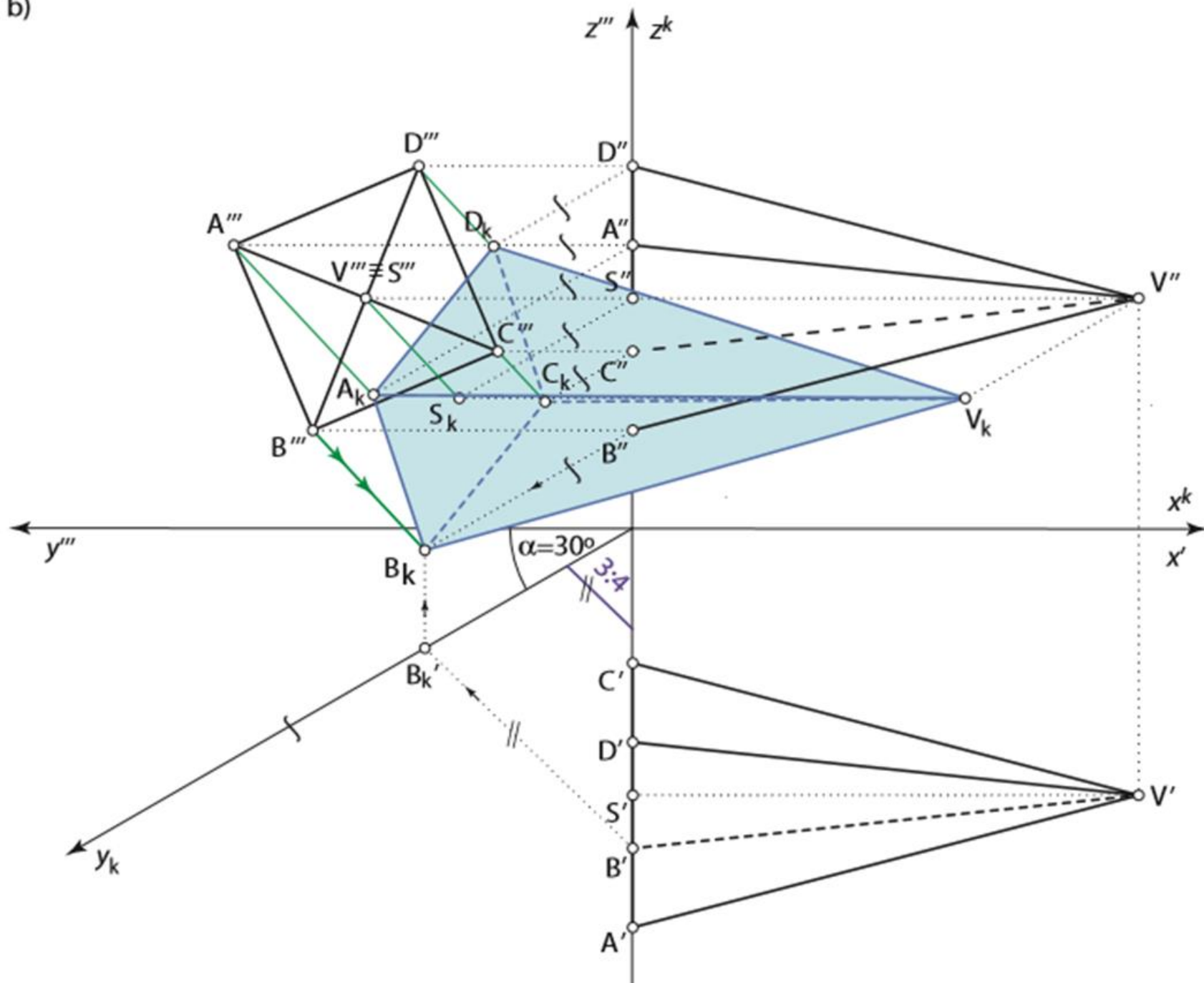



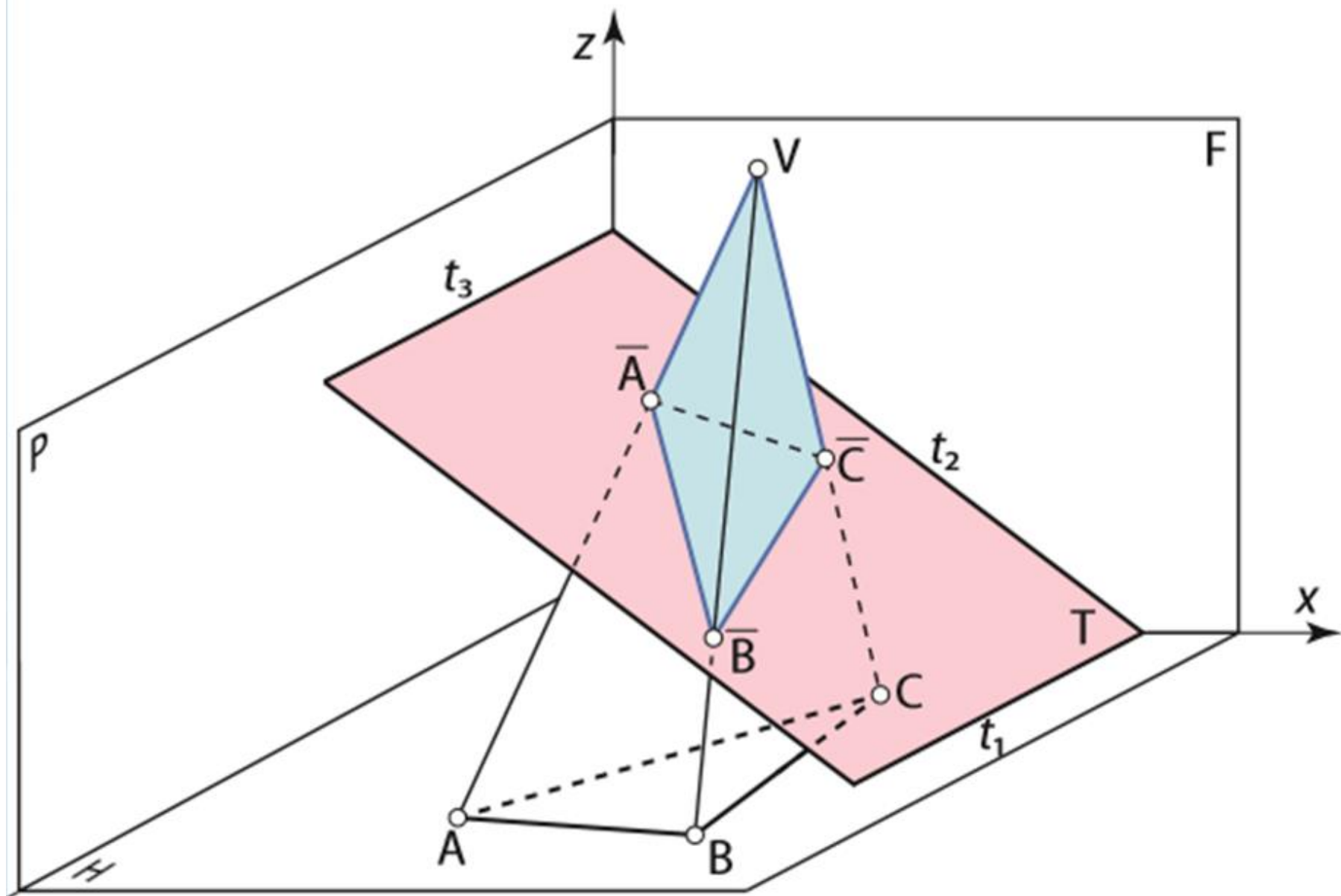

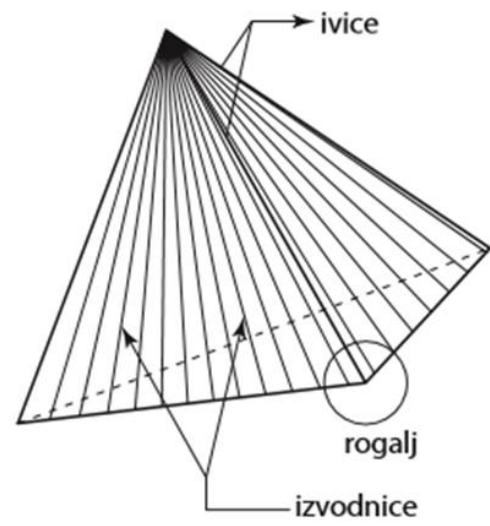
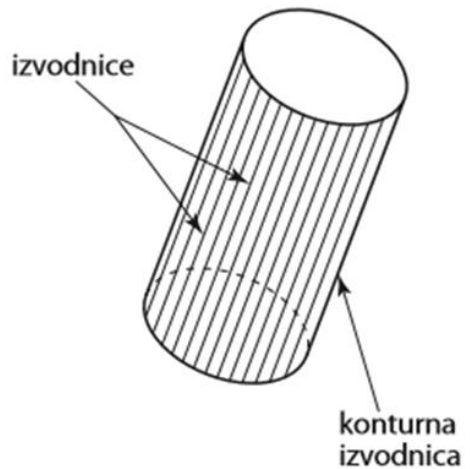
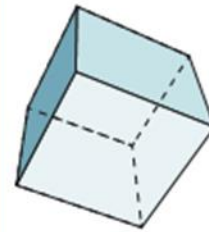
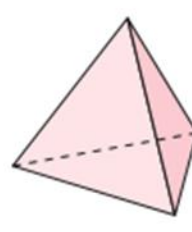
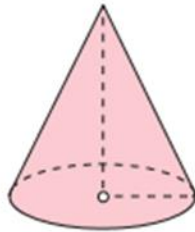
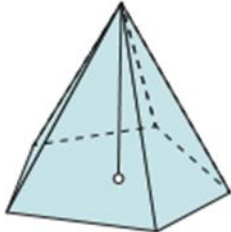
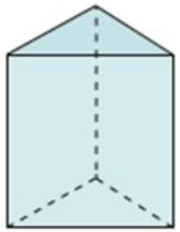
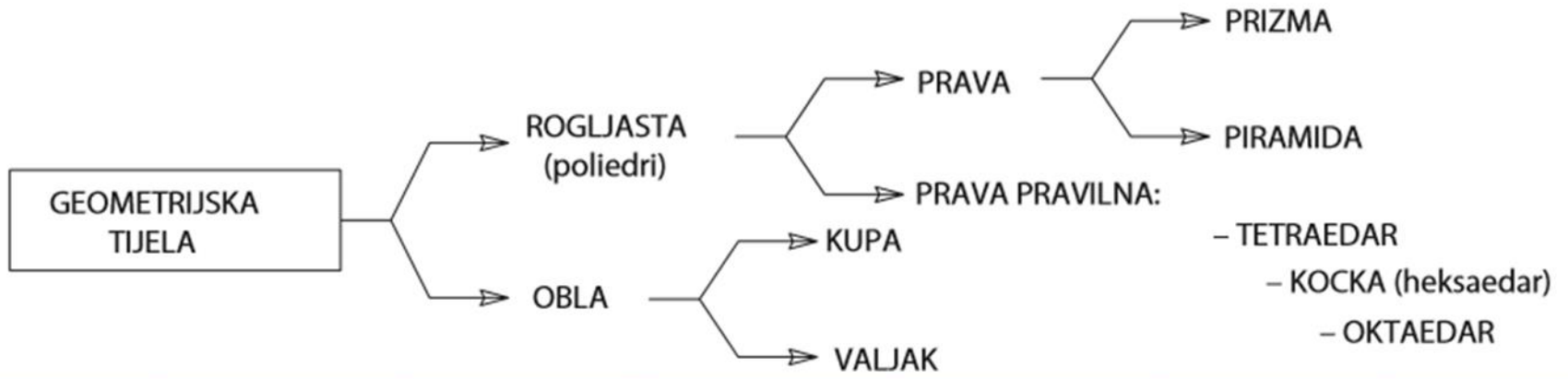

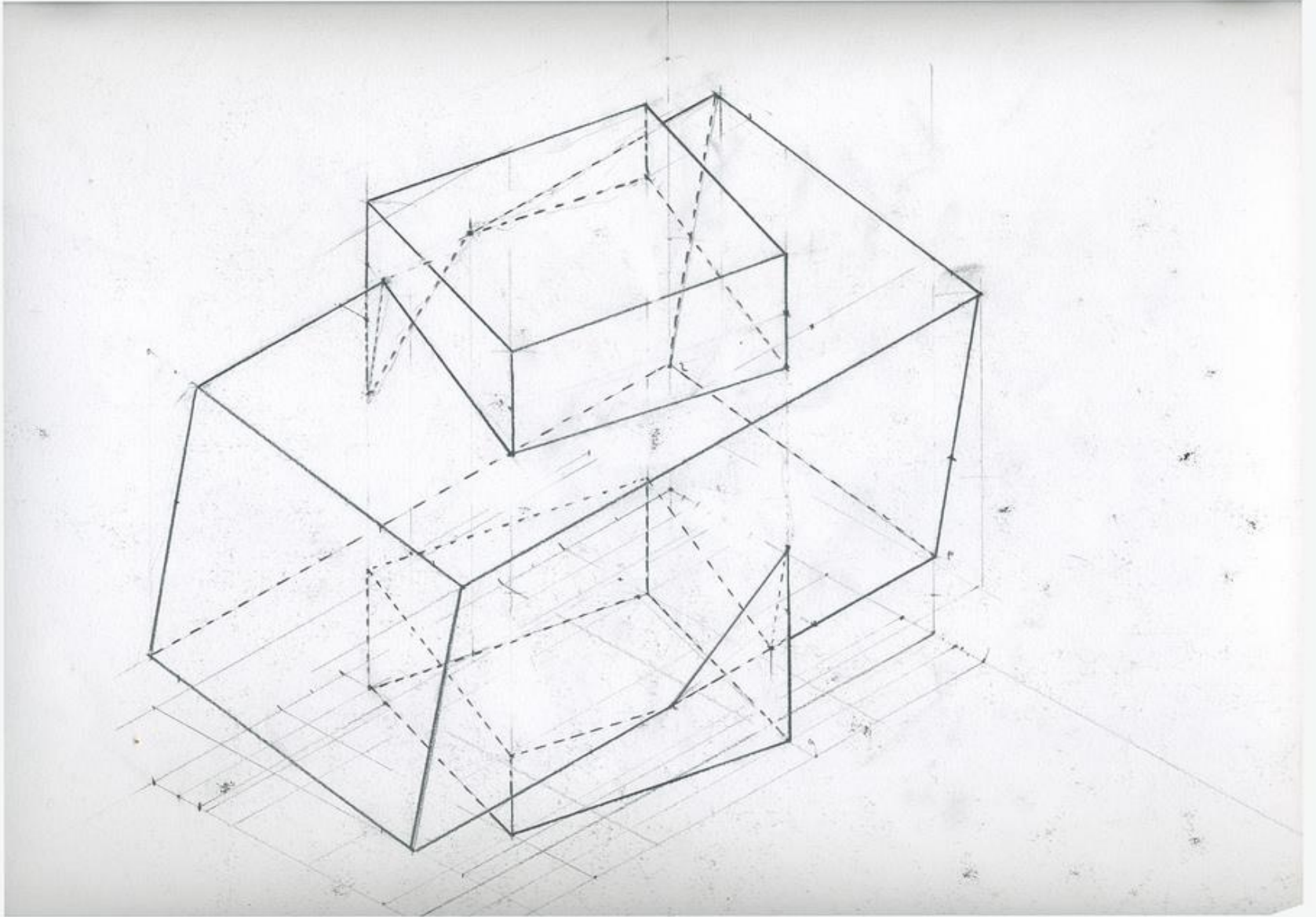

Prodor prave kroz ravan

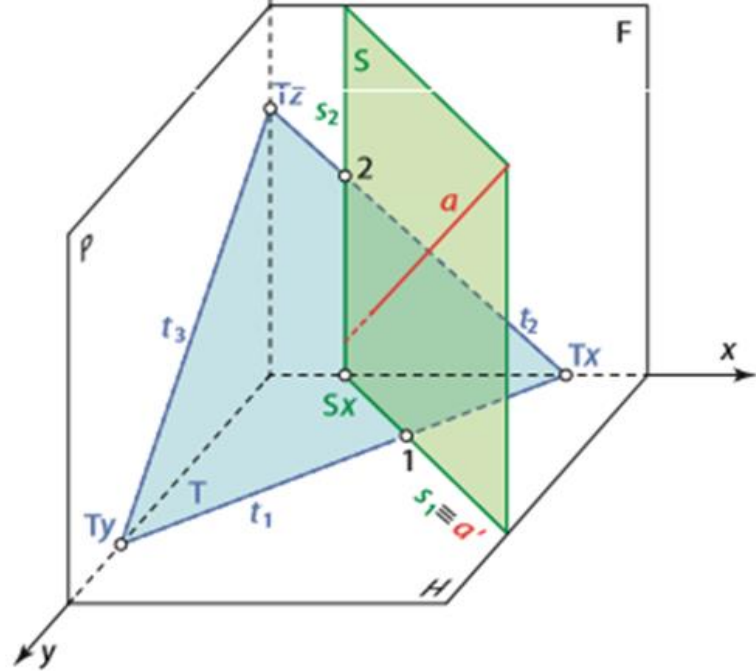
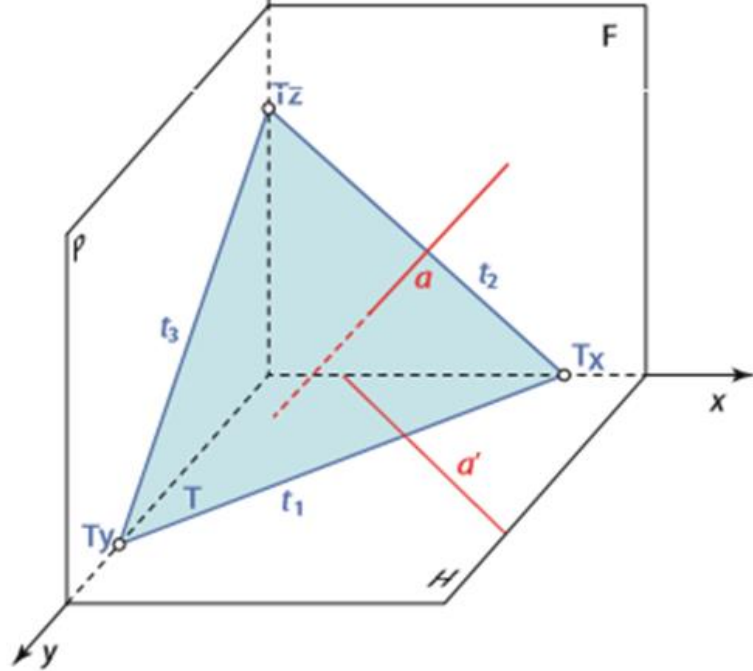

c)

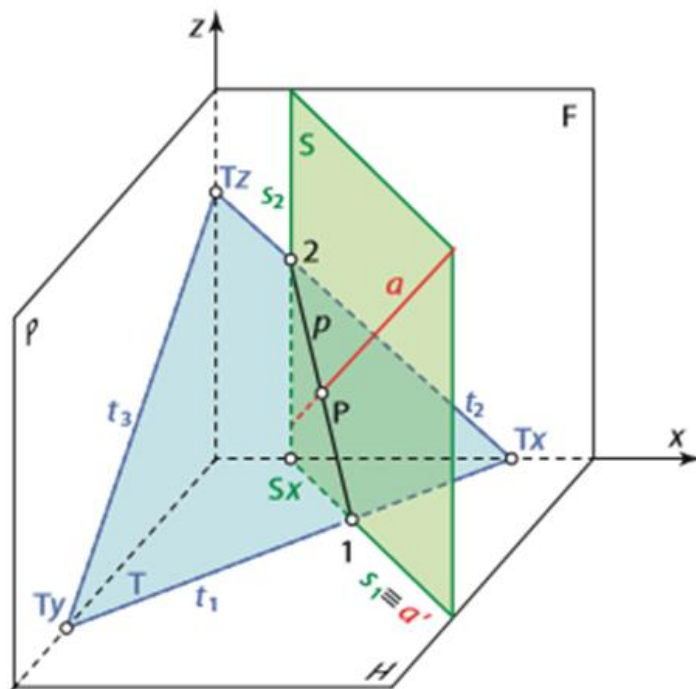

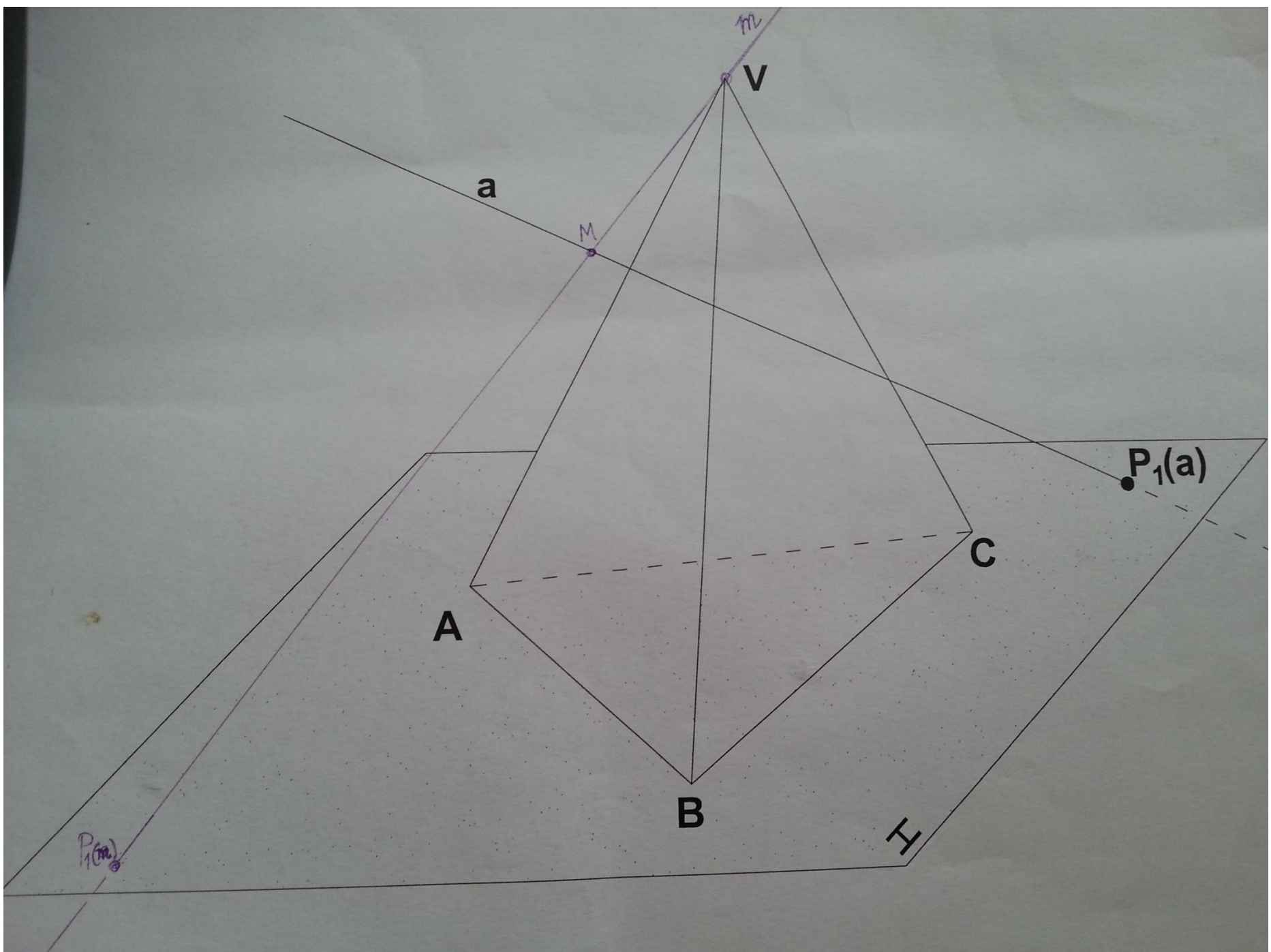

Pripadnost prave i tačke ravni

$$m \in T \Leftrightarrow P_1 \in t_1 \wedge P_2 \in t_2 \wedge P_3 \in t_3$$

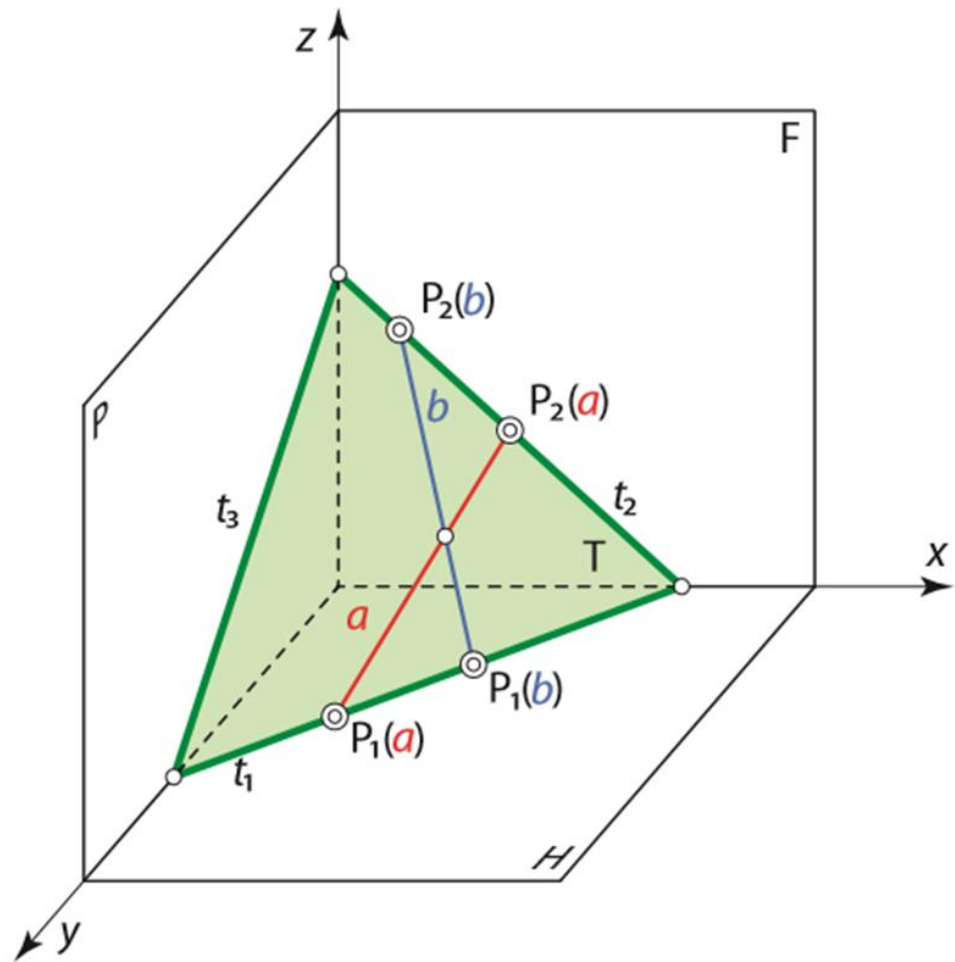
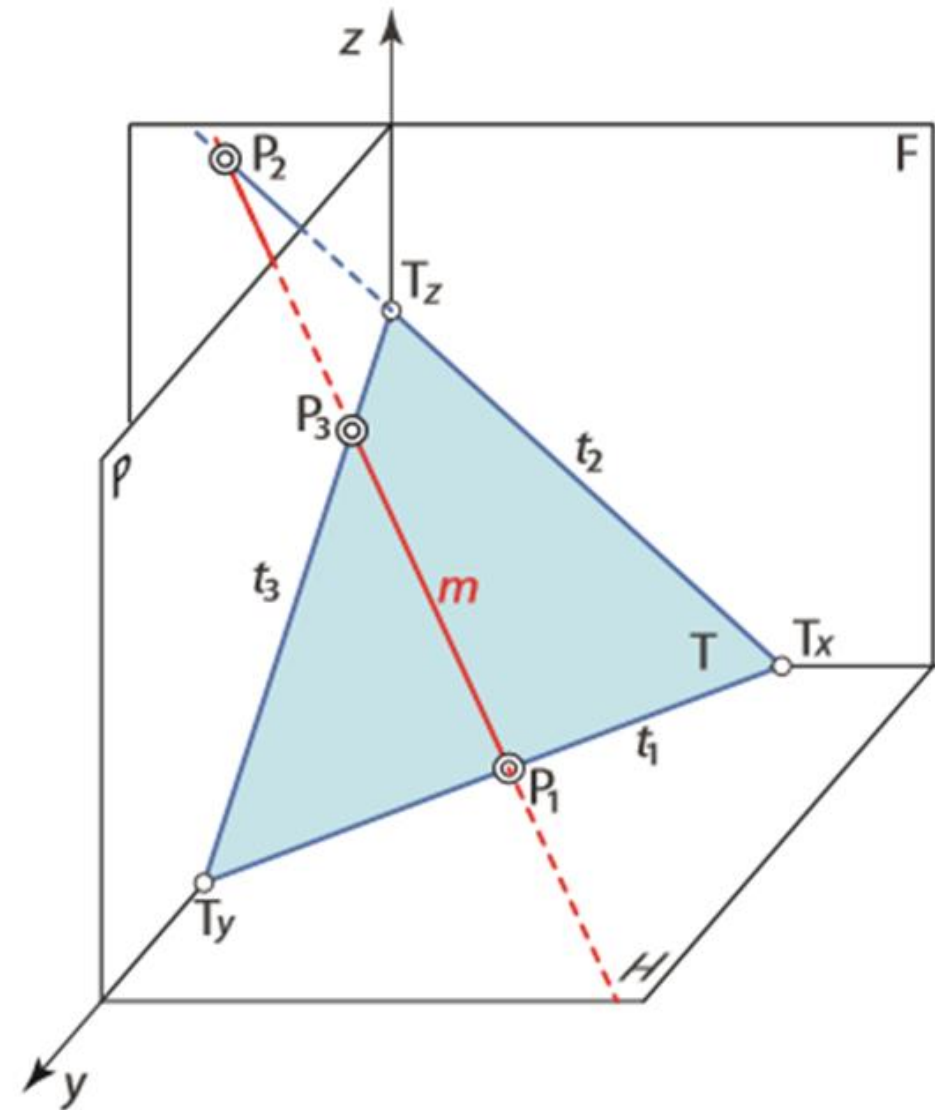

TM

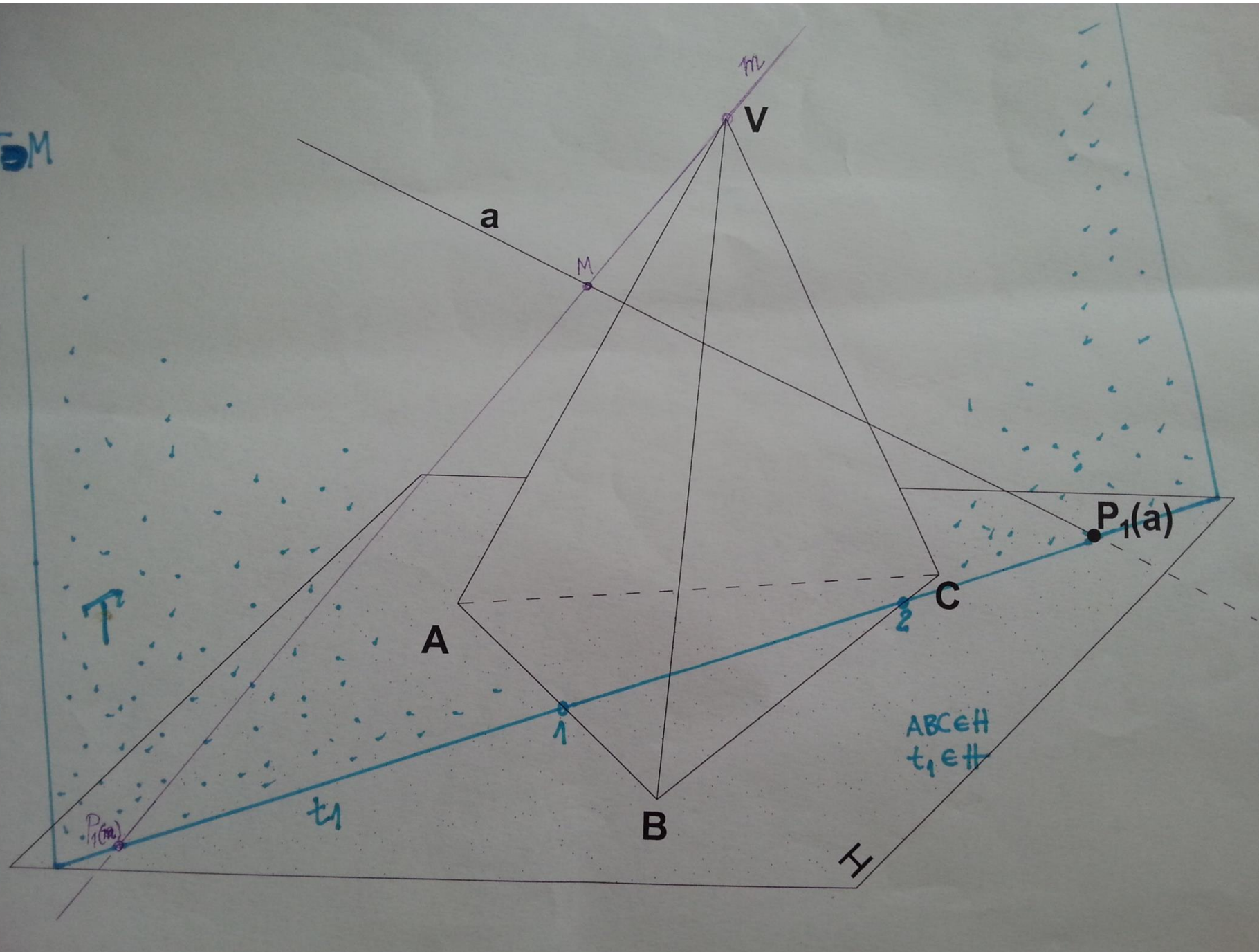

$P_1(m)$

t_1

A

B

C

Π

M

V

a

$P_1(a)$

$ABCEH$
 $t_1 \in \Pi$

2

T

... roudn rogiastin tijela

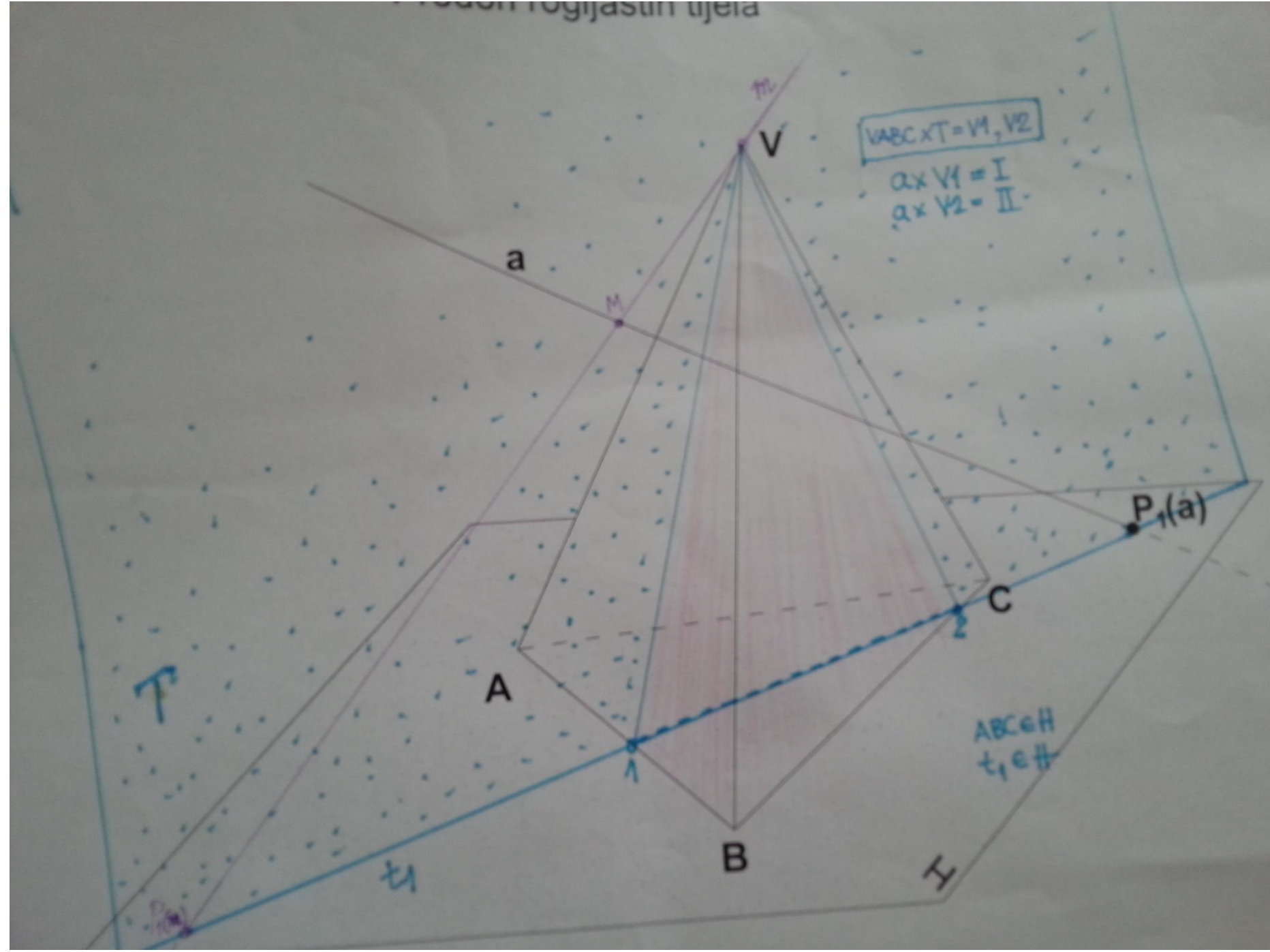

$VABC \times T = V1, V2$

$a \times V1 = I$

$a \times V2 = II$

$ABCEH$
 $t_1 \in H$

T

a

M

V

V

$P_1(a)$

A

C

A'

B

H

t_1

$P_2(a)$

Projeon togijastin tijela

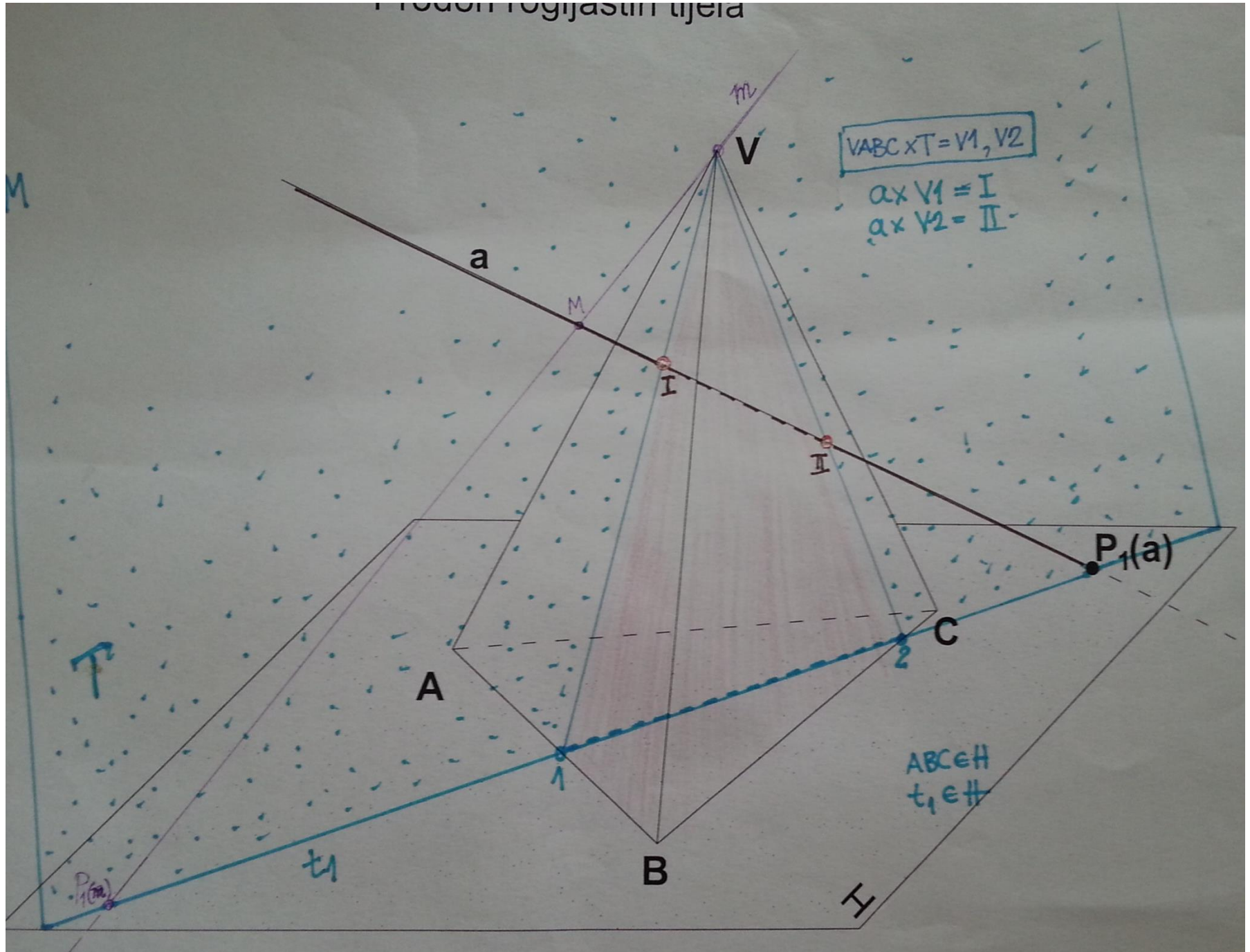

Nacrtna geometrija - Predavanja
Prodori rogljastih tijela

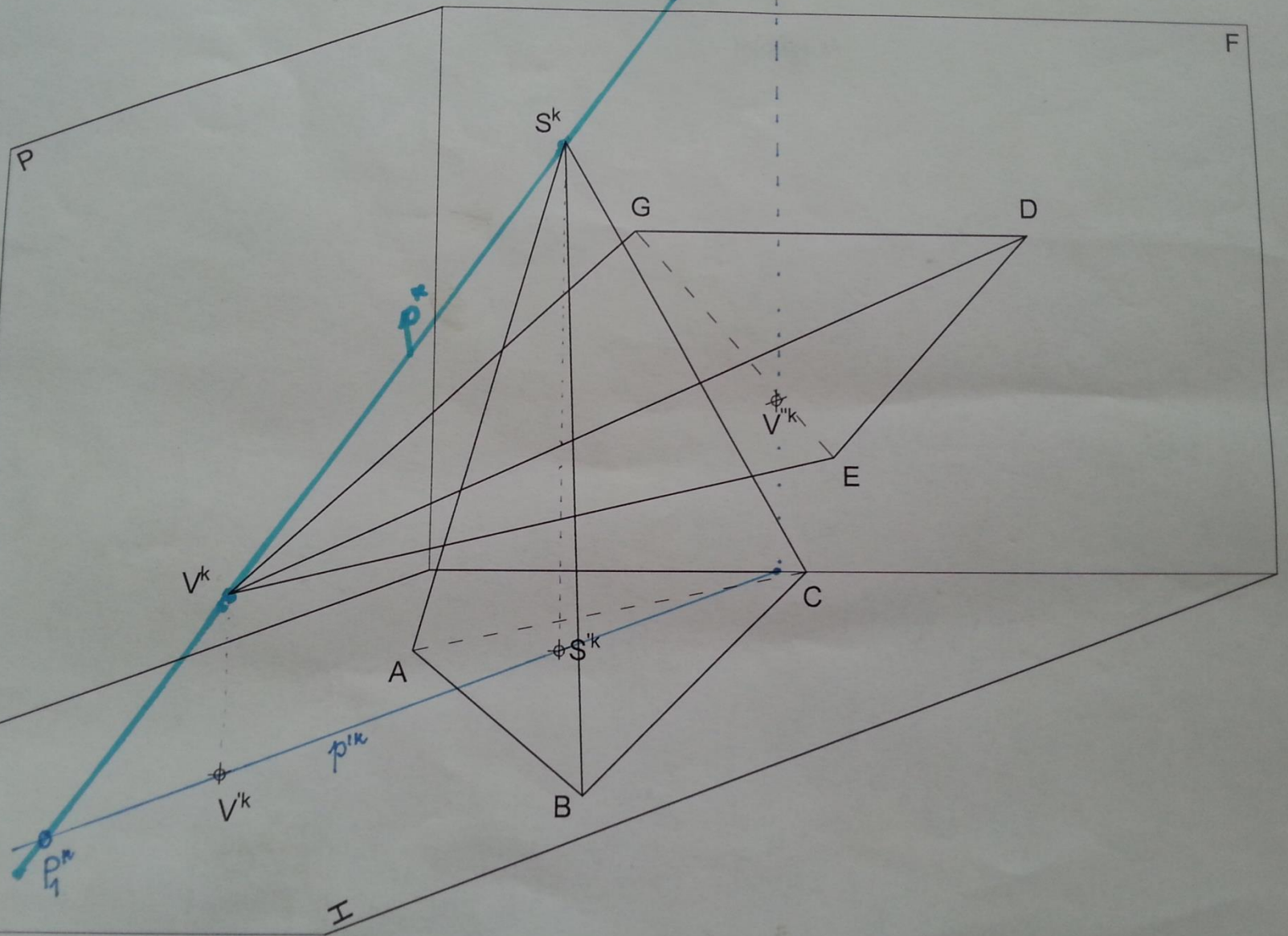

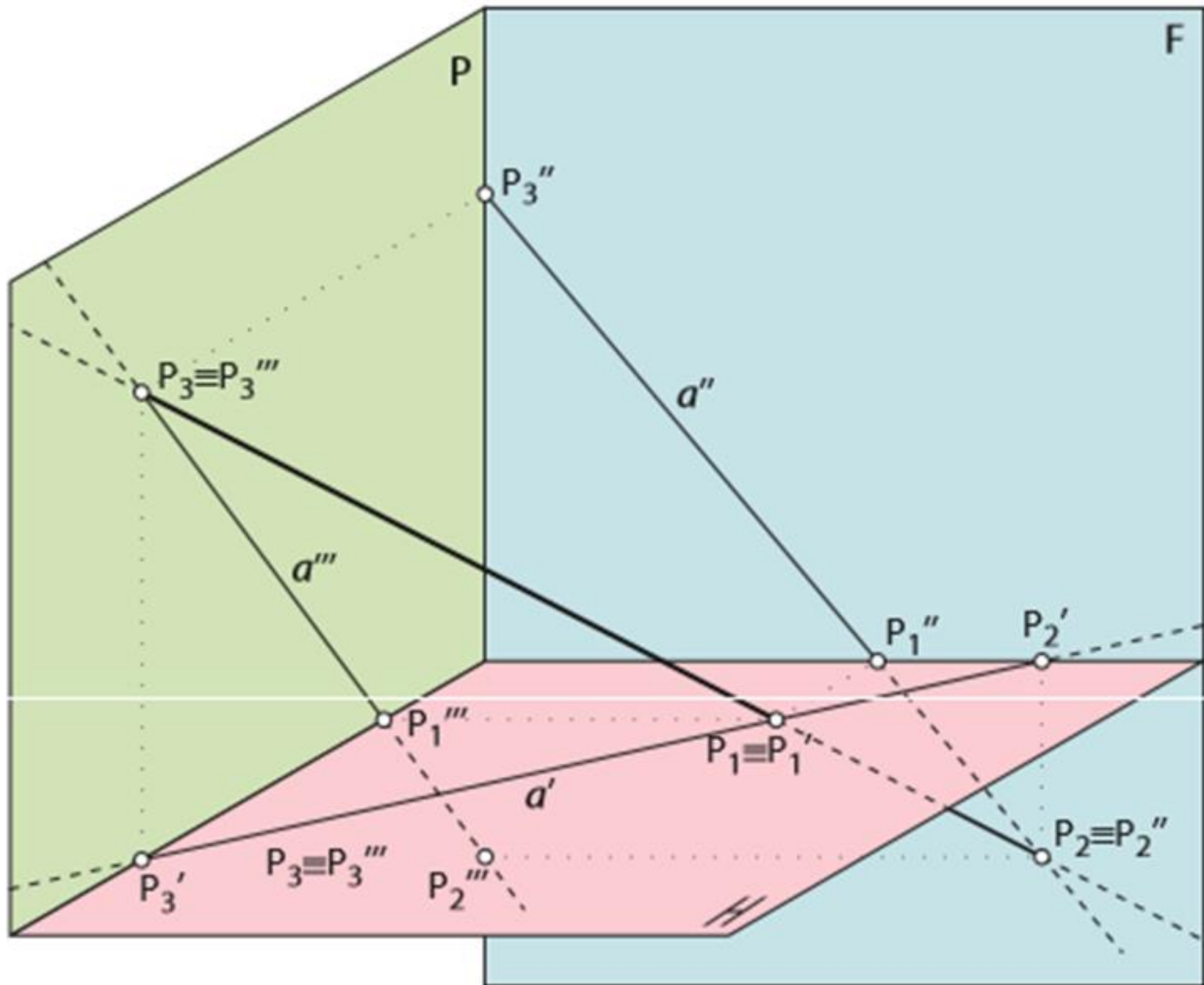

Nacrtna geometrija - Predavanja
 Prodori rogljastih tijela

- 4;4;0)
- 13;11;0)
- 6⁵;0;0)
- 6;4;9)
- 10⁵;0;6)
- 7;0;2)
- 3⁵;0;6)
- 6;10;3)

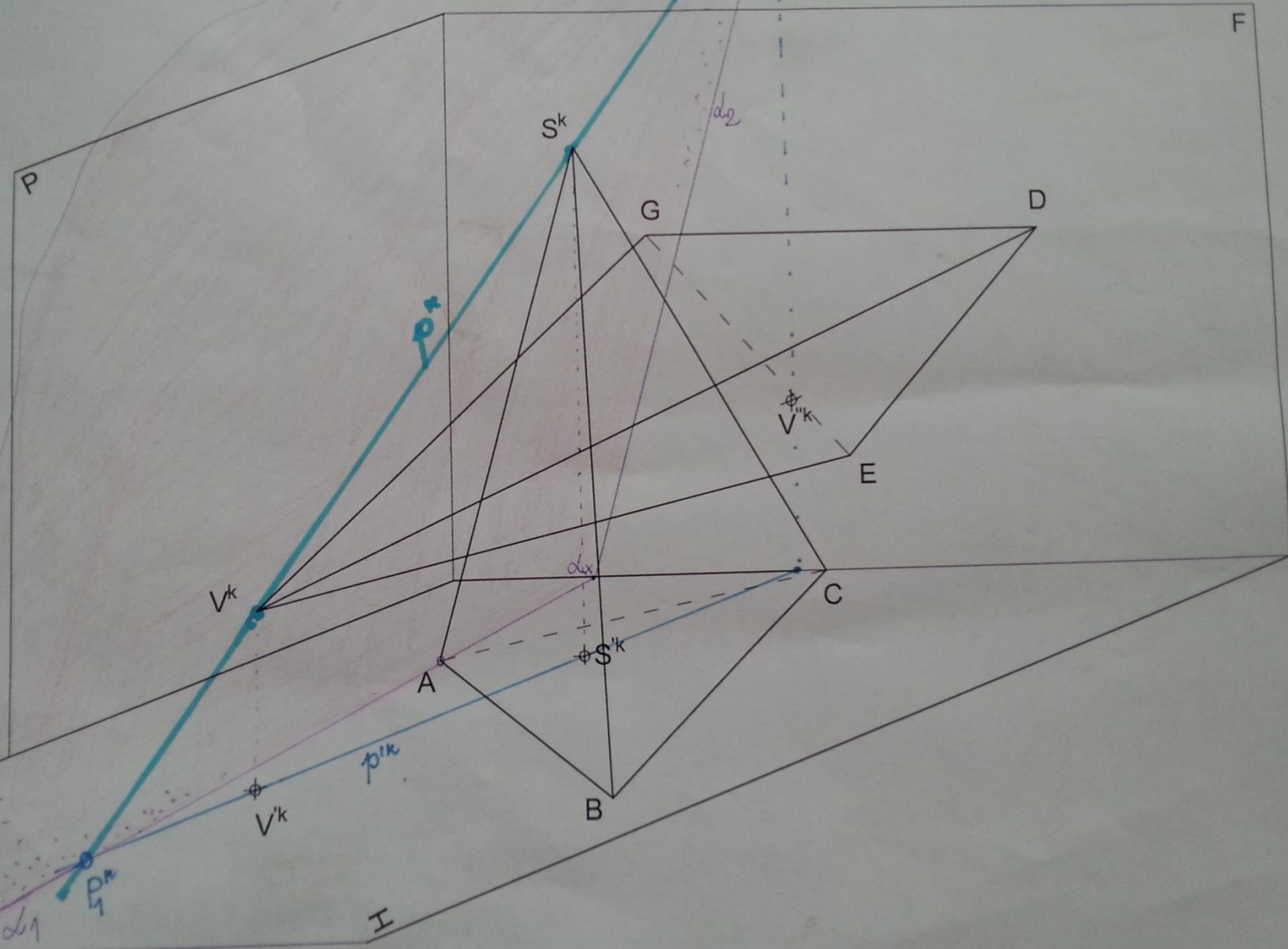

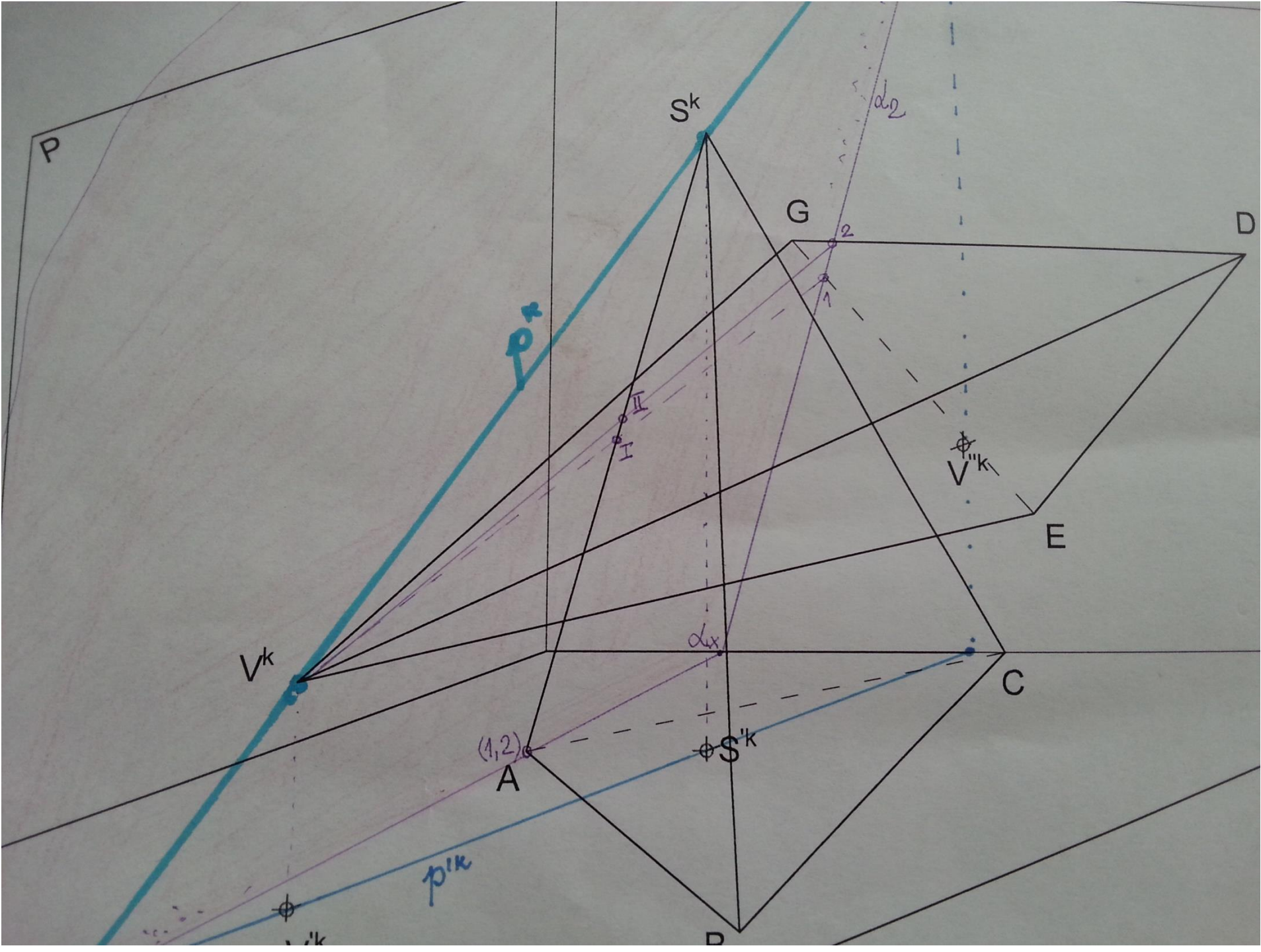

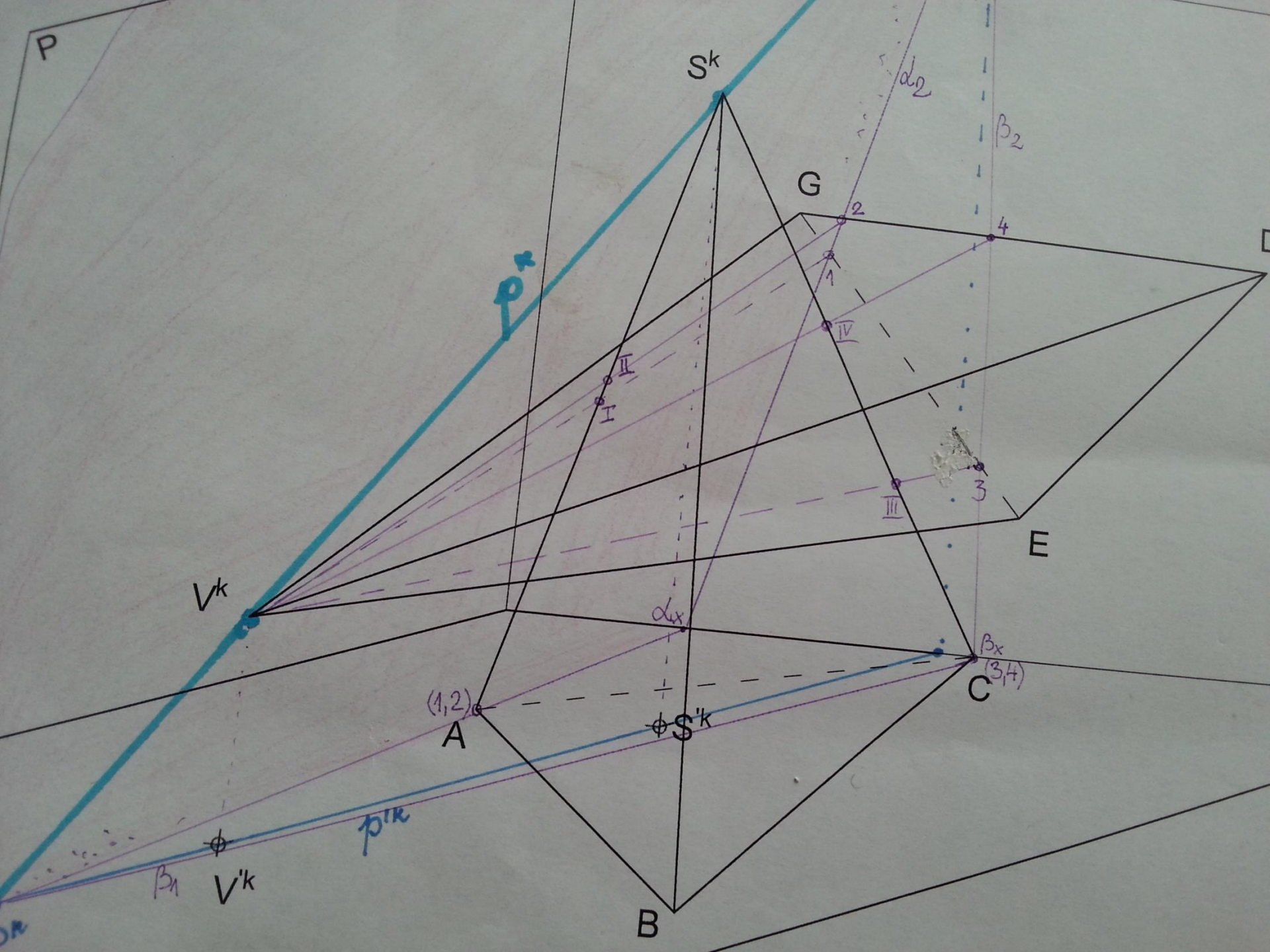

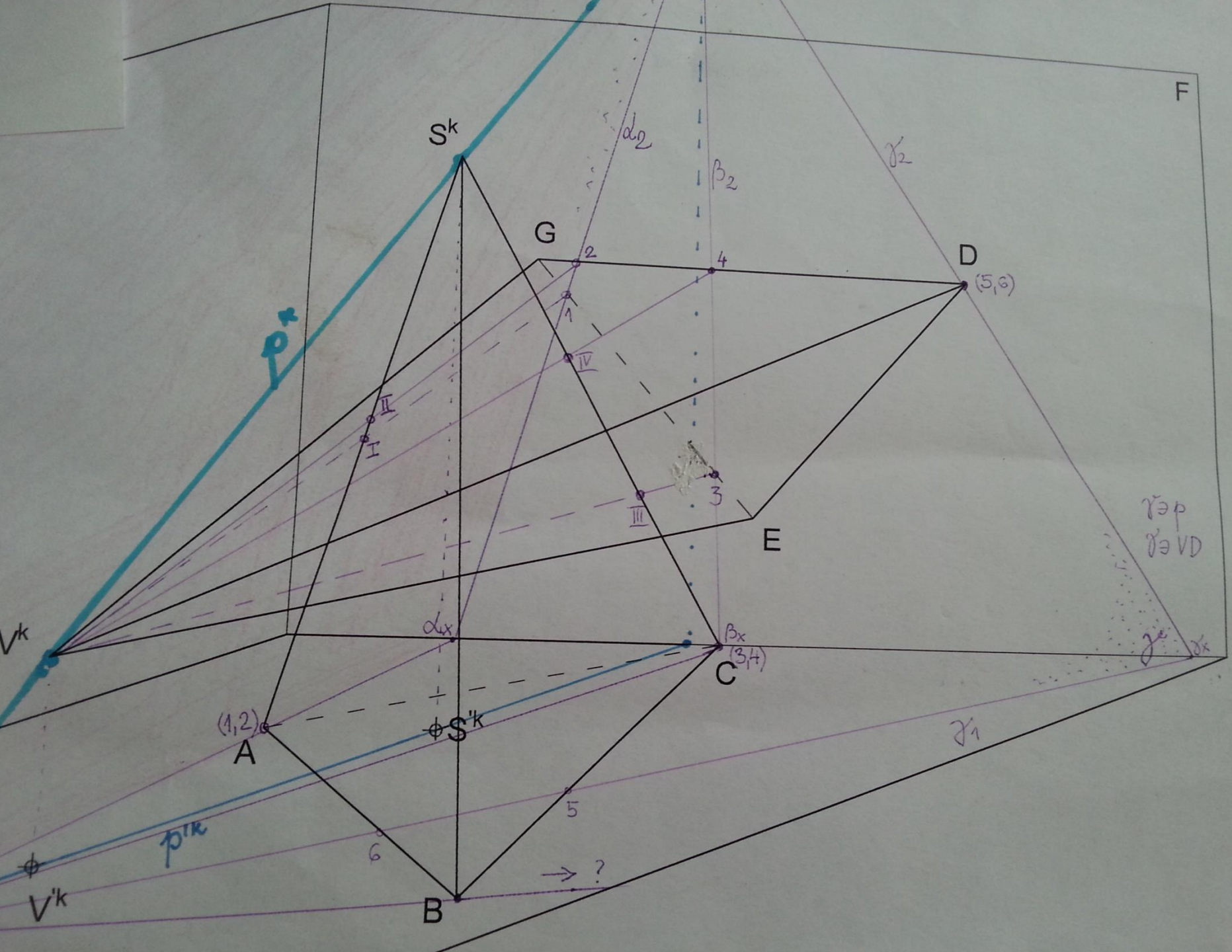

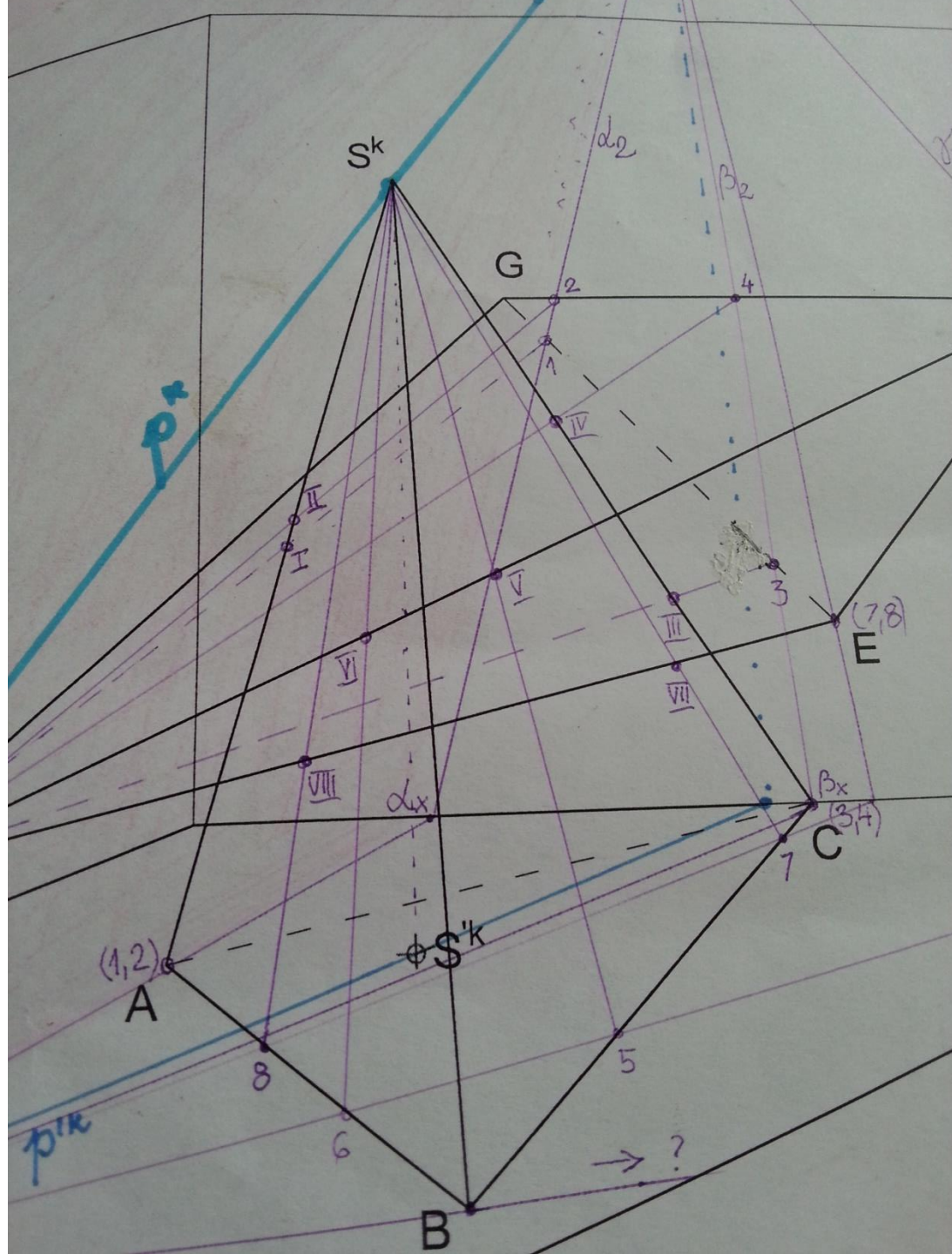

Geometrija - Predavanja Duglastih tijela

IV: 256
1275

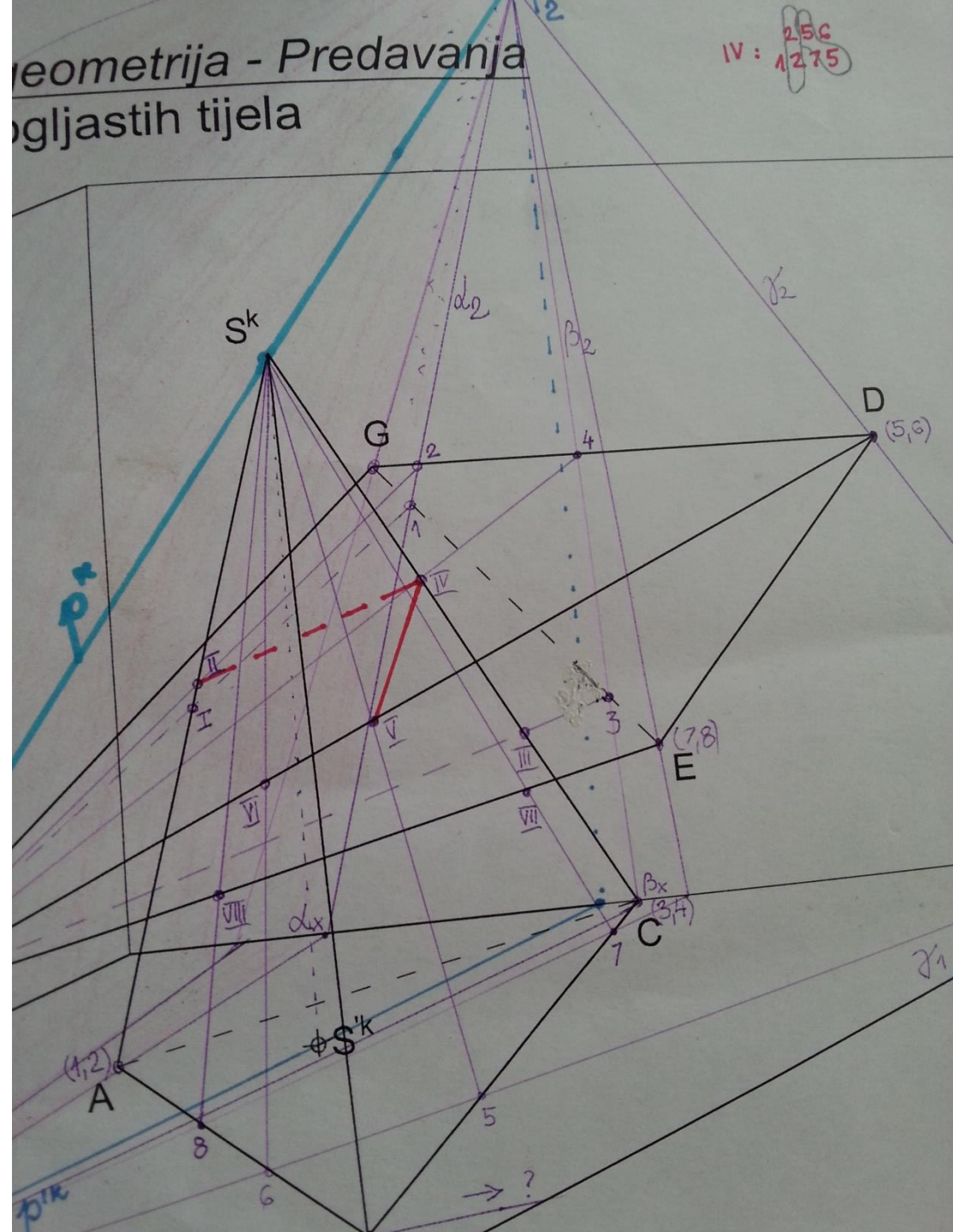

Nacrtna geometrija - Predavanja
Prodori rogljastih tijela

IV: 256
1275

VII: 345
1356

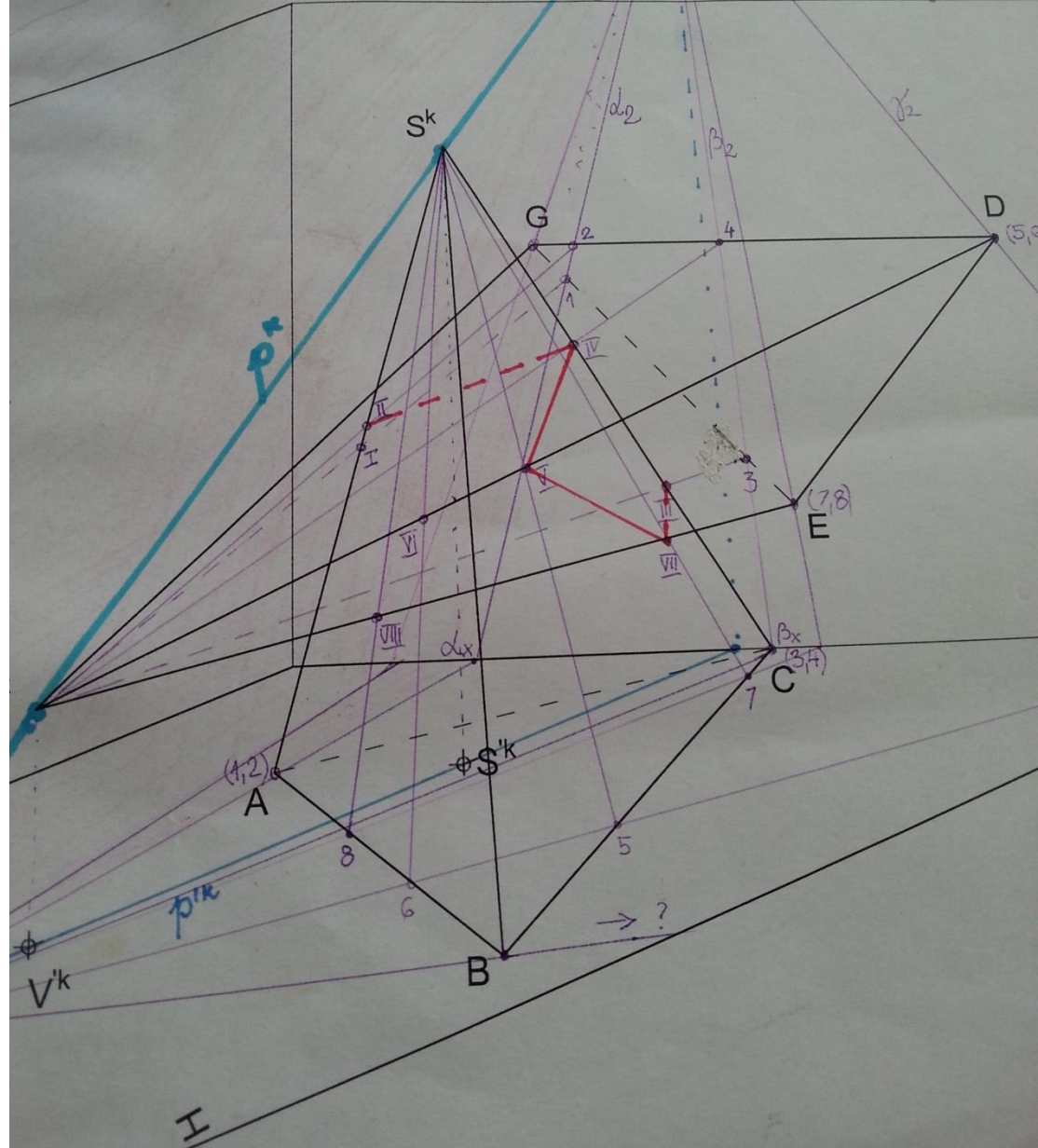

metrija - Predavanja
astih tijela

IV: 256
1275

VII: 345
1356

VI: 842
2478

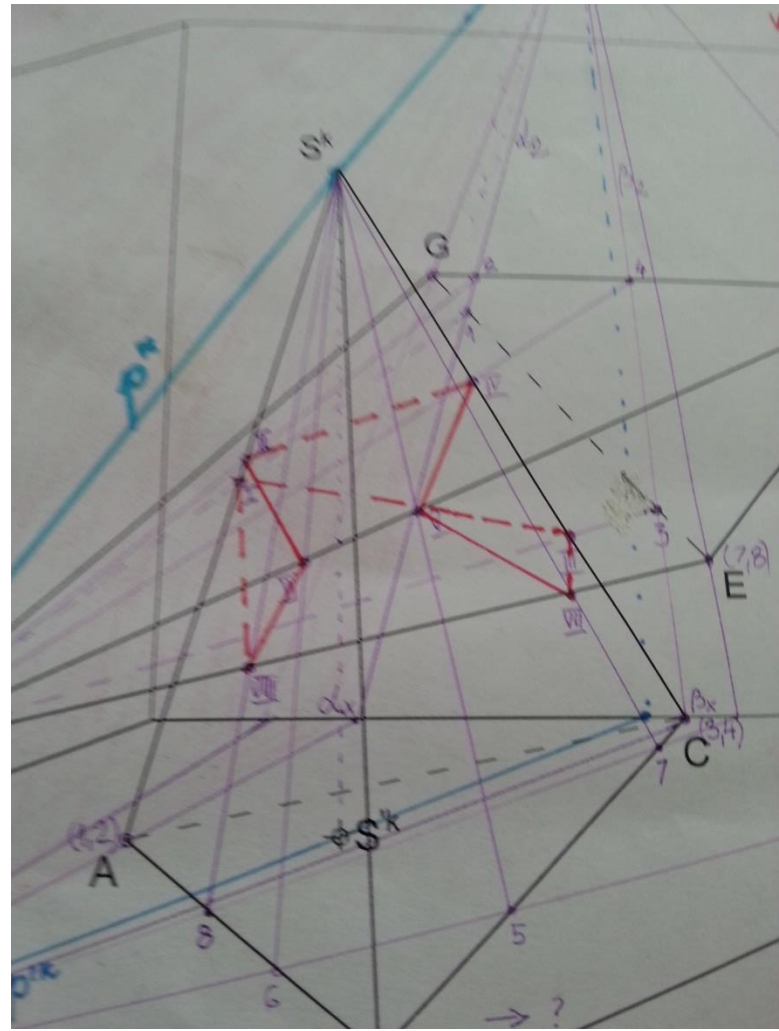
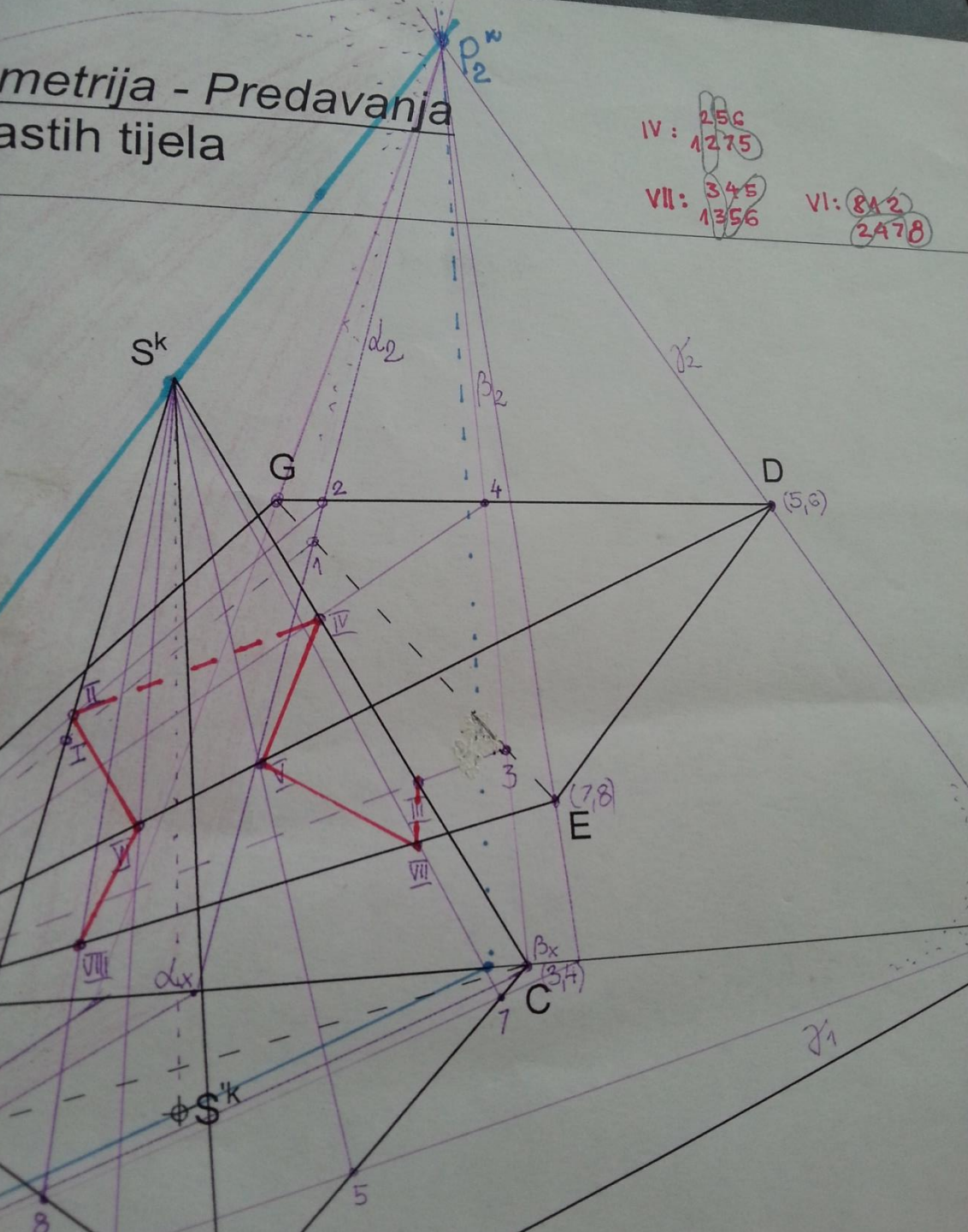

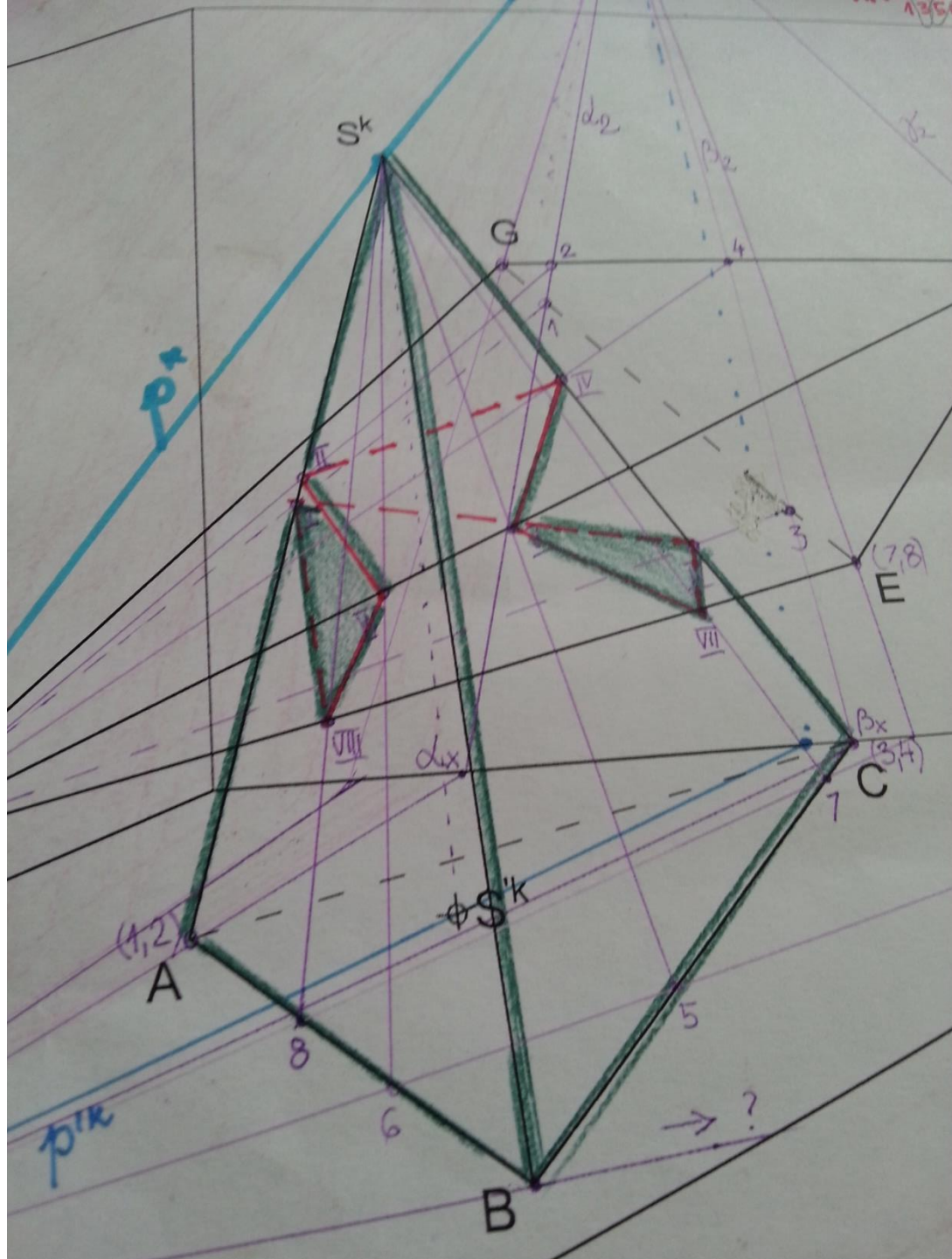

Prodor oblih tijela

1. Postavljanje pramenjače

2. Određivanje prodora pramenjače kroz one projekcijske ravni u kojima leže bazisi tijela

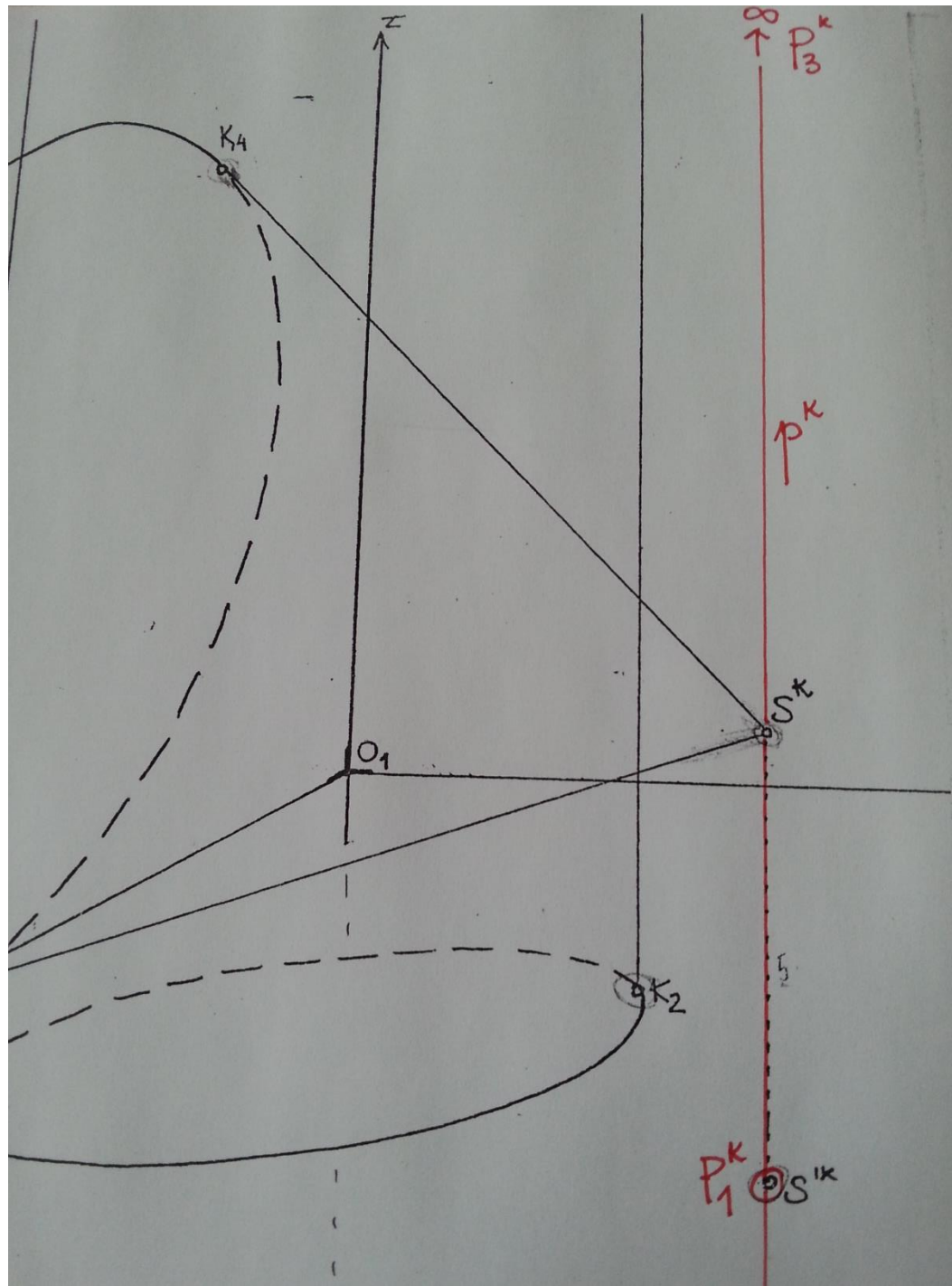

3. Postavljanje
pomoćnih ravni:
a) kroz konturne
izvodnice

ravan α

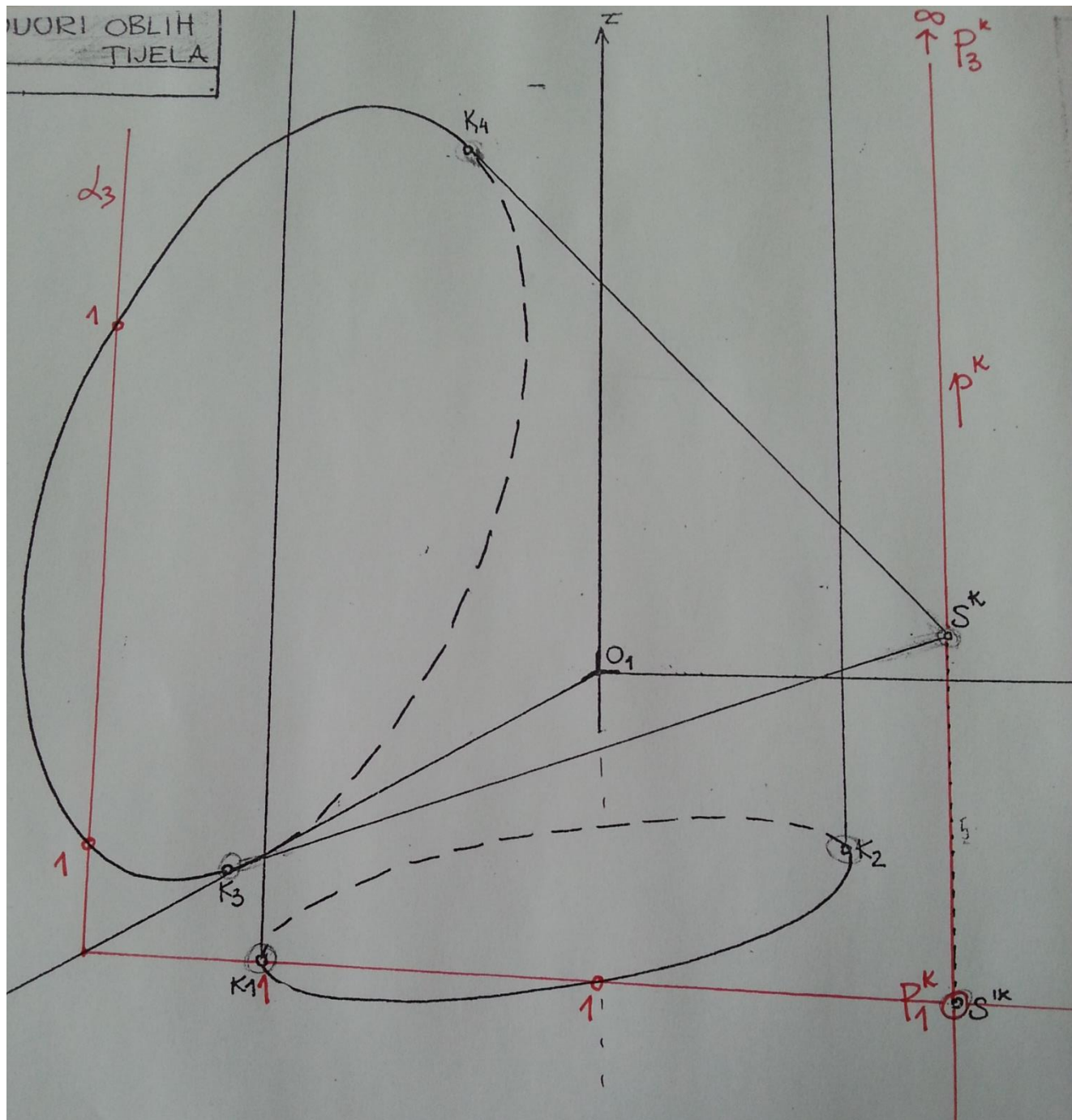

ORI OBLIH
TJELA

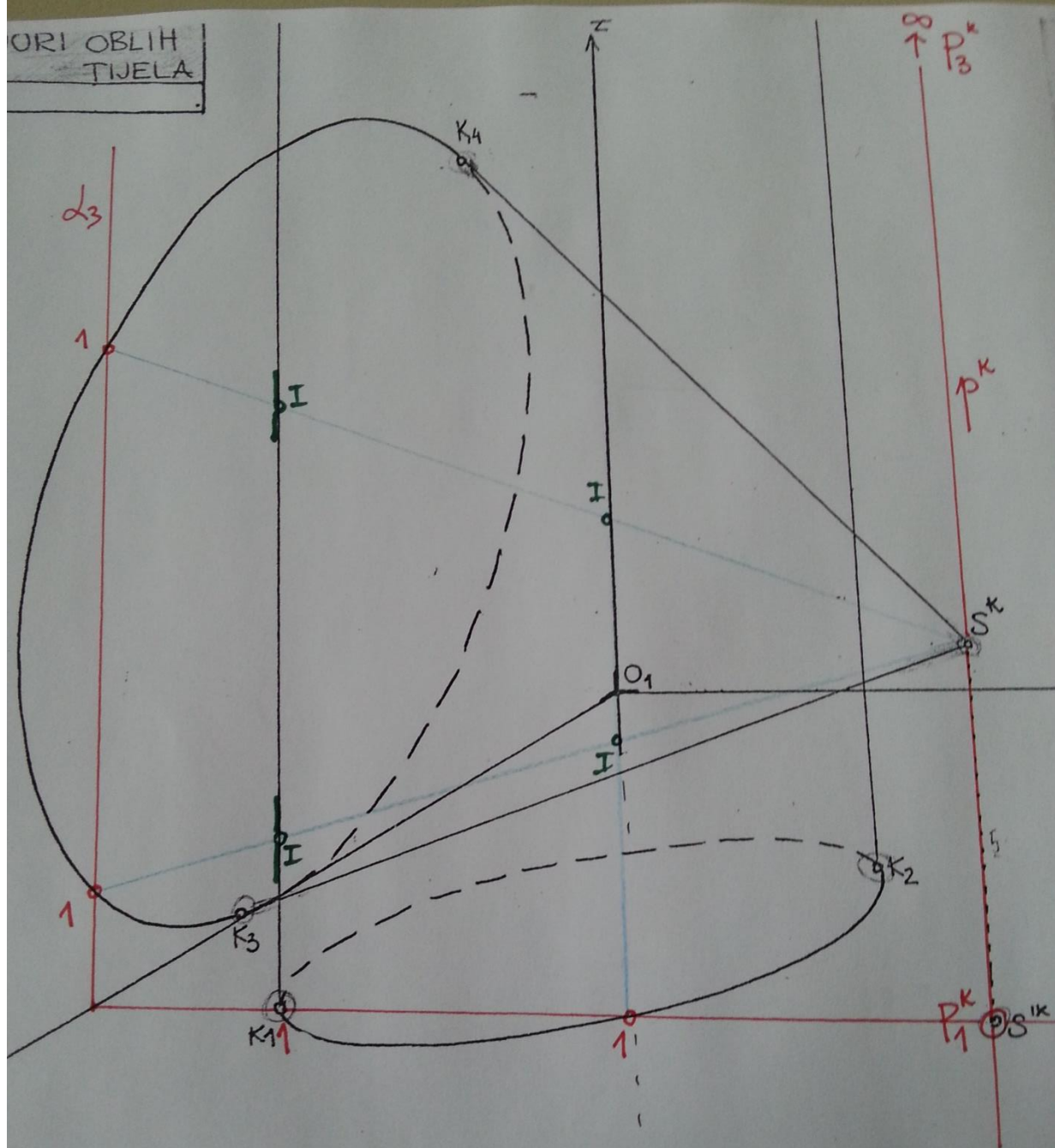

3. Postavljanje pomoćnih ravni:

a) kroz konturne izvodnice

i određivanje prodornih tačaka (I) i tangenti na prodornu krivu (u tačkama I i I' na konturnoj izvodnici kroz koju smo postavili ravan)

3. Postavljanje pomoćnih
ravni:
a) kroz konturne izvodnice
ravan β

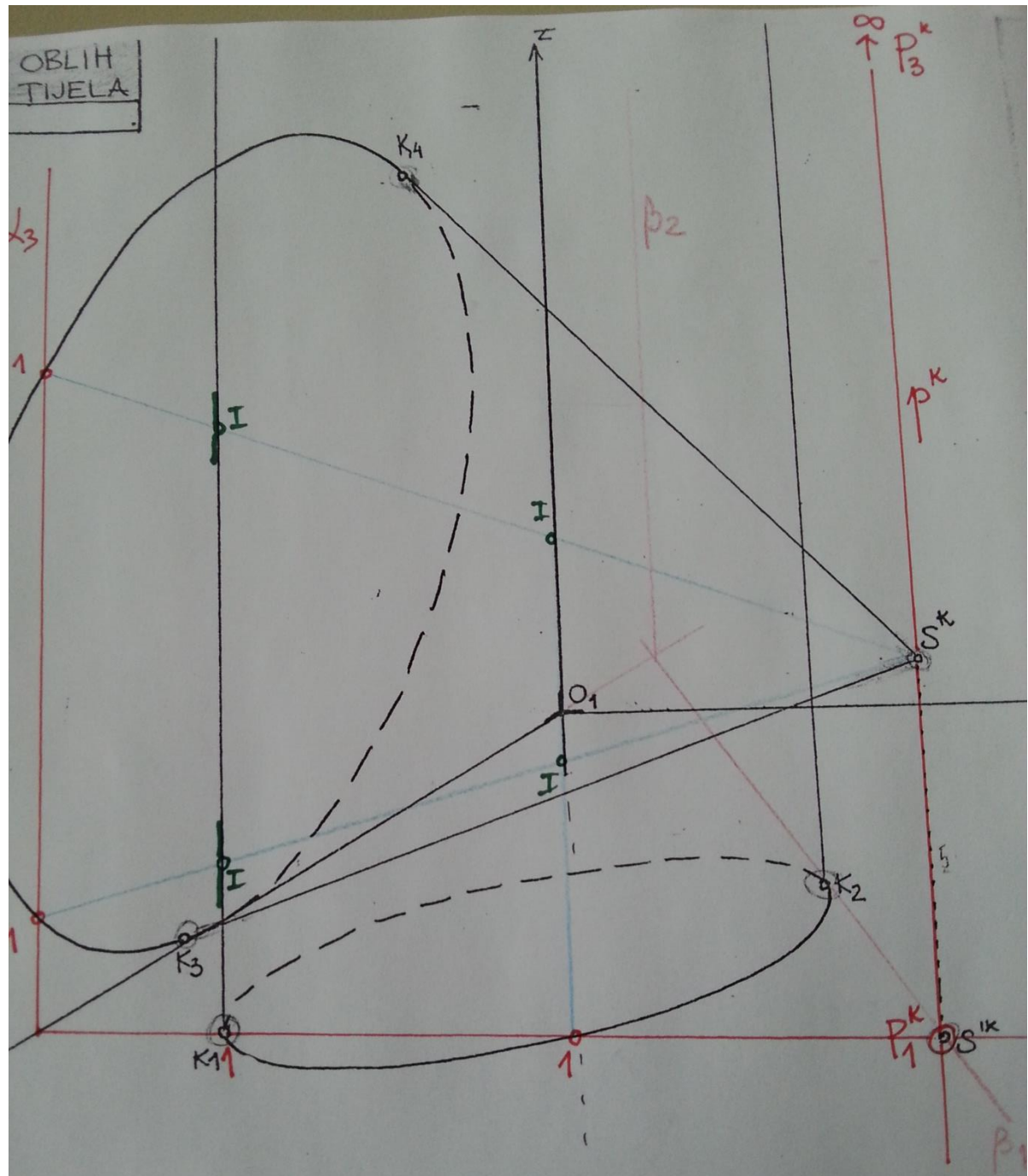

3. Postavljanje pomoćnih ravni:

a) kroz konturne izvodnice (ravan γ)

i određivanje prodornih tačaka (III) i tangenti na prodornu krivu (u tačkama III i III na konturnoj izvodnici kroz koju smo postavili ravan γ)

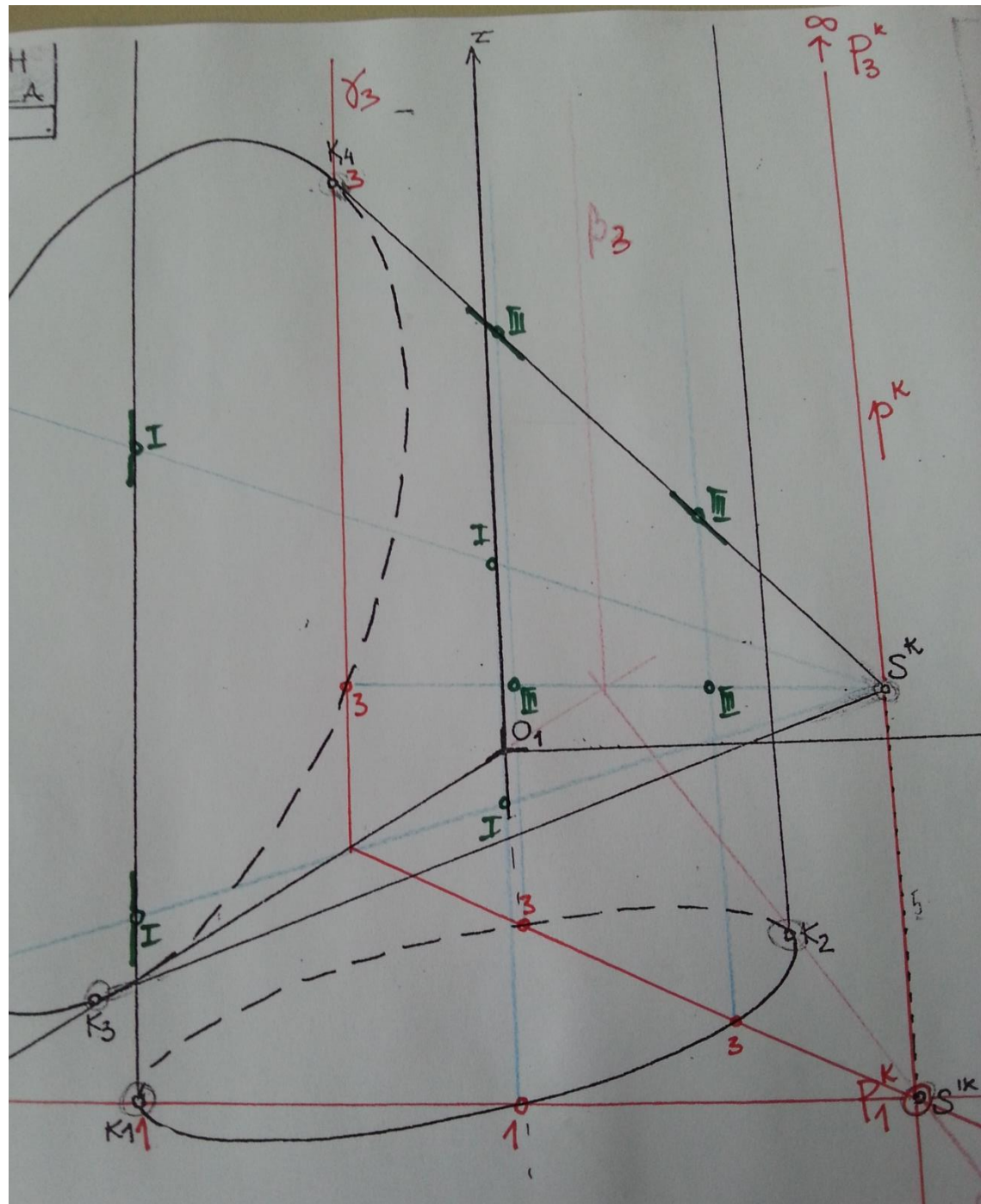

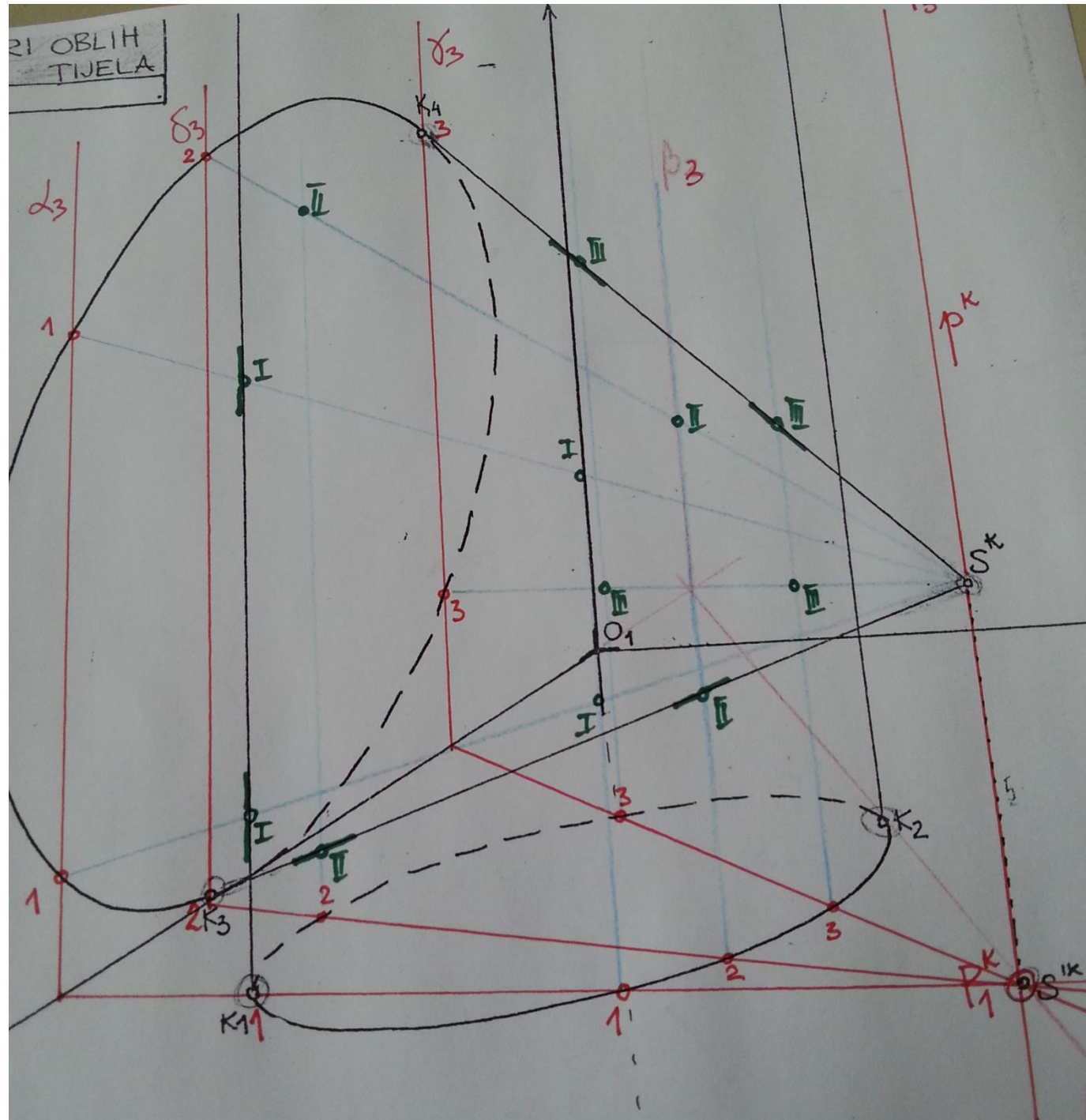

3. Postavljanje pomoćnih ravni:
 a) kroz konturne izvodnice (ravan δ)

i određivanje prodornih tačaka (II) i tangenti na prodornu krivu (u tačkama II i II na konturnoj izvodnici kroz koju smo postavili ravan δ)

BLIH
NELA

3. Postavljanje pomoćnih
ravni:

b) tako da budu dirne ravni
(ravan θ)

i određivanje prodornih
tačkaka (IV) i tangenti na
prodornu krivu (u tačkama
IV i IV); tangente su u pravcu
tijela koje ta dirna ravan
siječe.

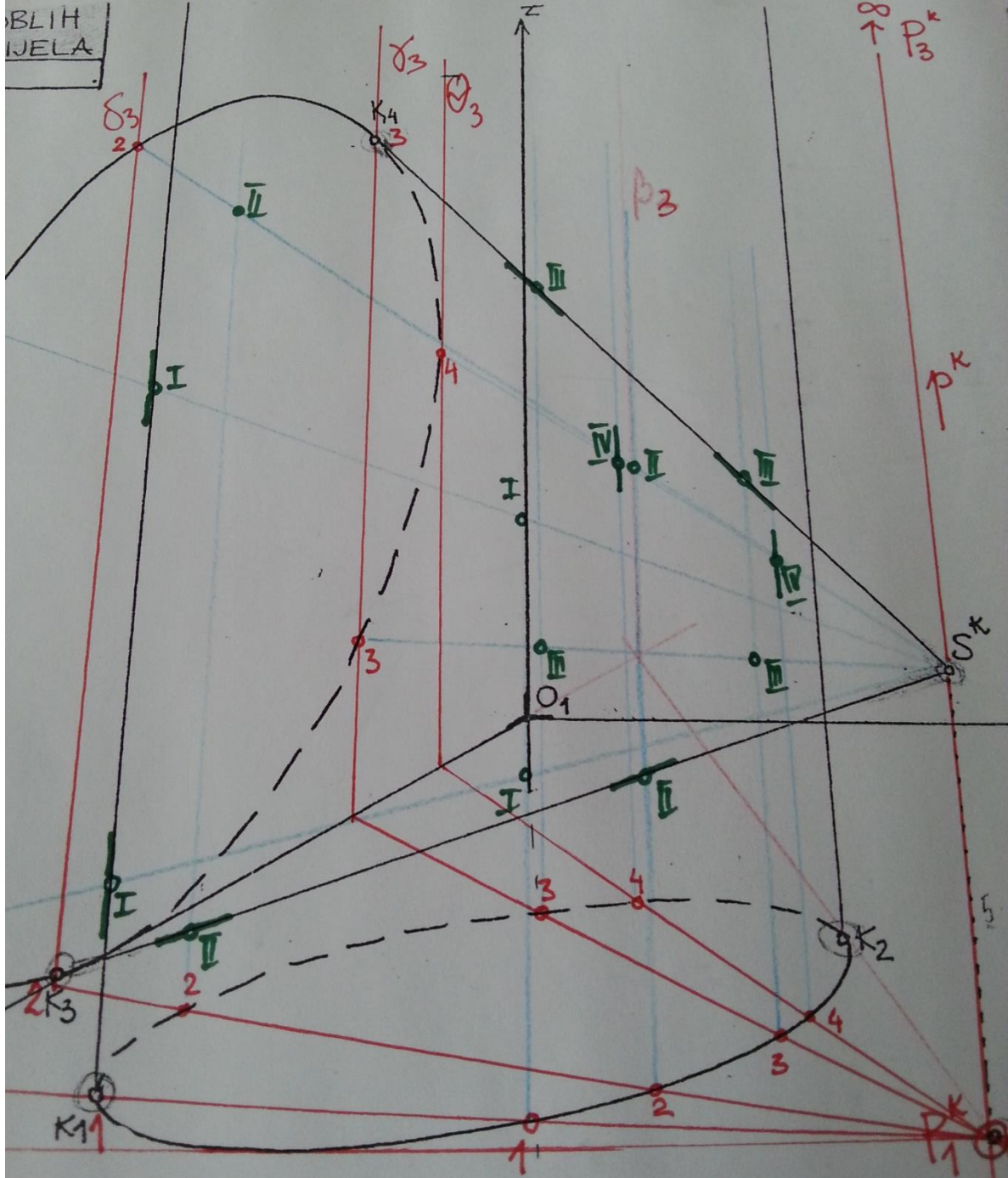

OBRAZLOŽENJE
OBLI
TIJELA

3. Postavljanje pomoćnih
ravni:
b) tako da budu dirne
ravni
(ravan π)

i određivanje prodornih
tačaka (V); to je dvostruka
tačka – kriva kroz nju
prolazi dva puta.

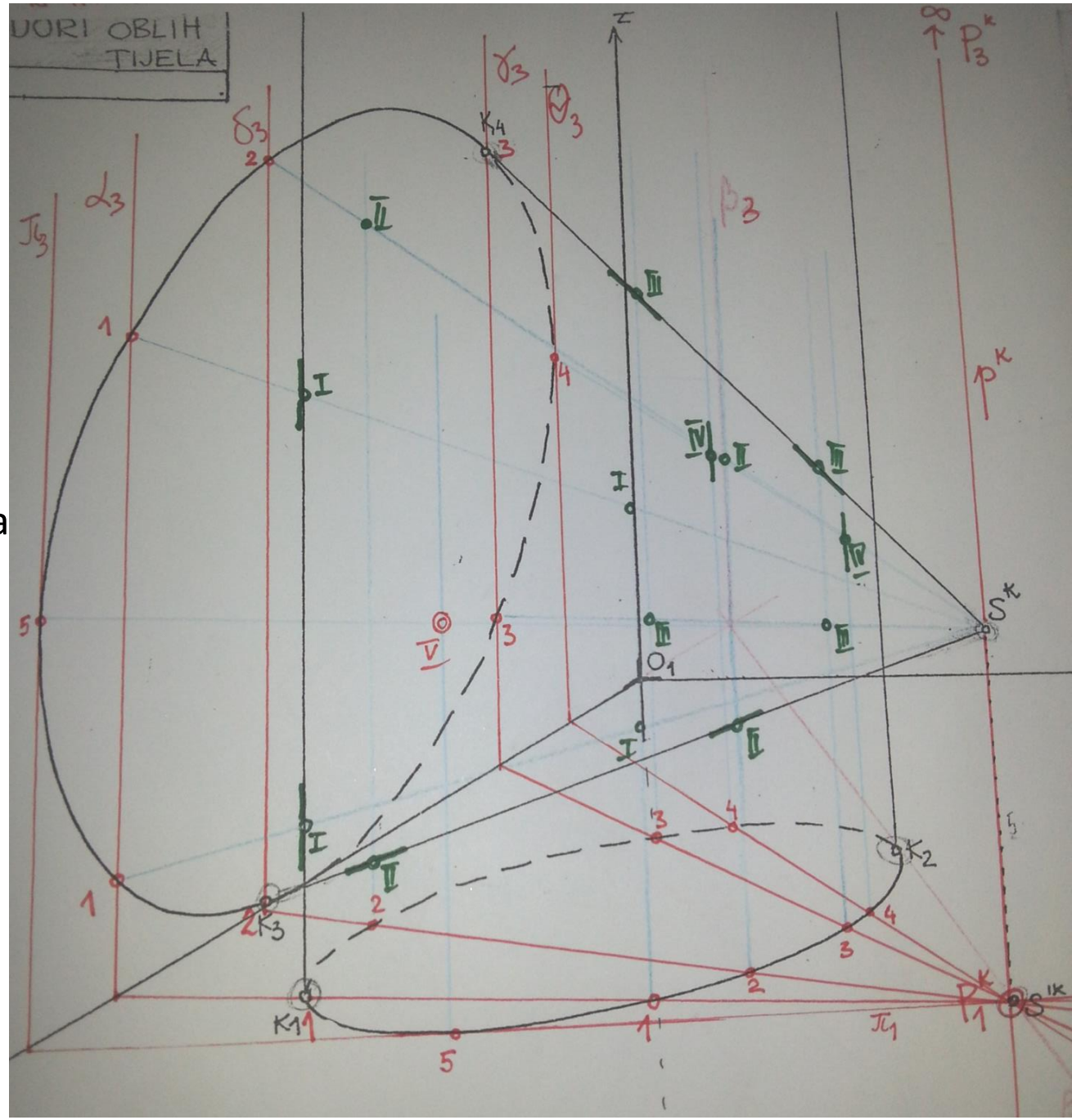

PROBLEMI
TIJELA

3. Postavljanje
pomoćne ravni:
c) kroz najvisočiju
tačku
(ravan 6)

i određivanje
prodornih tačaka (VI);
u njima ne
poznajemo tangente.

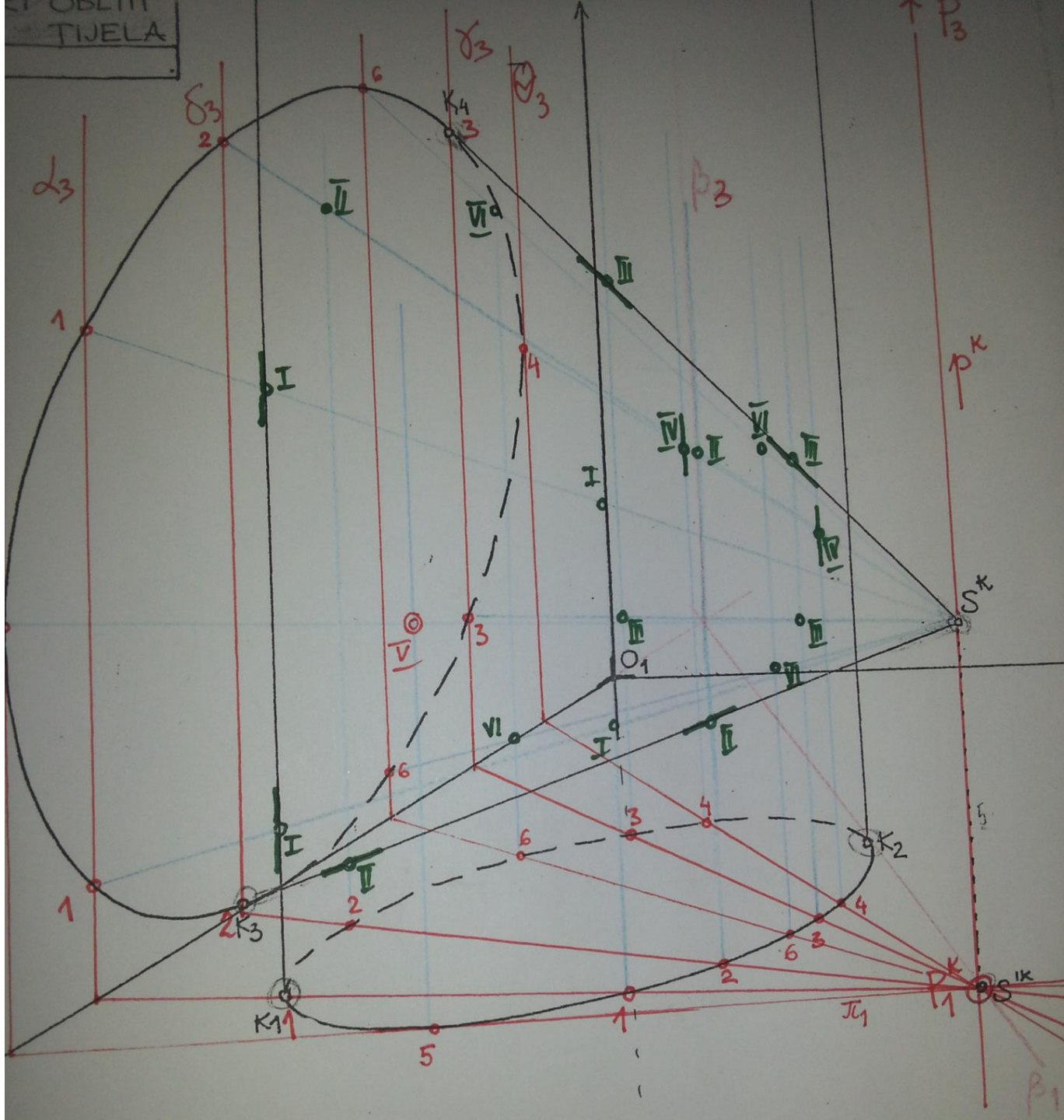

4. Spajanje prodornih tačaka u prodornu krivu, prateći smjer kretanja oko bazisa i poštujući tangente.

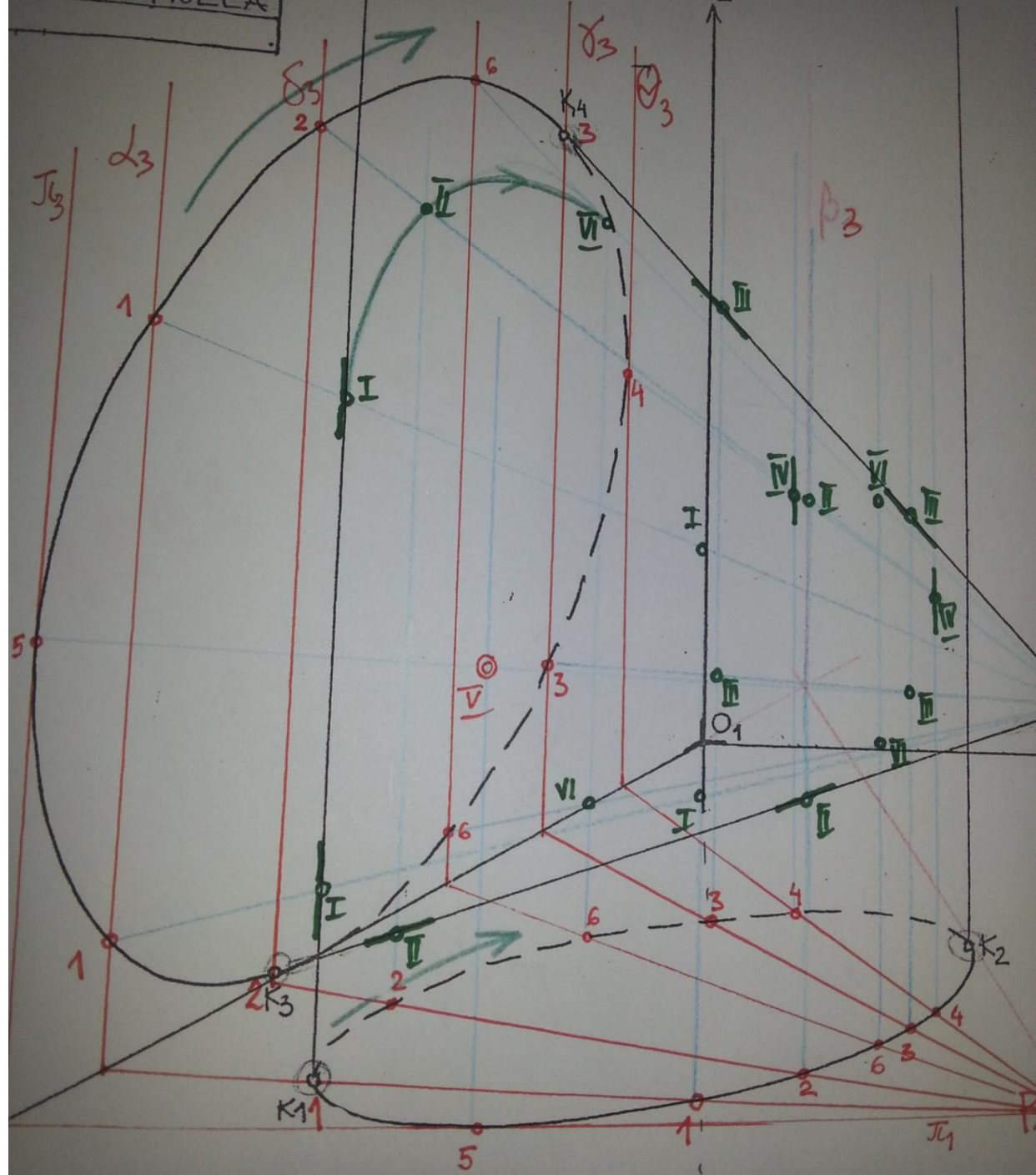

4. Spajanje prodornih tačaka u prodornu krivu, prateći smjer kretanja oko bazisa i poštujući tangente.

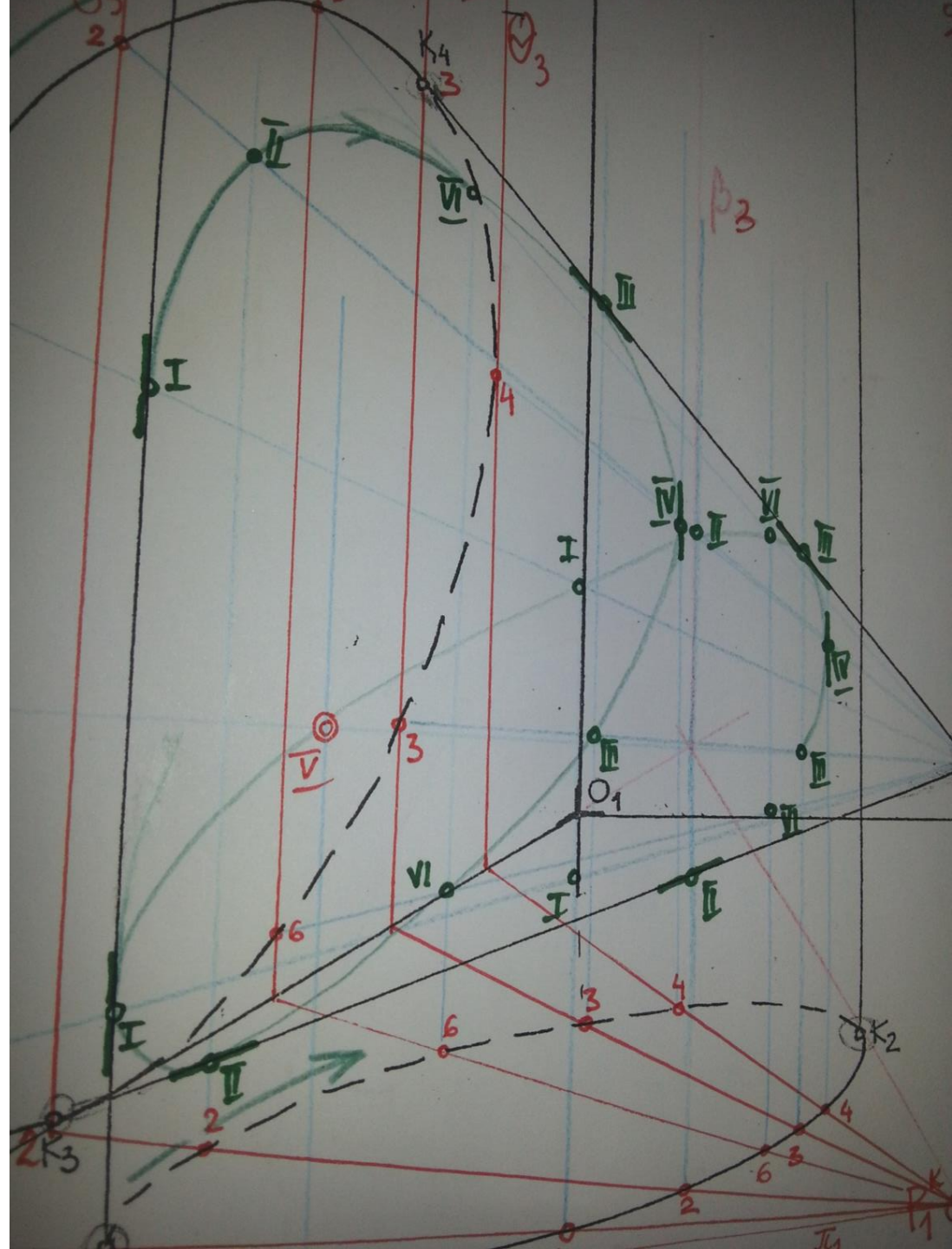

4. Spajanje prodornih tačaka u prodornu krivu, prateći smjer kretanja oko bazisa i poštujući tangente.

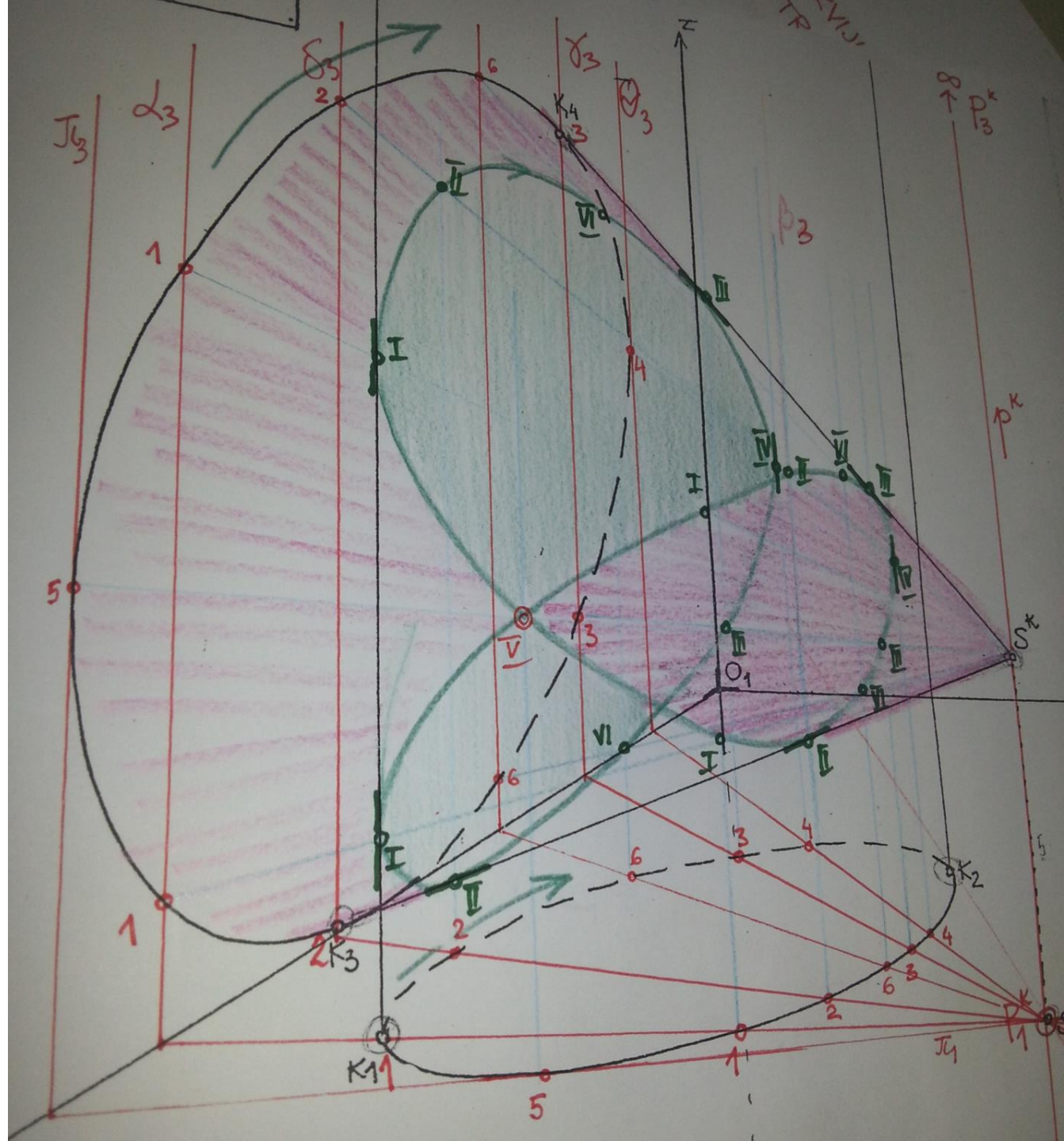

Hiperbolički paraboloid

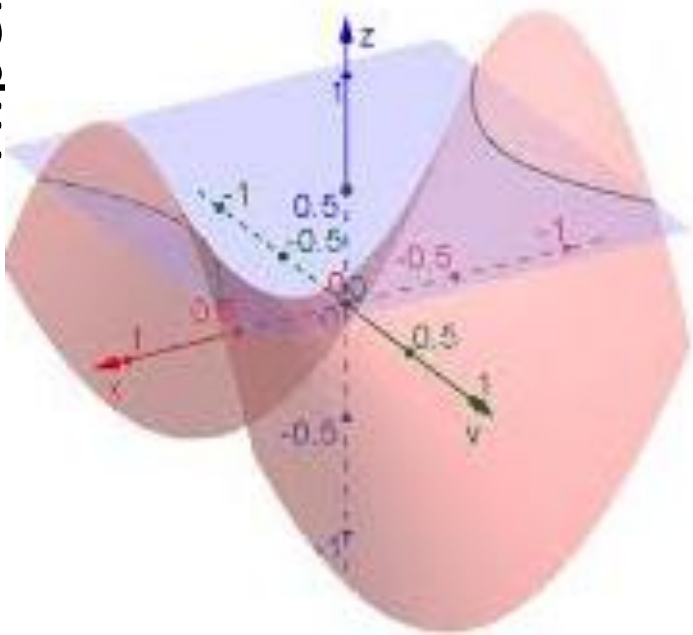
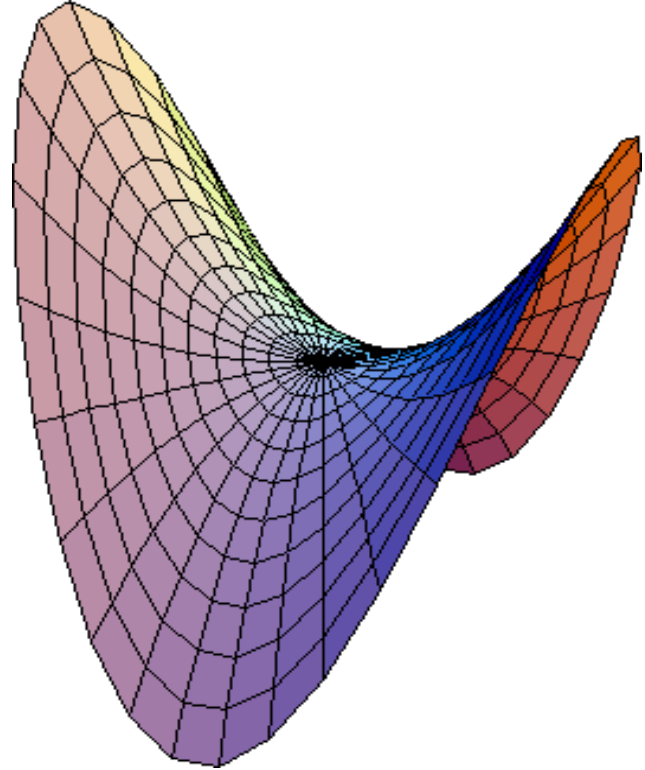







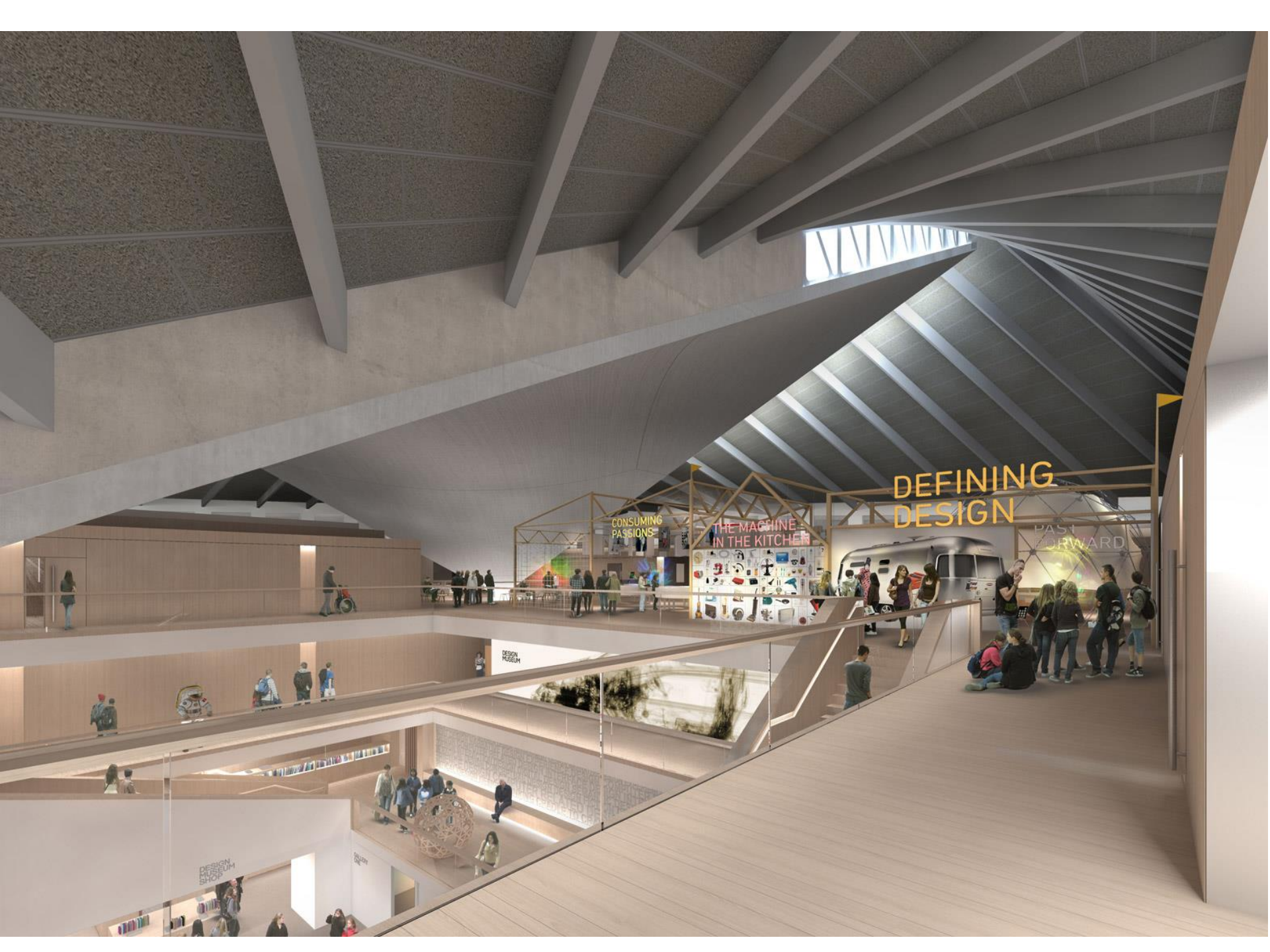

DEFINING DESIGN

CONSUMING PASSIONS

THE MACHINE IN THE KITCHEN

PAST FORWARD

DESIGN MUSEUM

DESIGN MUSEUM SHOP

Fig 5

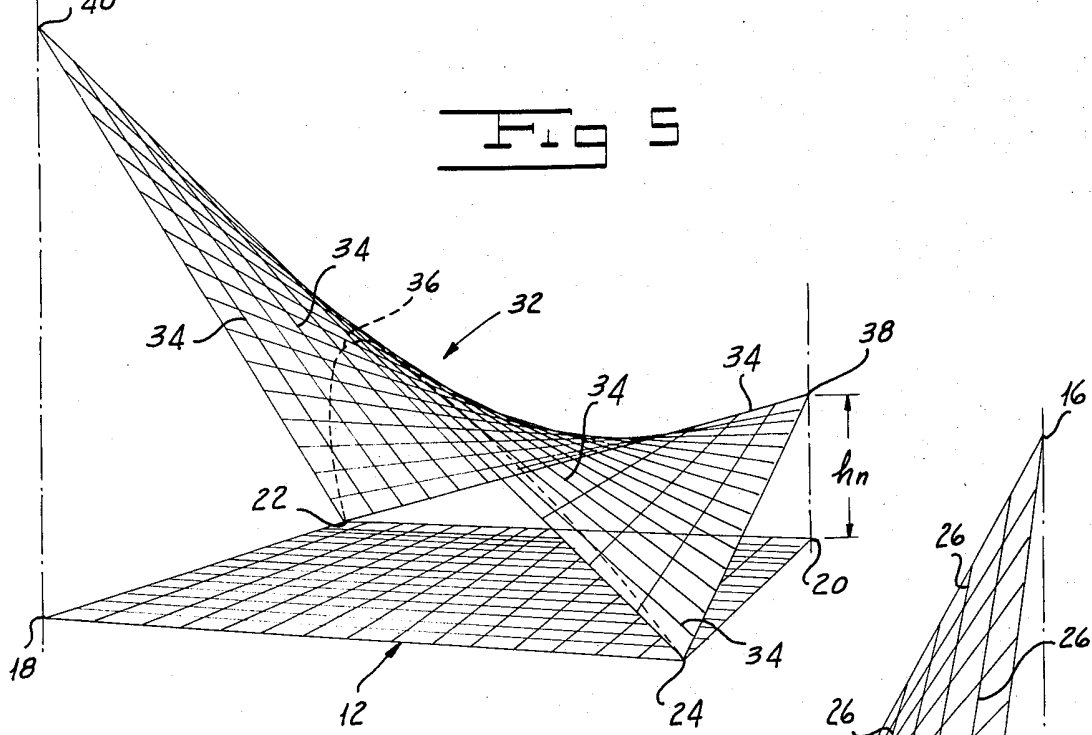
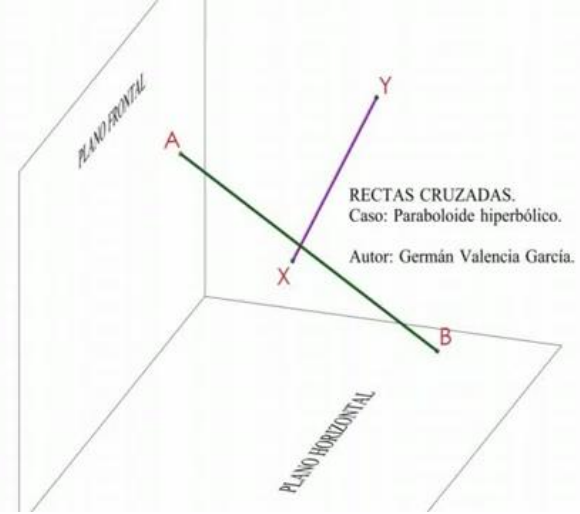
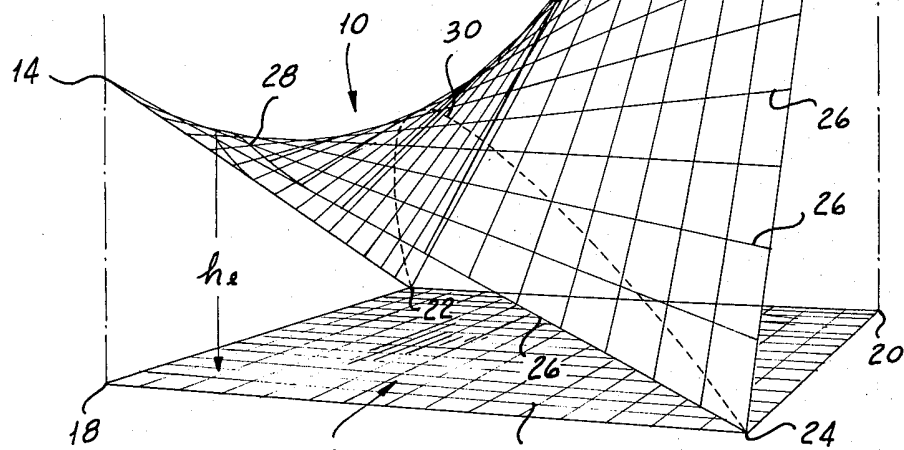
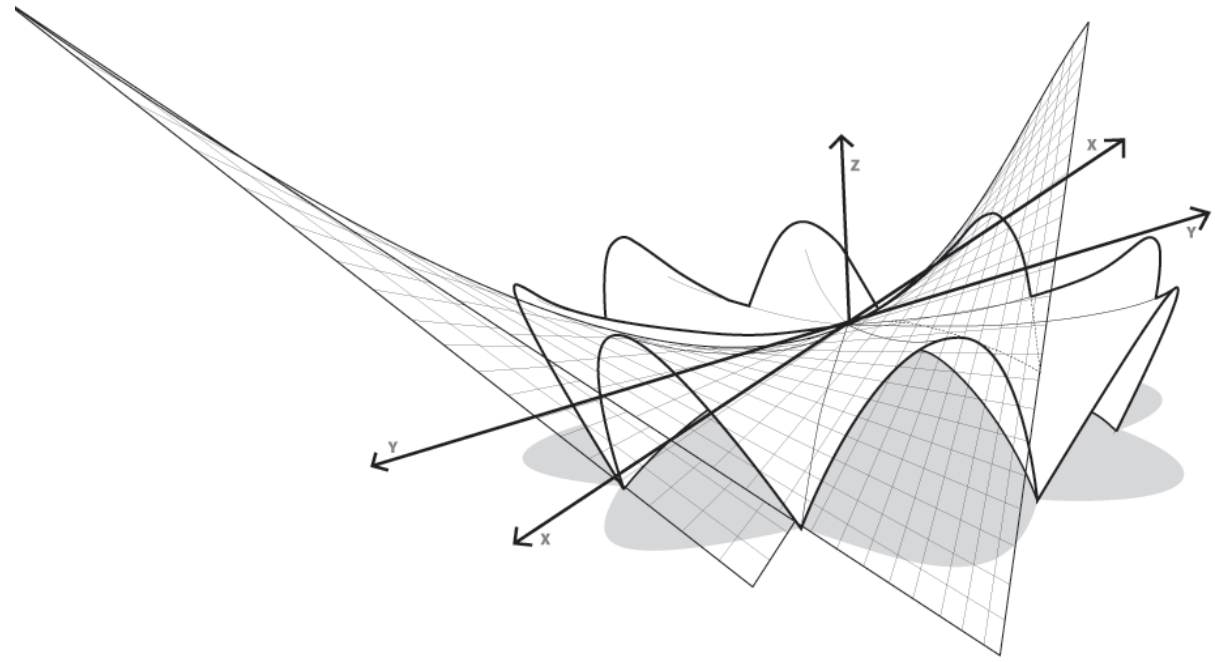
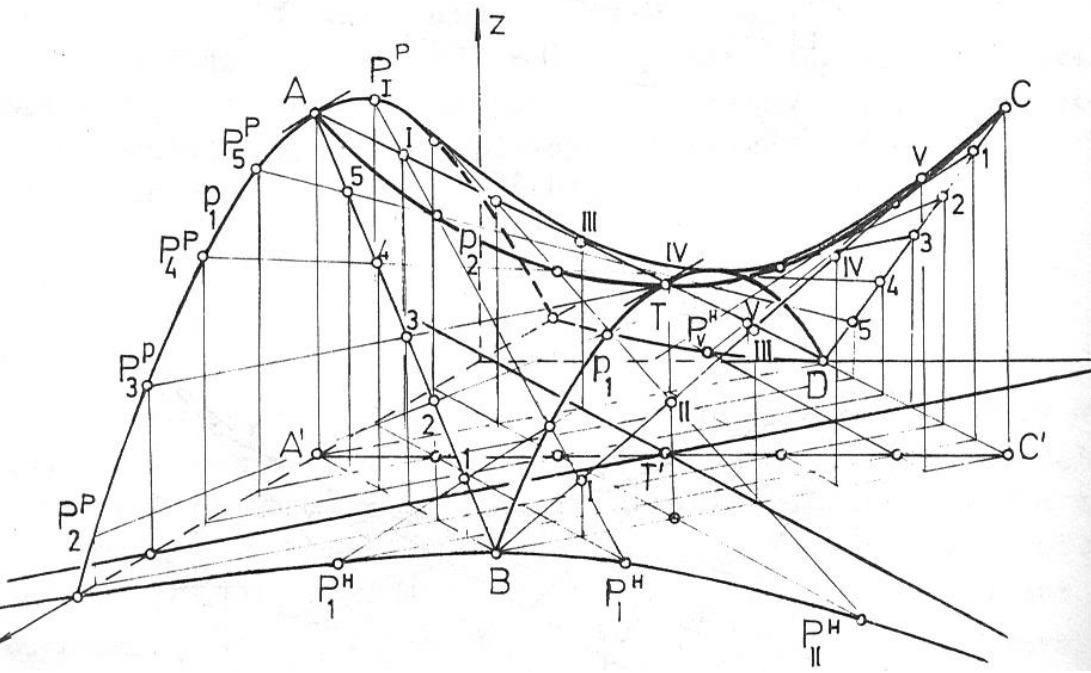
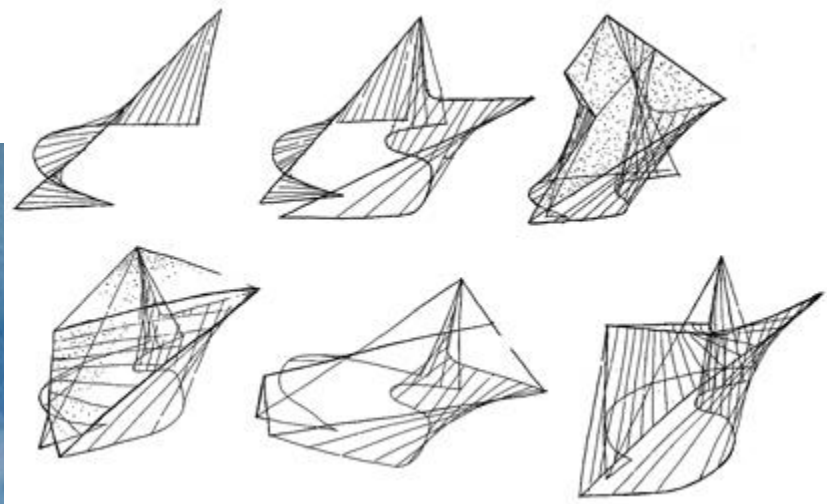
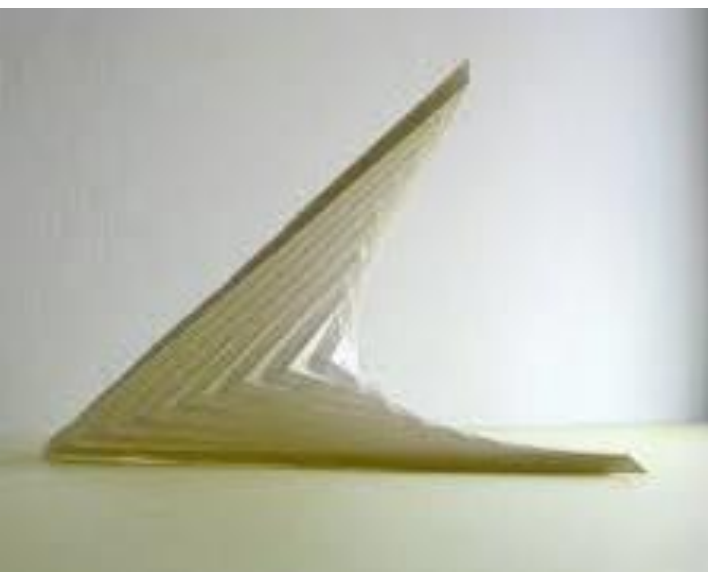

Fig 4









An Exhibit on the Work of Félix Candela

Paraboloid rotacioni

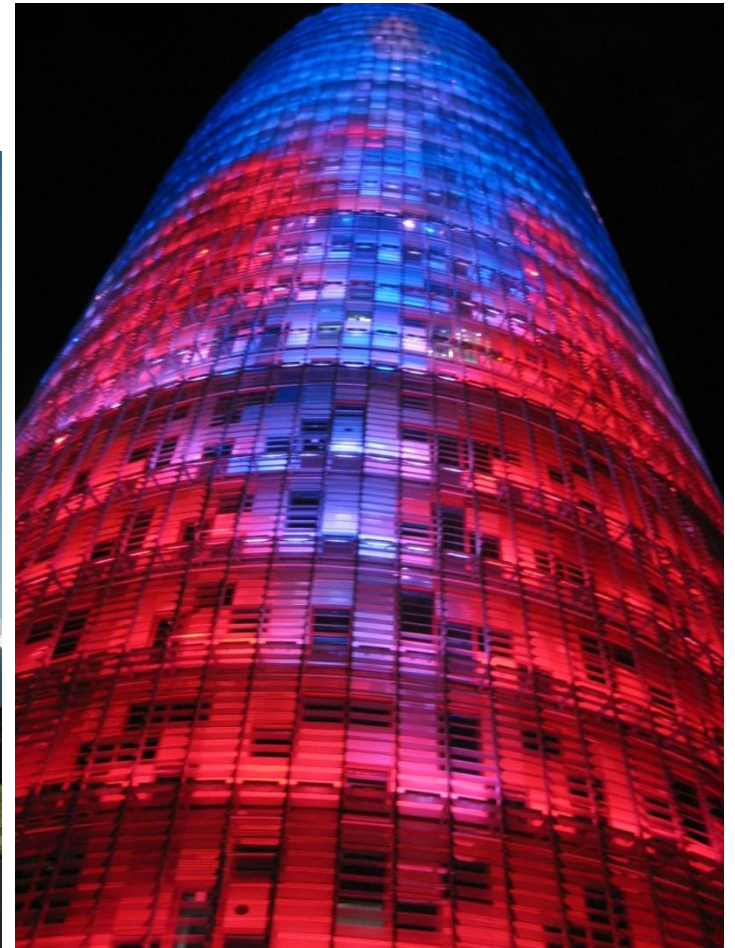
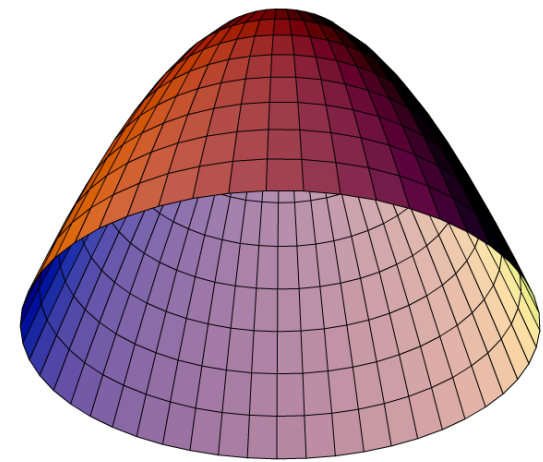

Hiperboloid jednograni (rotacioni)

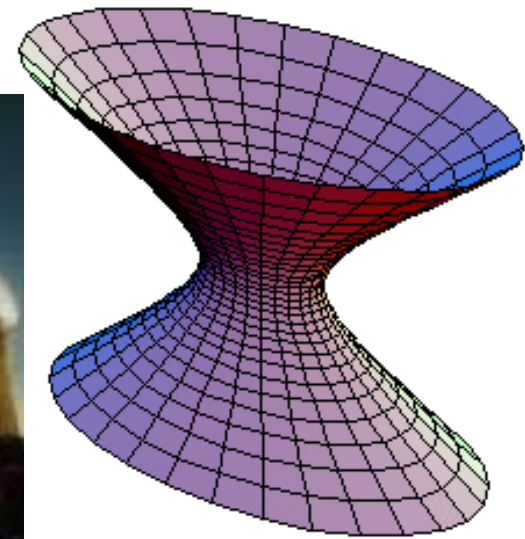

HIPERBOLOIDE DE REVOLUCIÓN

Autor:
Germán Valencia García.



VISTA HORIZONTAL

www.photaki.com

www.photaki.com

www.photaki.com

www.photaki.com

www.photaki.com

www.photaki.com

www.photaki.com

www.photaki.com

www.photaki.com

www.photaki.com

www.photaki.com

www.photaki.com



Photomatrix

Photomatrix

Photomatrix

W.H. Smith

Zavojnica (helikoida)

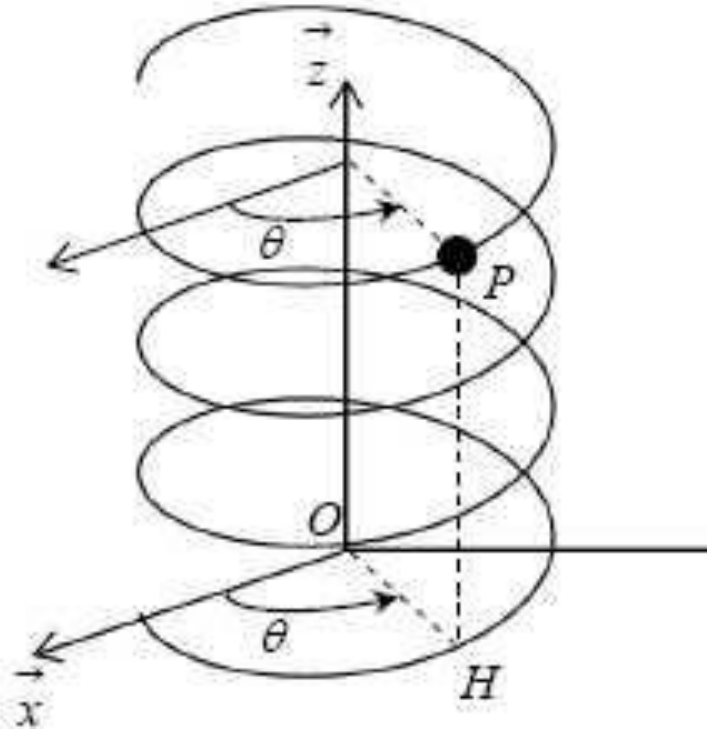

Helikoid

HELICOIDE RECTO.

Autor:
Germán Valencia García.

C1



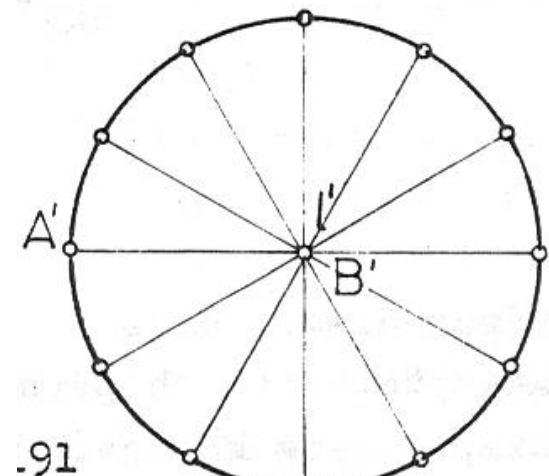
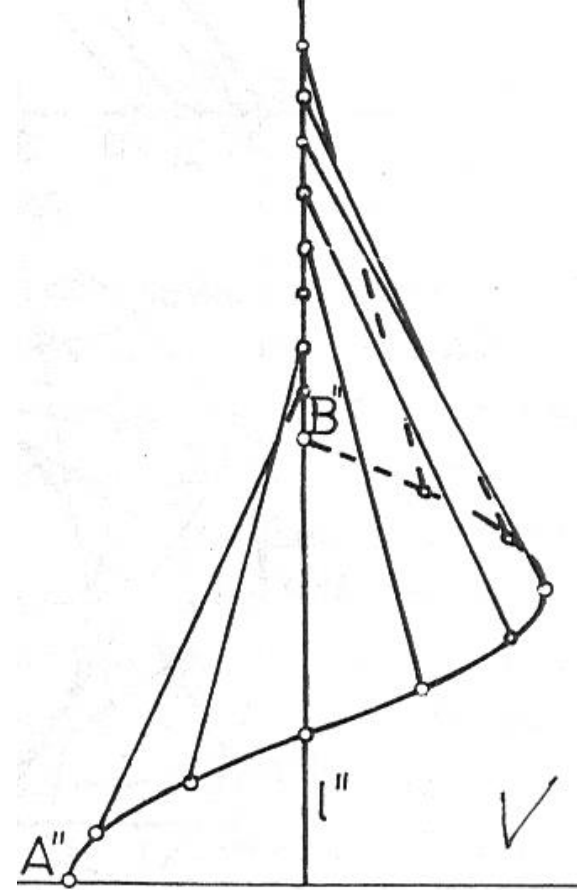

Konoid

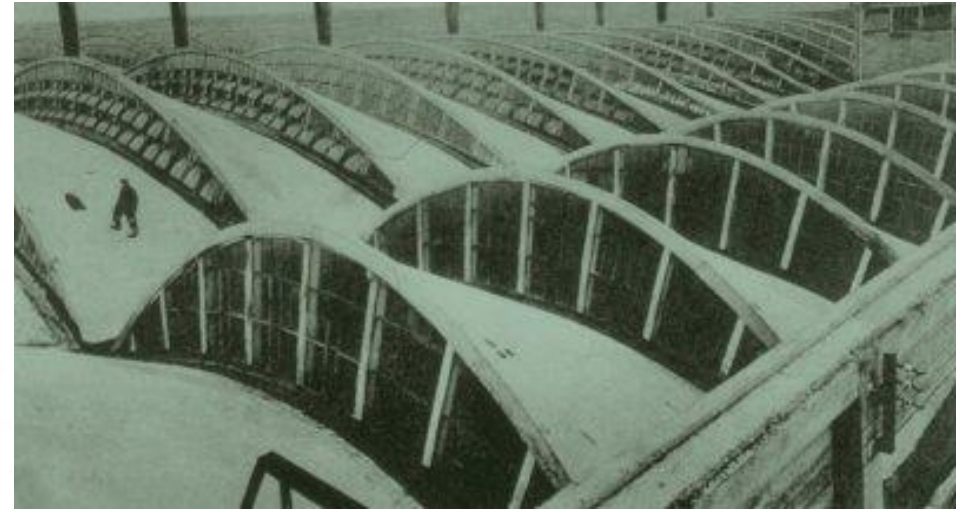
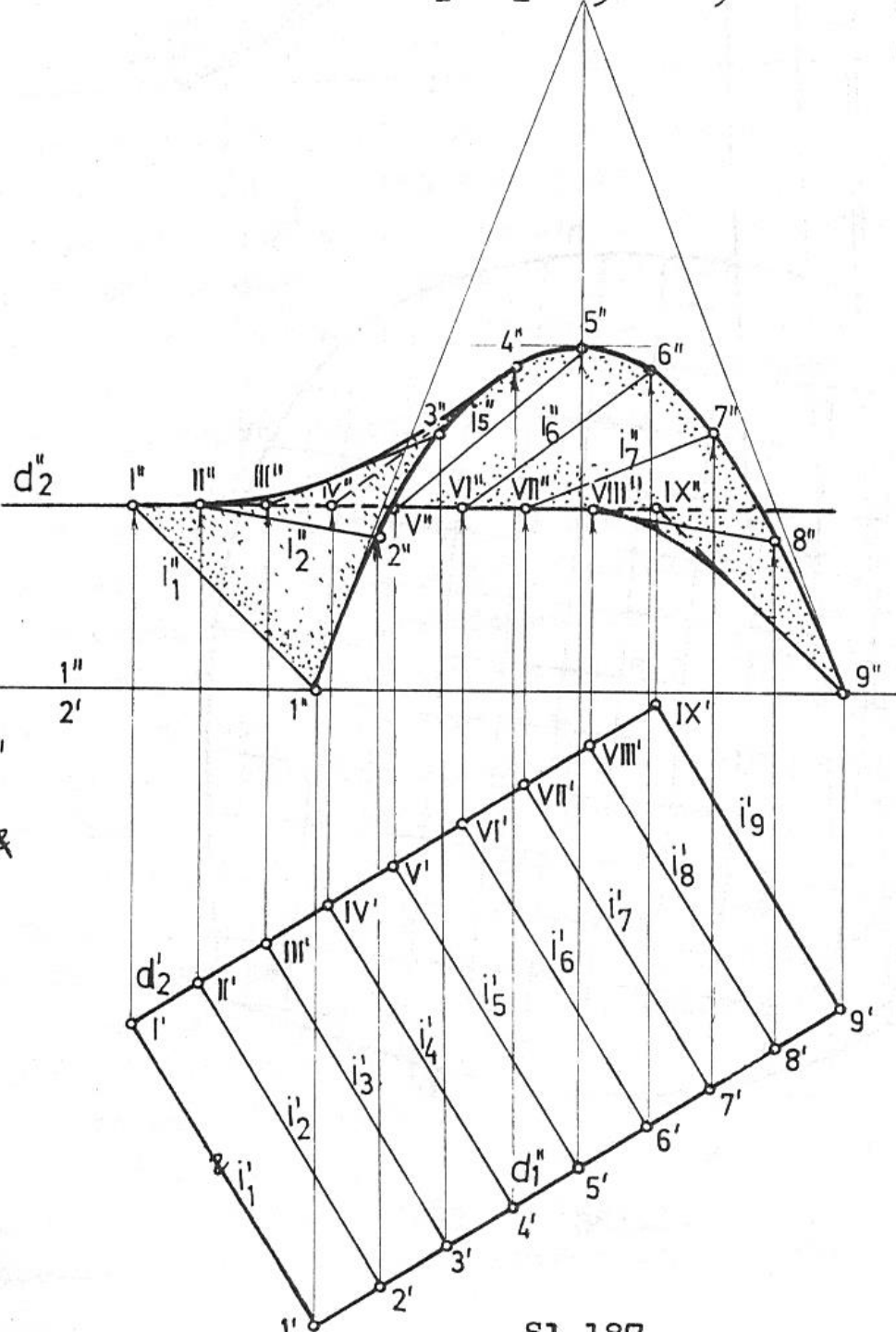

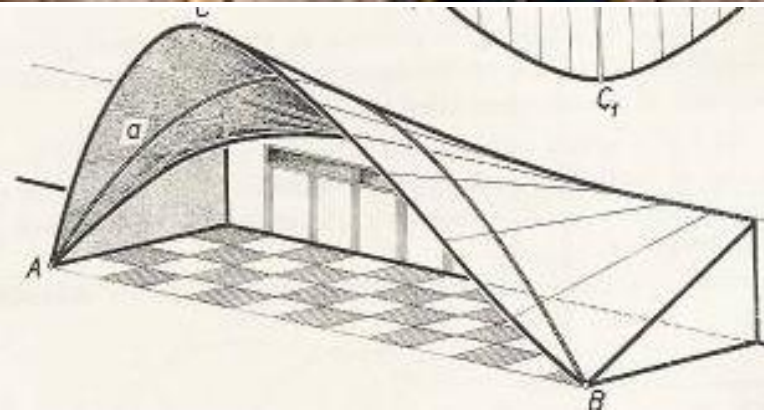

Cilindroid

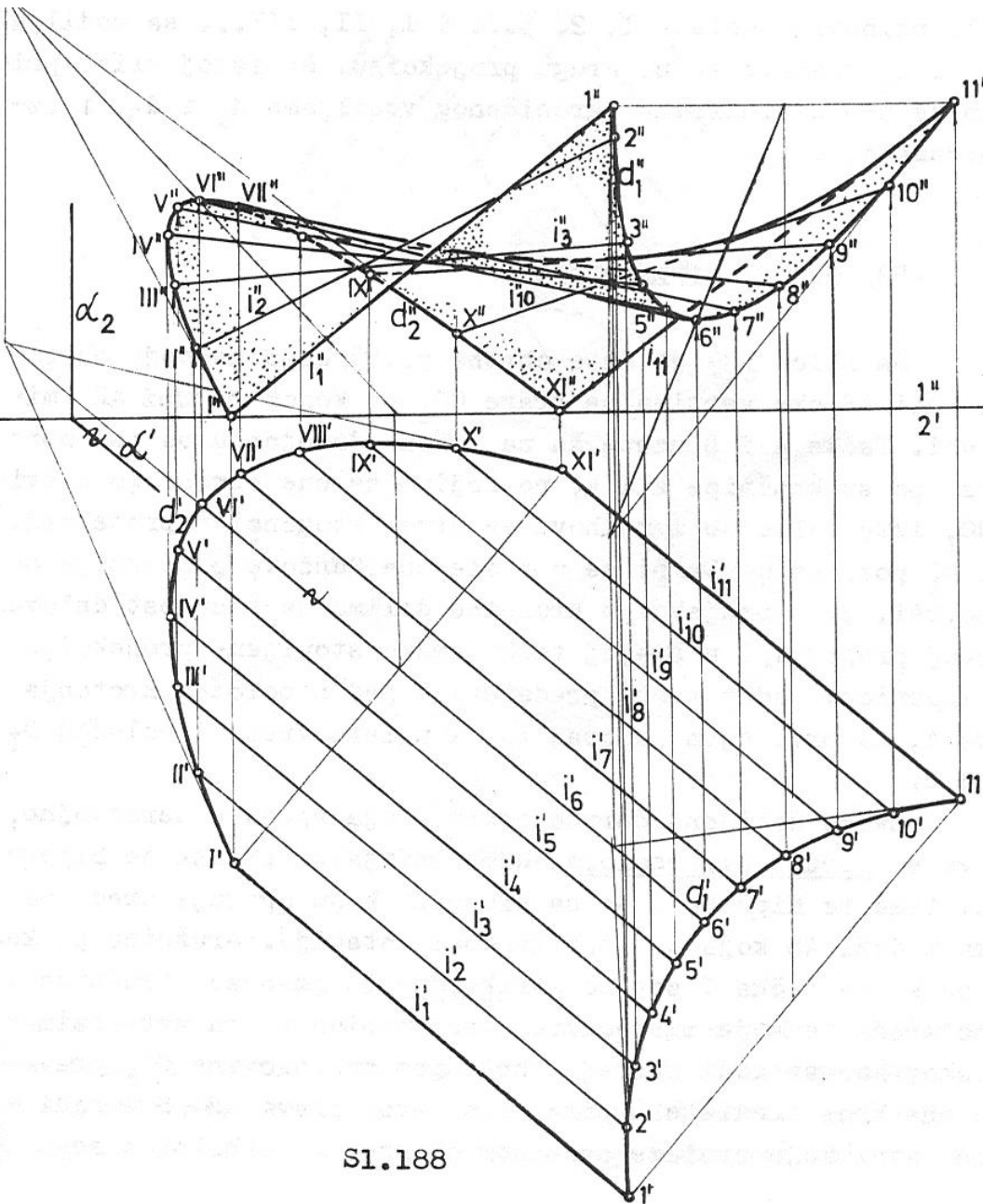

EL CONOIDE RECTO - THE RIGHT CONOID. 1

Autor: Germán Valencia García.
Arquitecto.

E-mail: gervalengar_67@hotmail.com



Još neke površi...

1

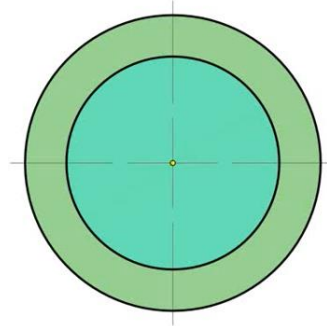

LA TORRE DEL CUERNO DE VACA
Arquitecto: Germán Valencia García.
Arquitecto.



Hiperbolički cilindar

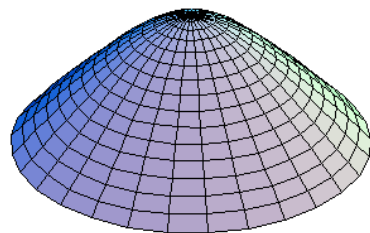
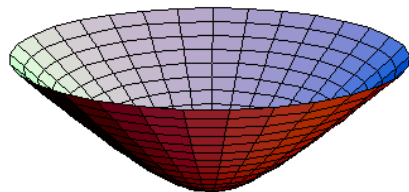
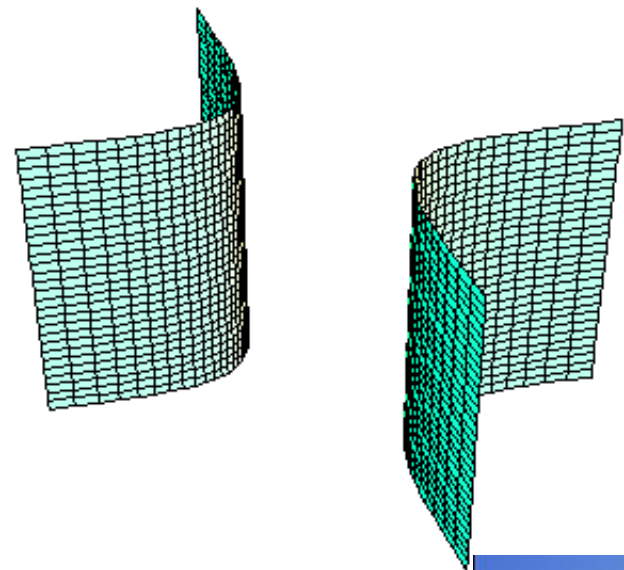

... i njihove kombinacije

Parabolički cilindar

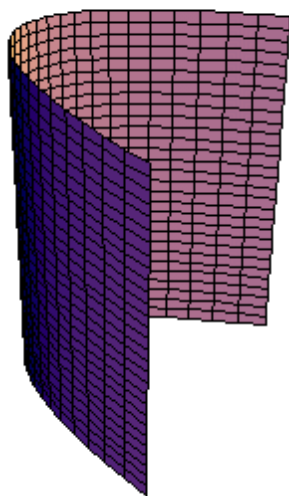

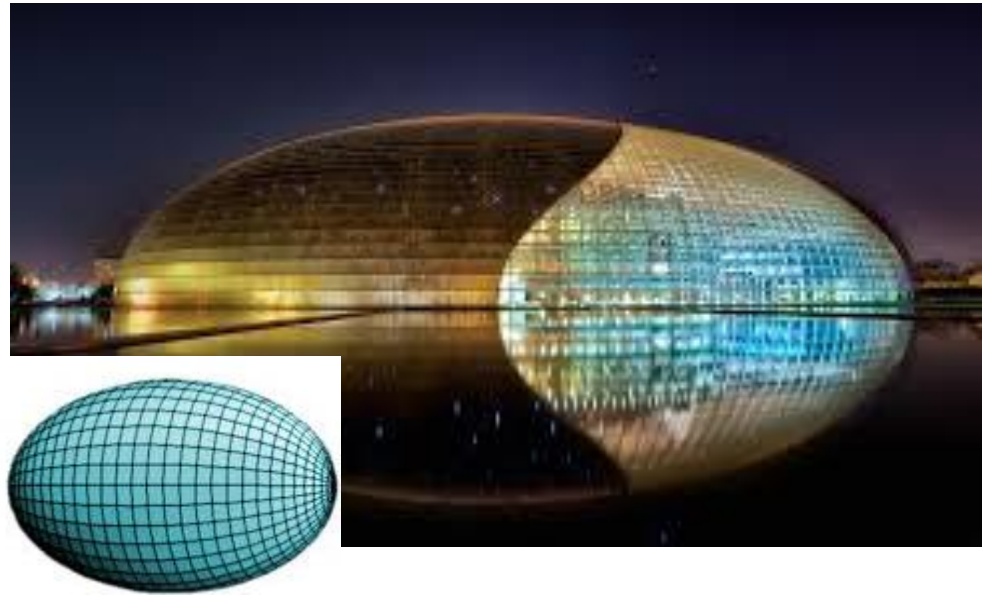

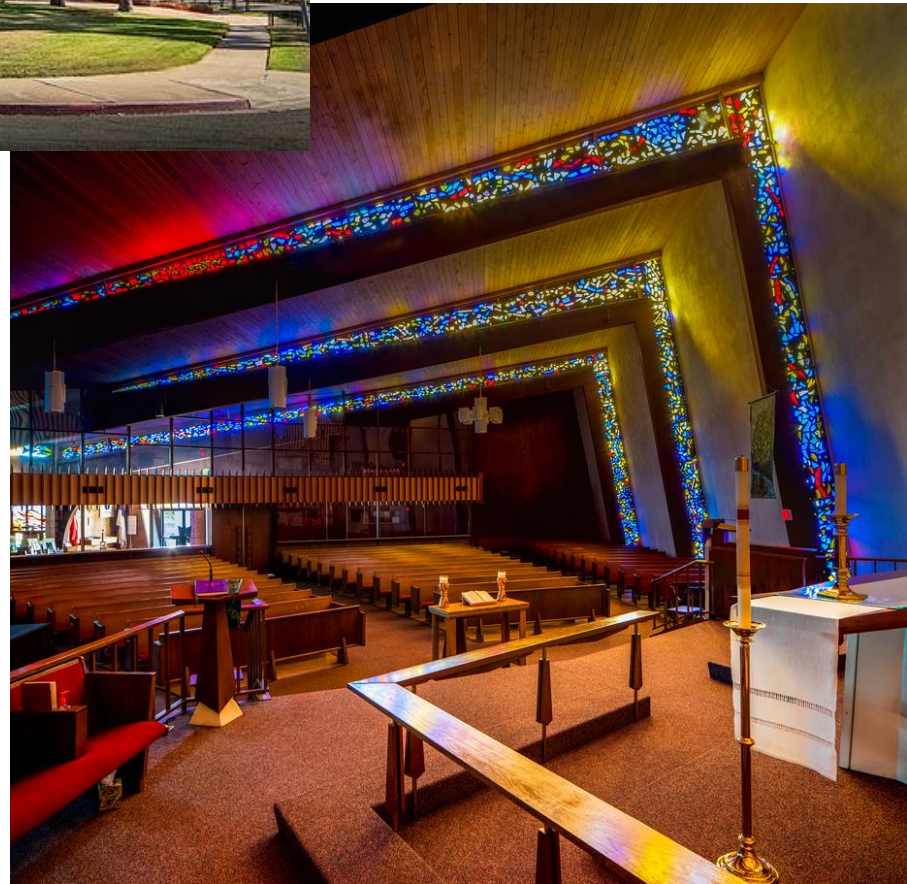

Kako predstaviti teren na crtežu?

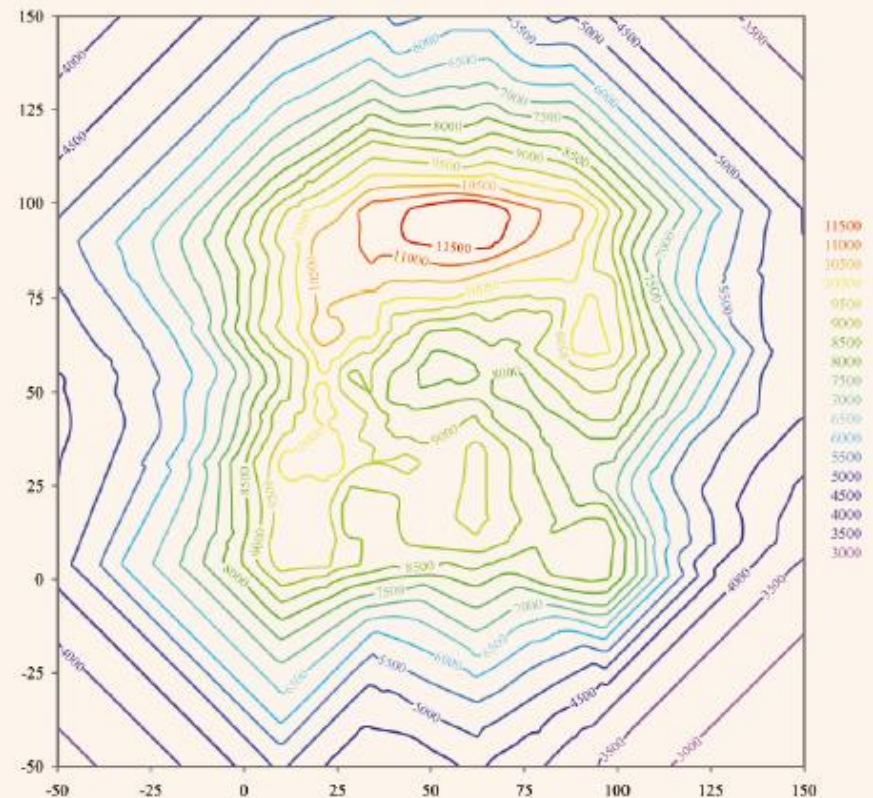
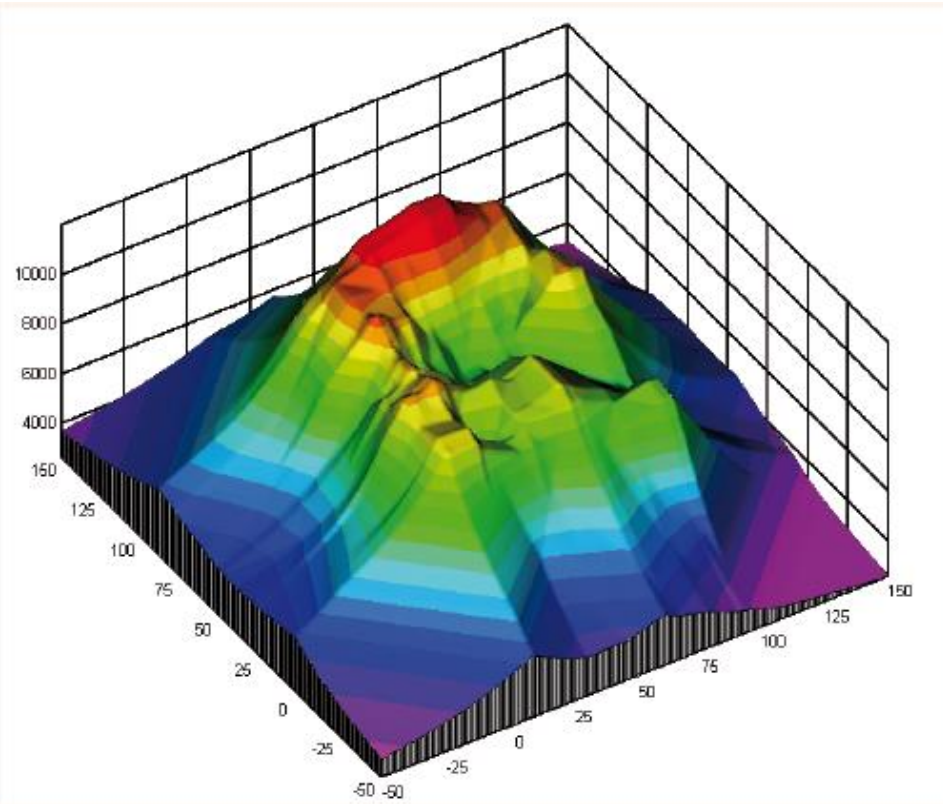

$h_C = 0\text{m}$
 $h_A = 3\text{m}$
 $h_B = -4,2\text{m}$

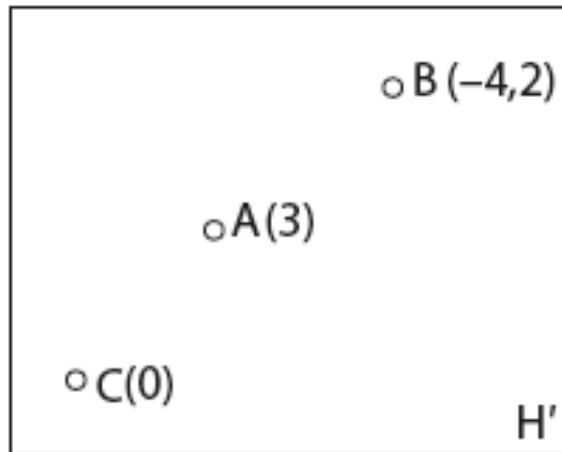
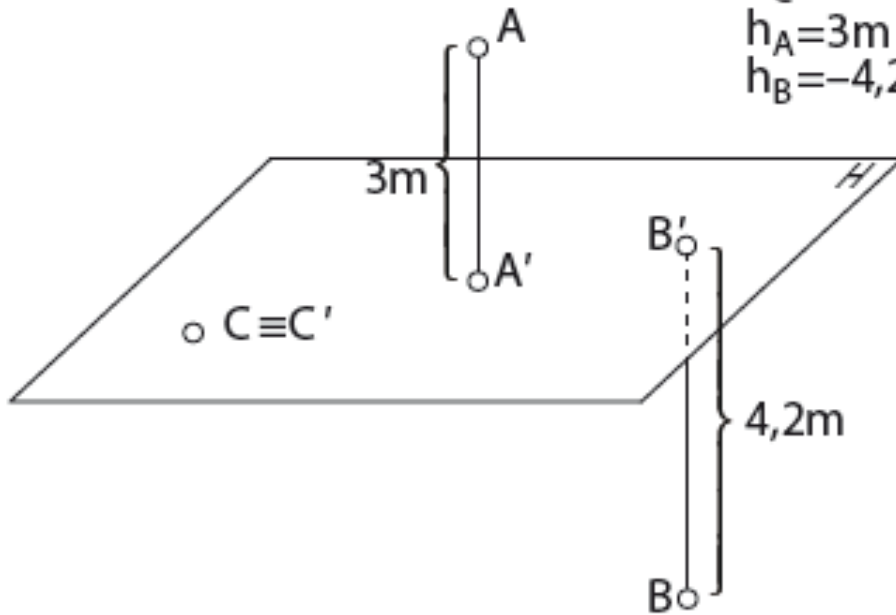

Tačka u kotiranoj projekciji

a)

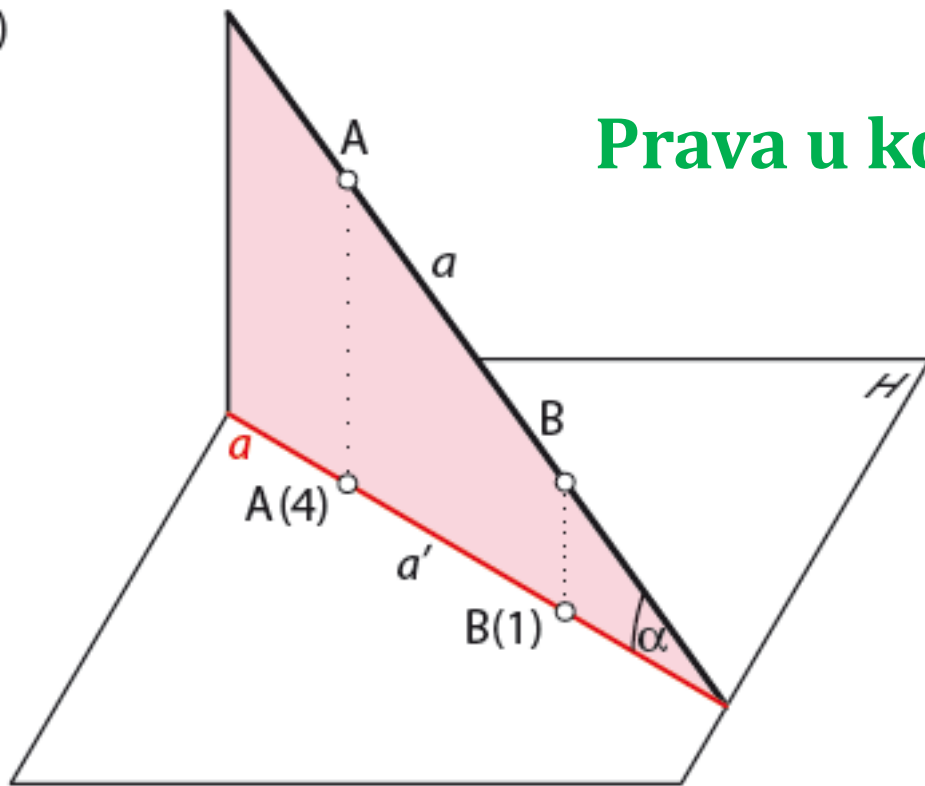

Prava u kotiranoj projekciji

b)

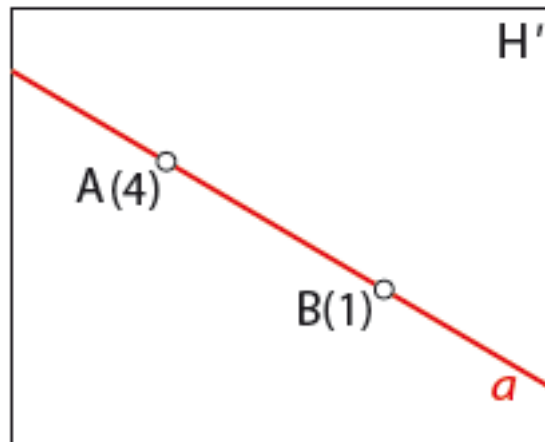

Prava veličina duži

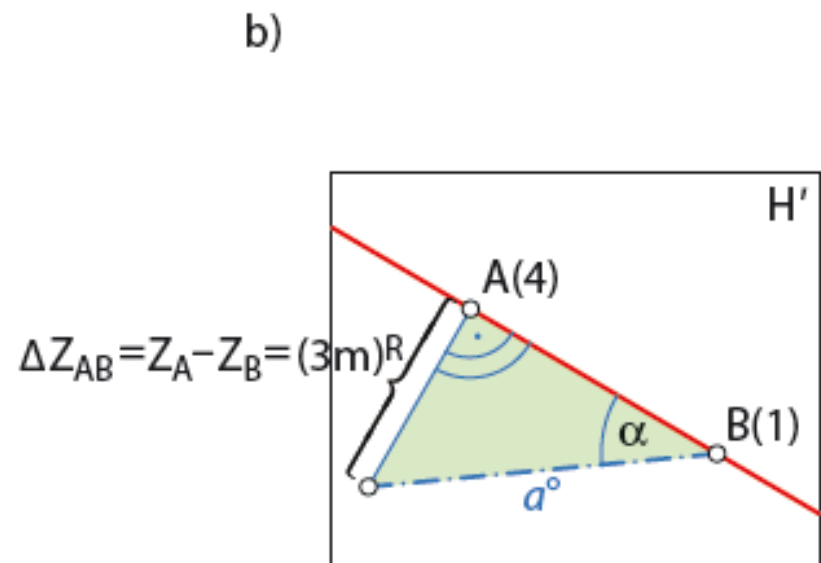
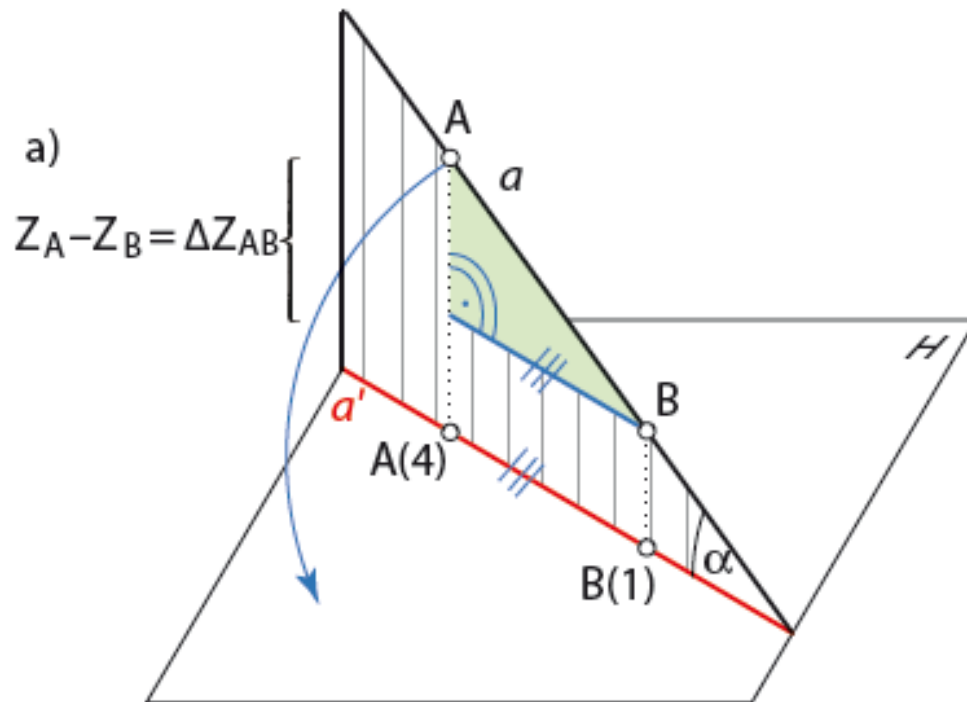

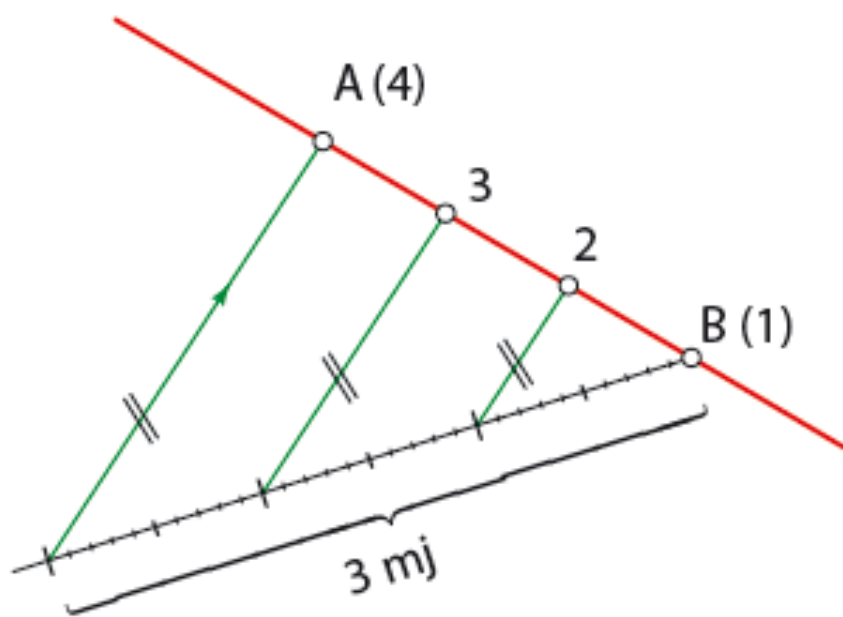

Graduisanje prave

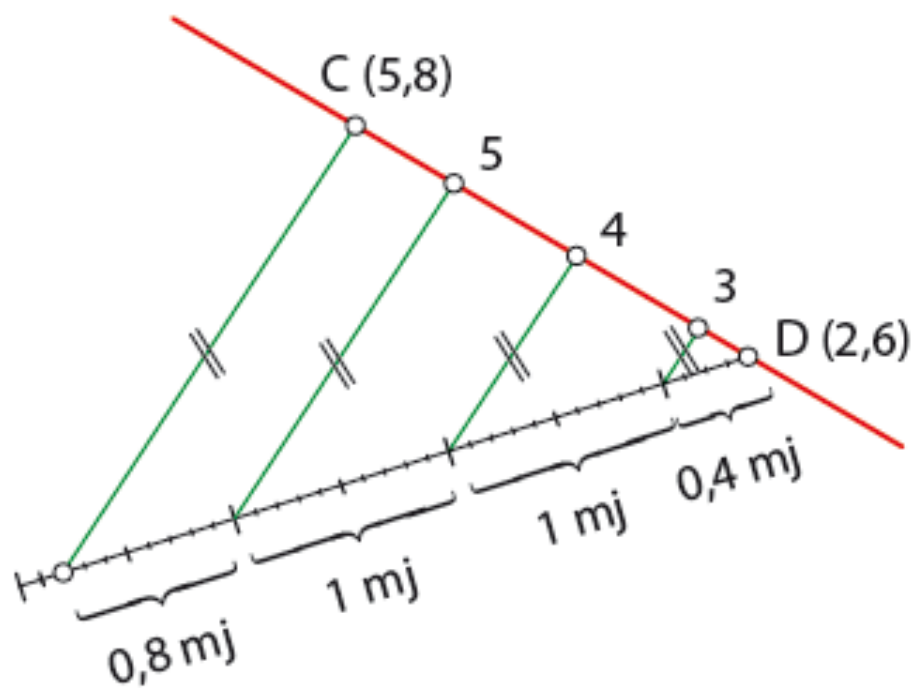

INTERVAL I PAD PRAVE

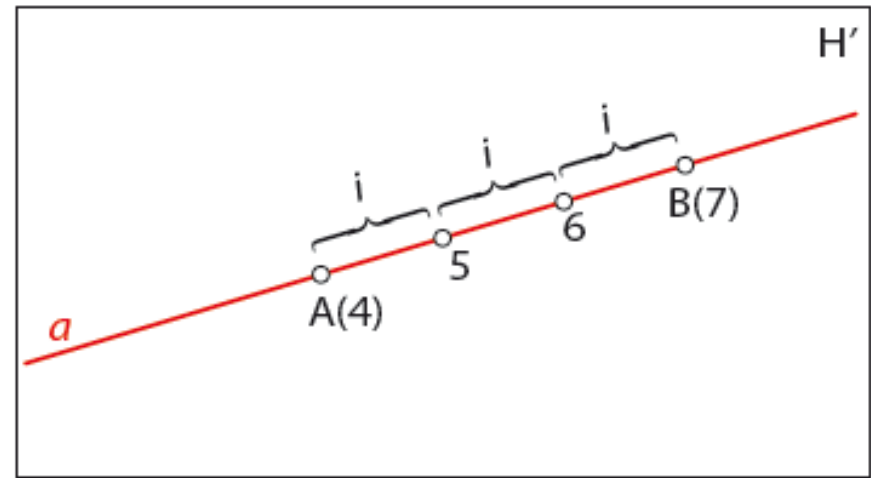

a)

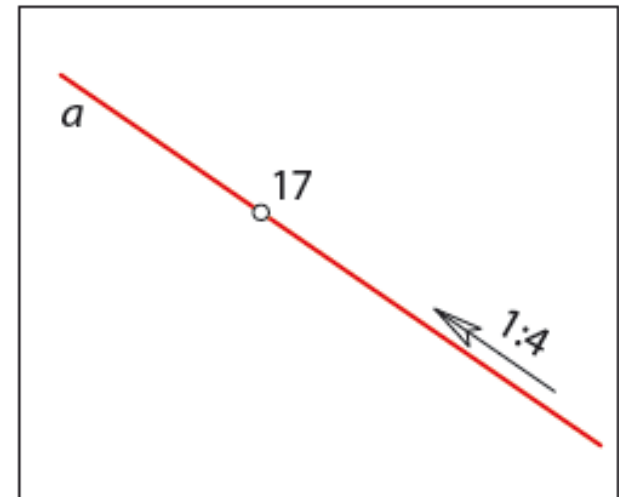
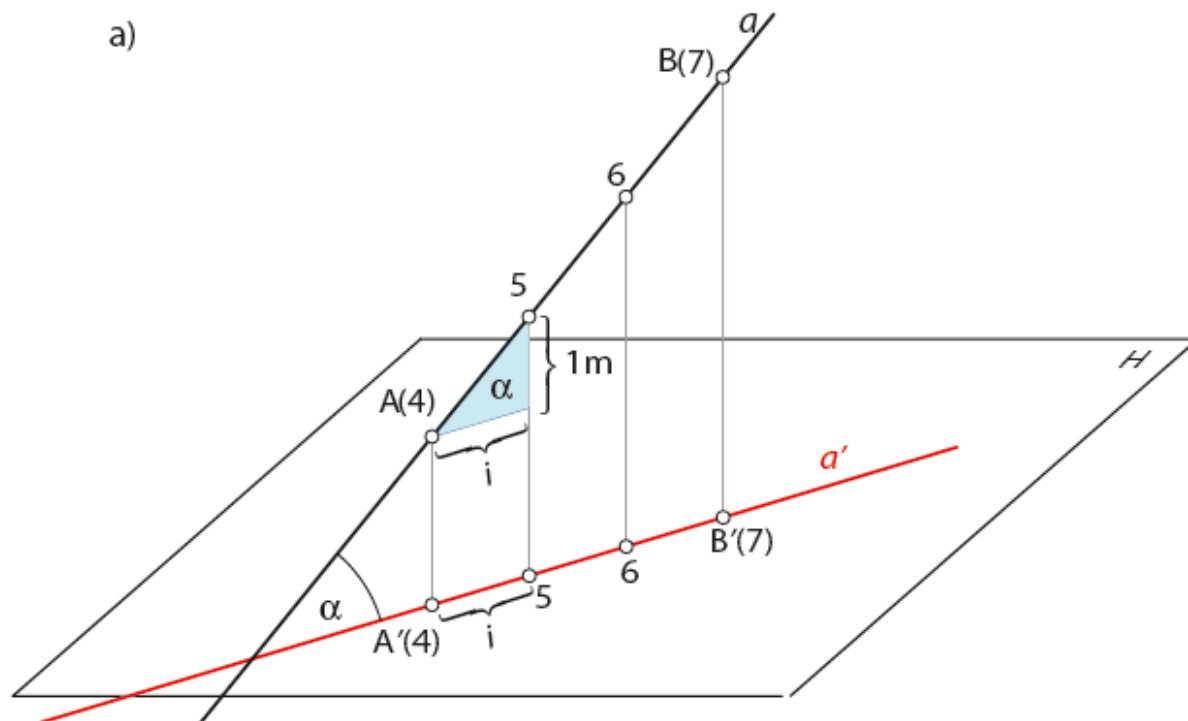

Međusobni odnos pravih u prostoru

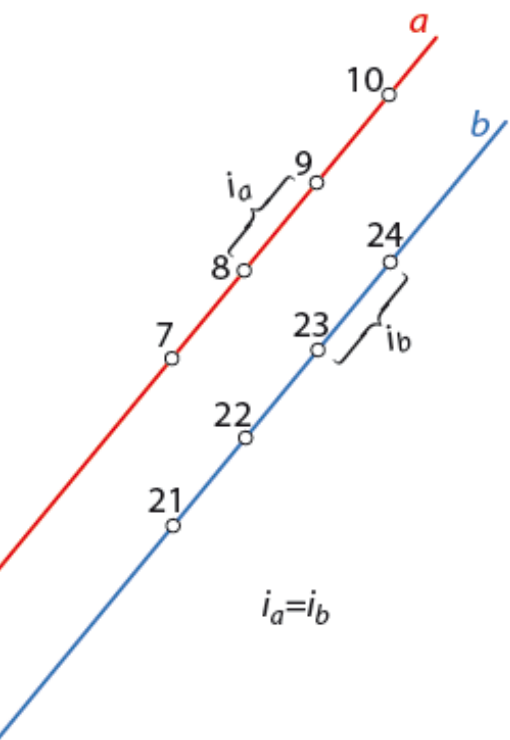

b)

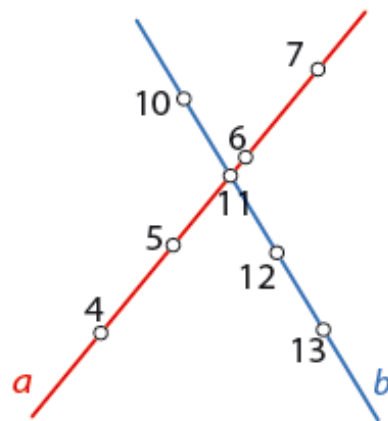

c)

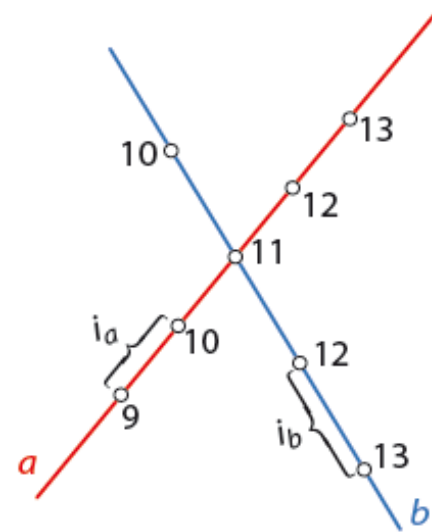

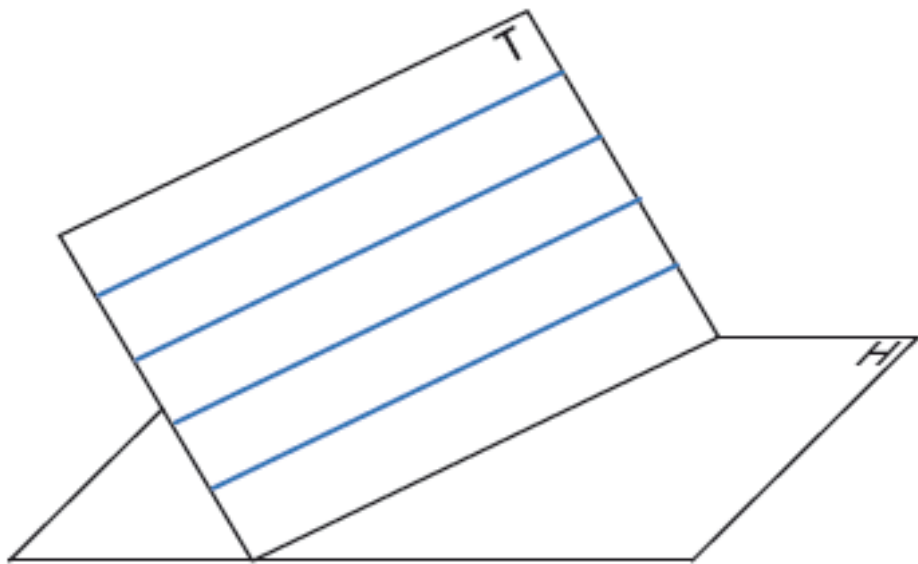

Ravan u kotiranoj projekciji

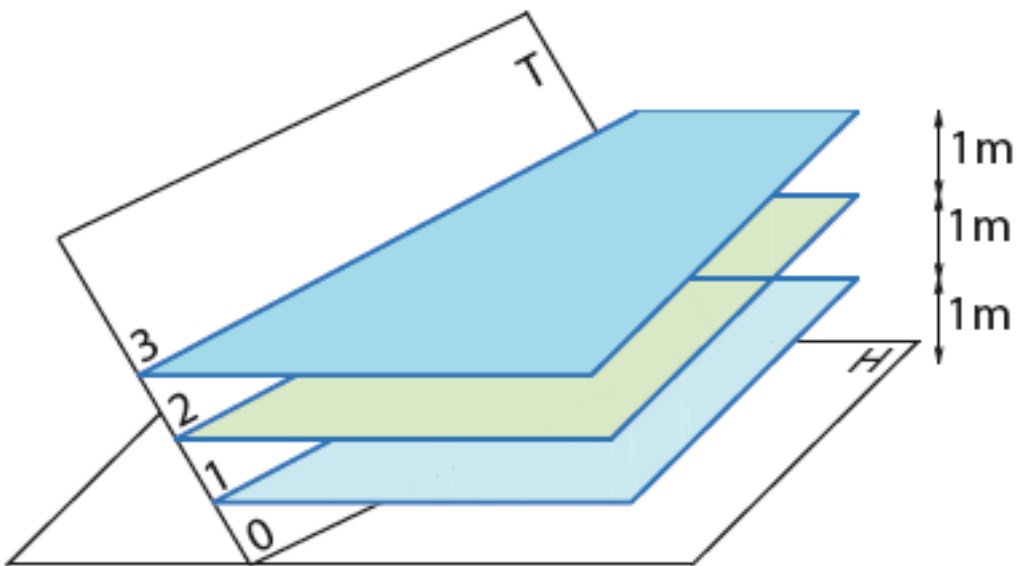

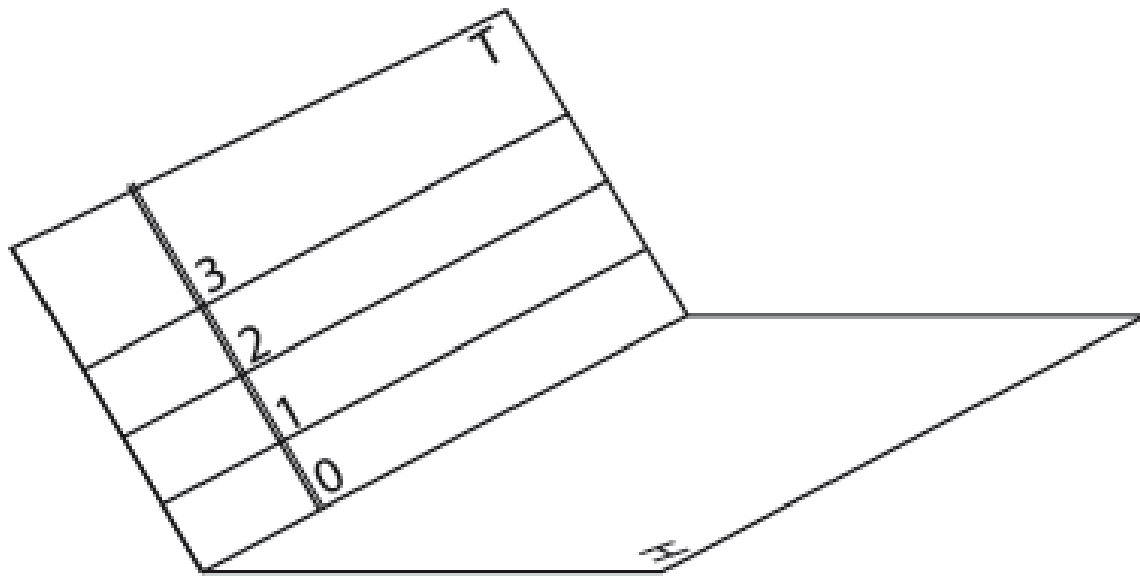

Izohipse
i nagibnica
ravni

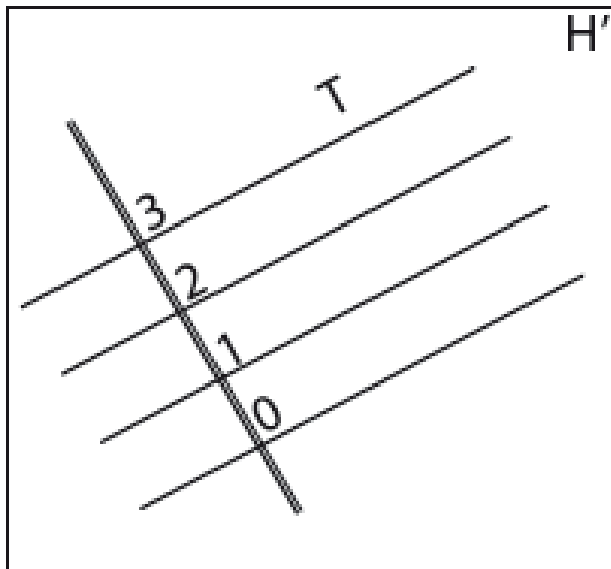

Ravan određena samo jednom pravom - nagibnicom

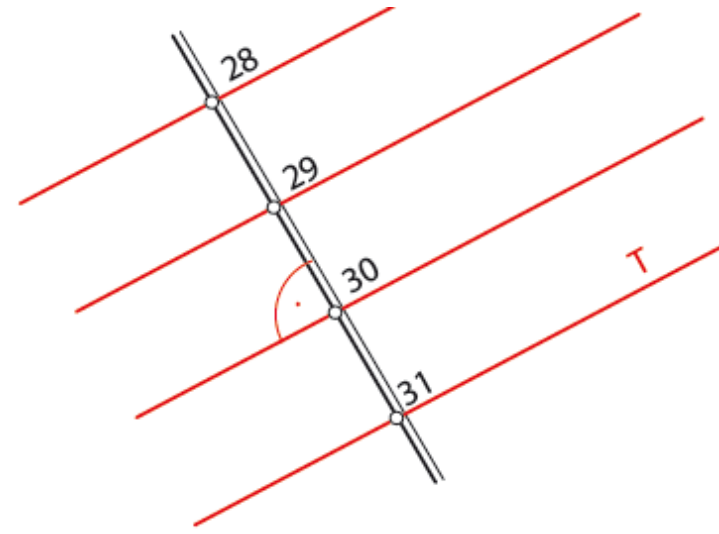
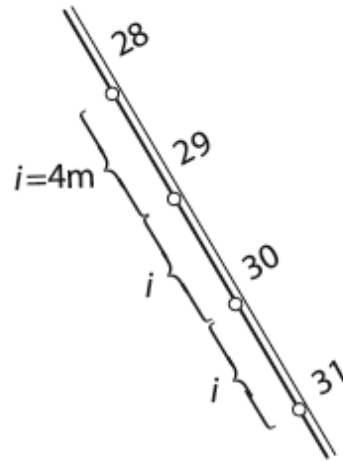
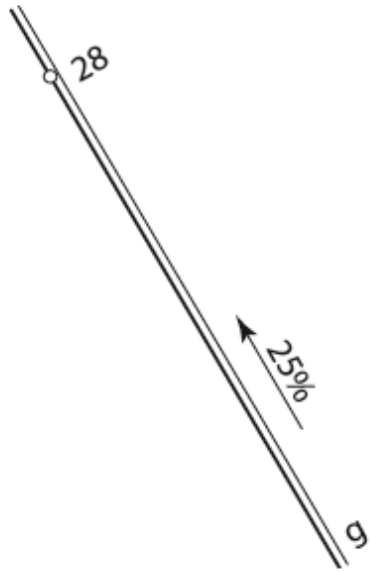

Prava pripada ravni

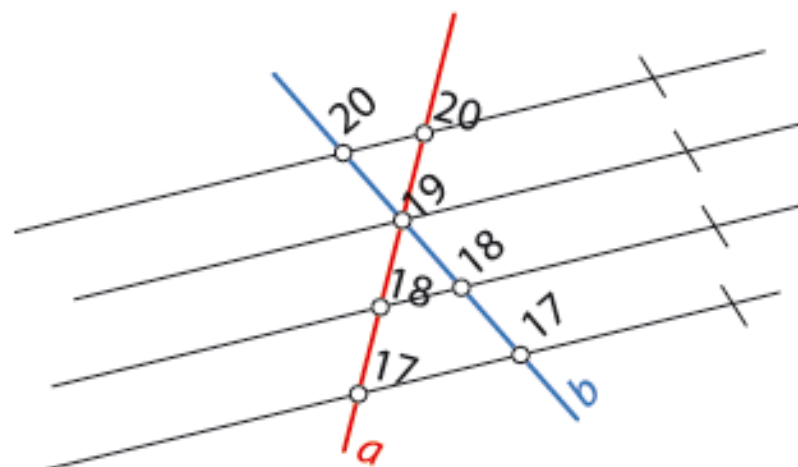
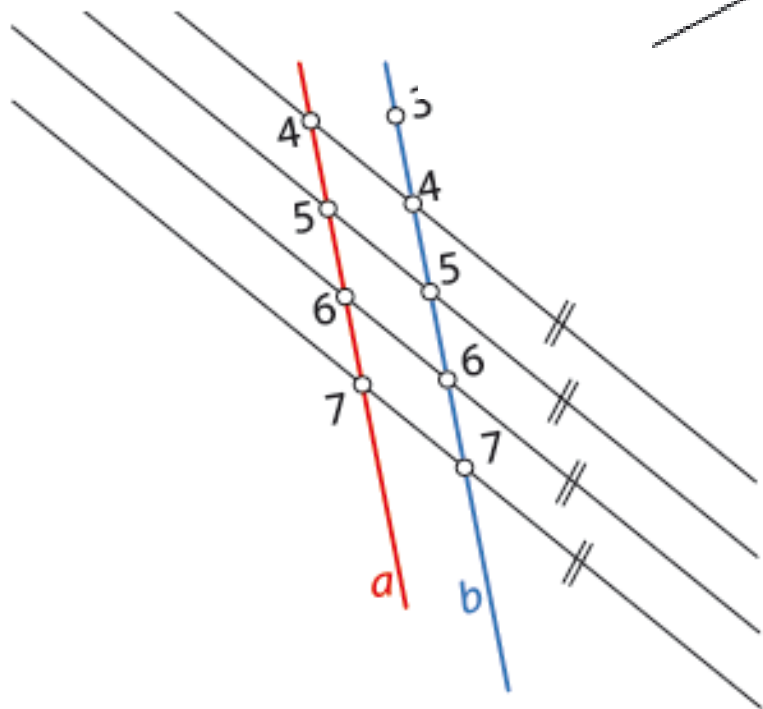
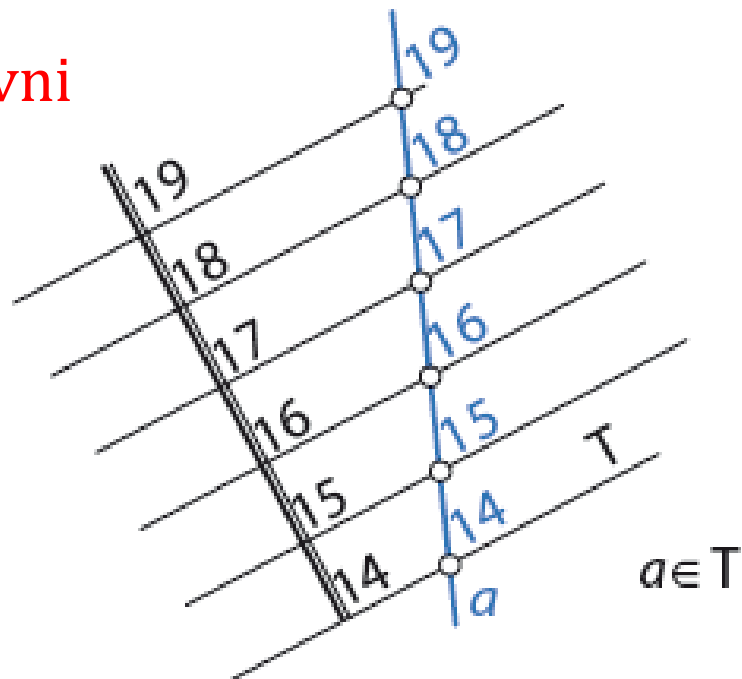

Dvije prave određuju ravan

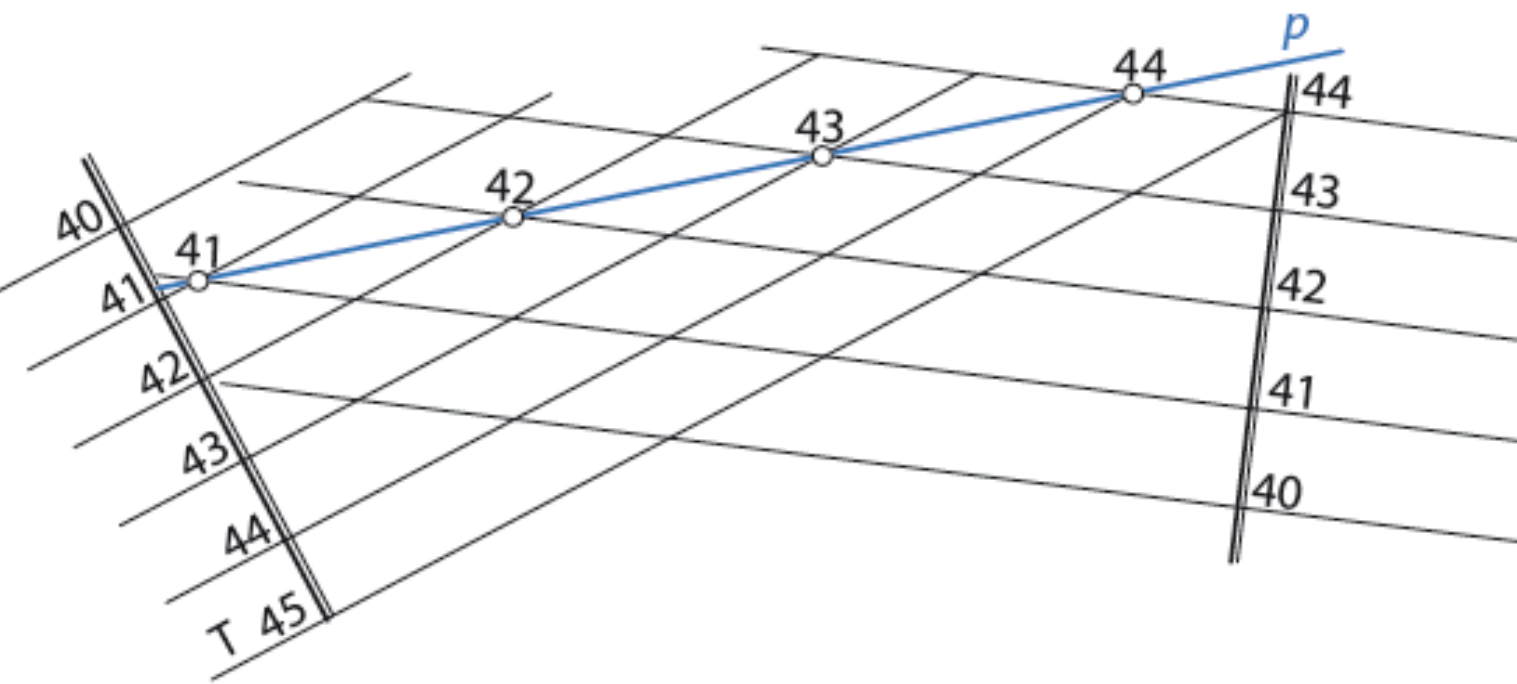

Presjek dvije ravni

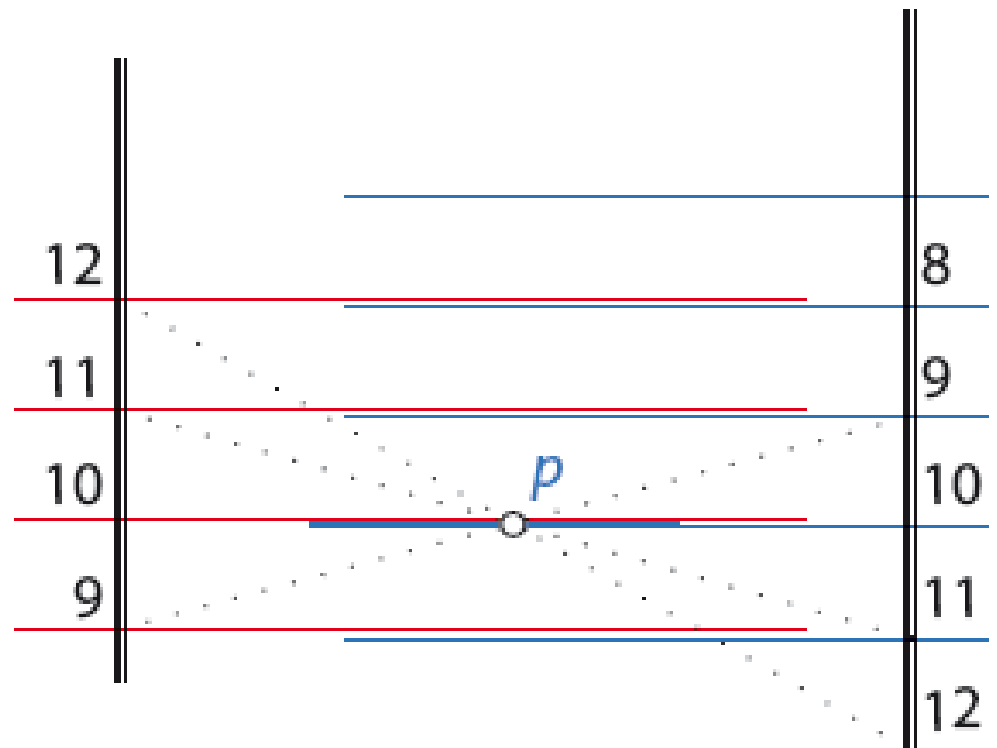

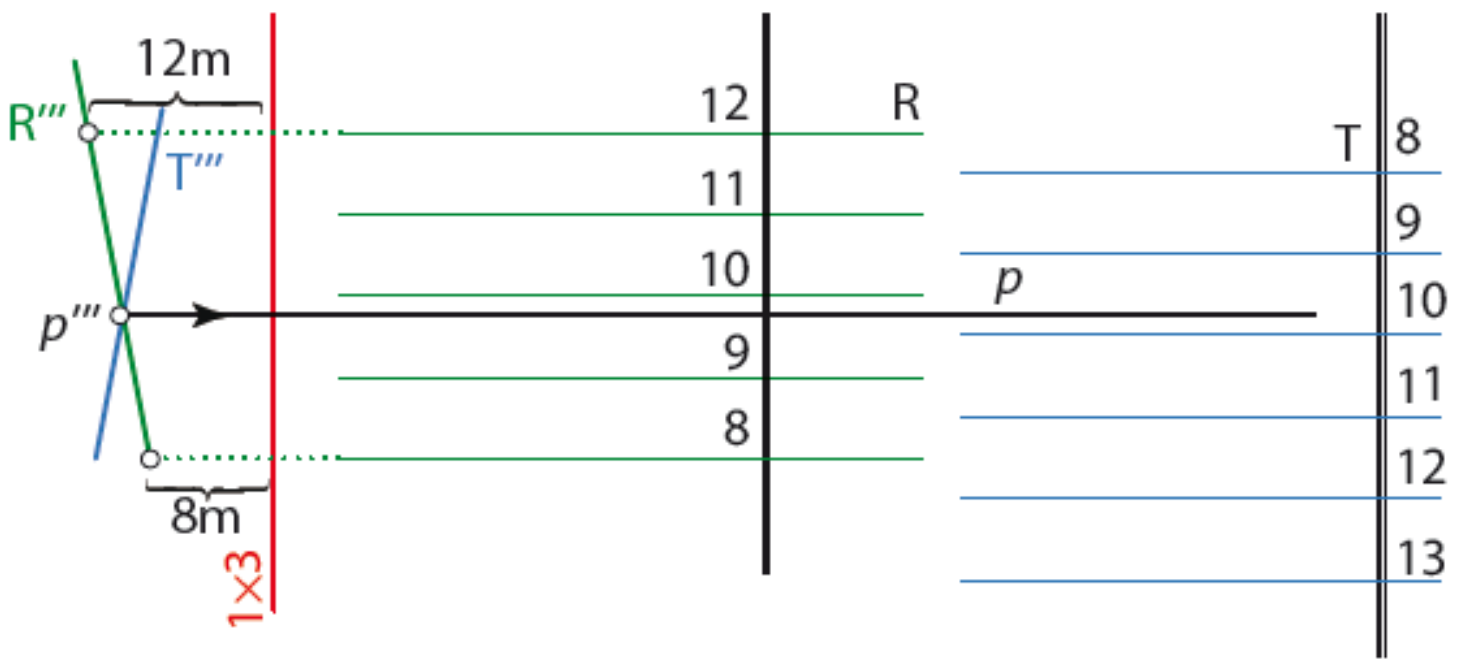
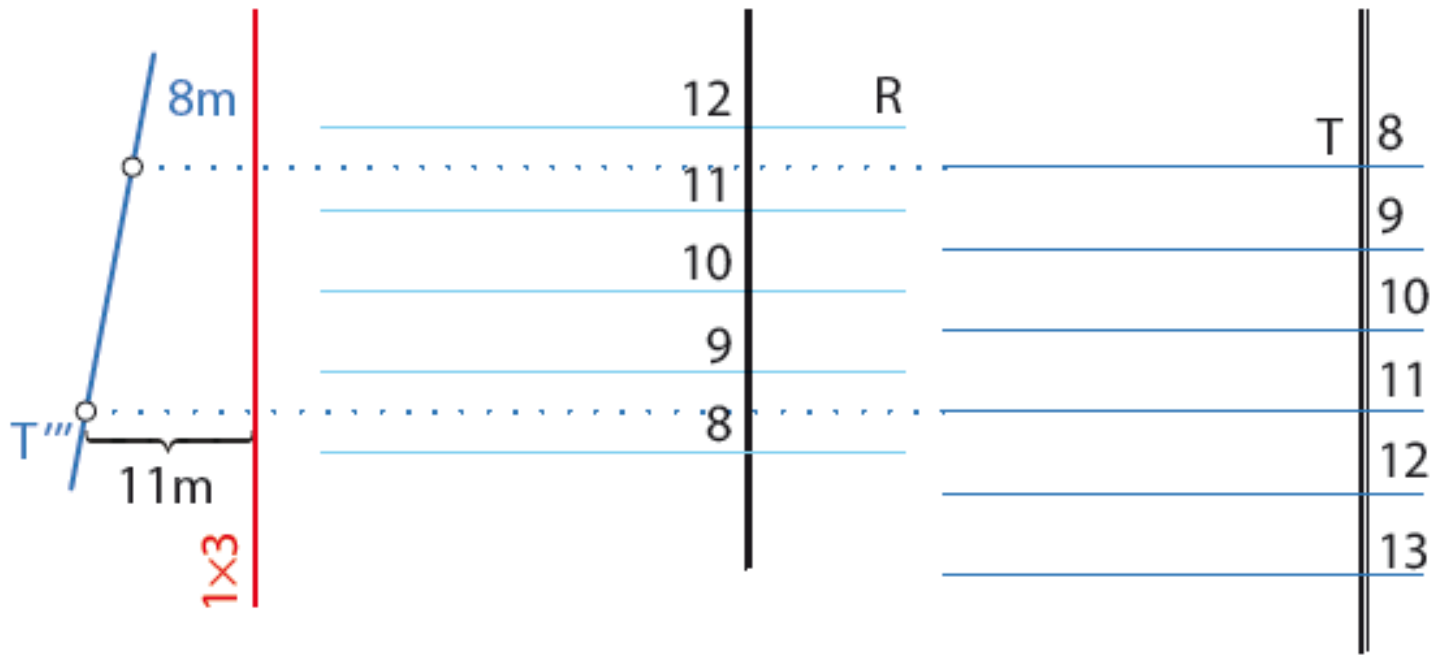

Presjek dvije ravni

TOPOGRAFSKA POVRŠ - TEREN

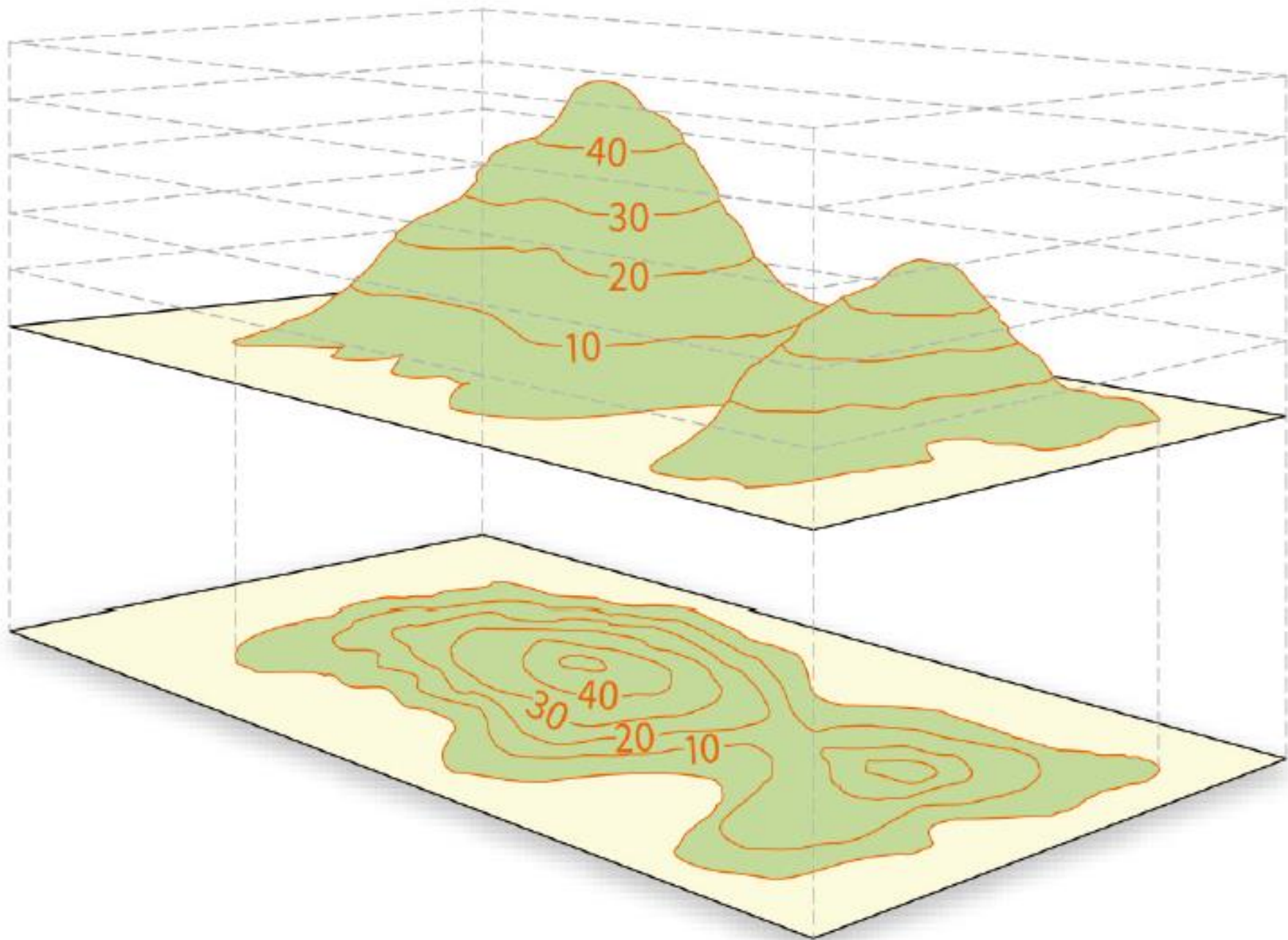

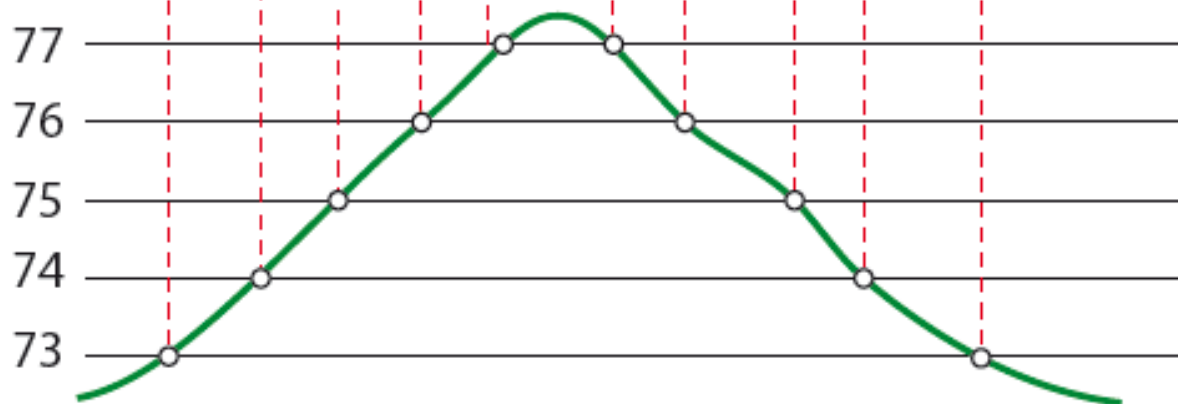
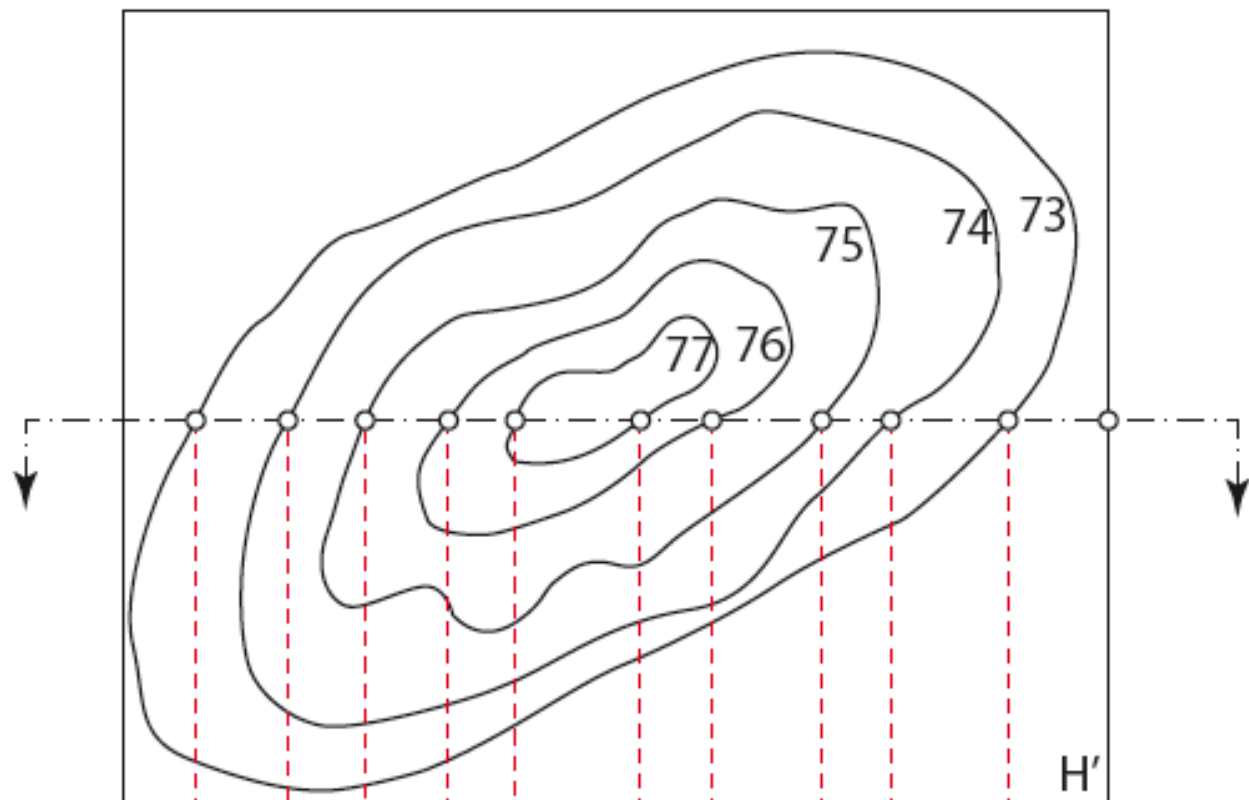



PLATO

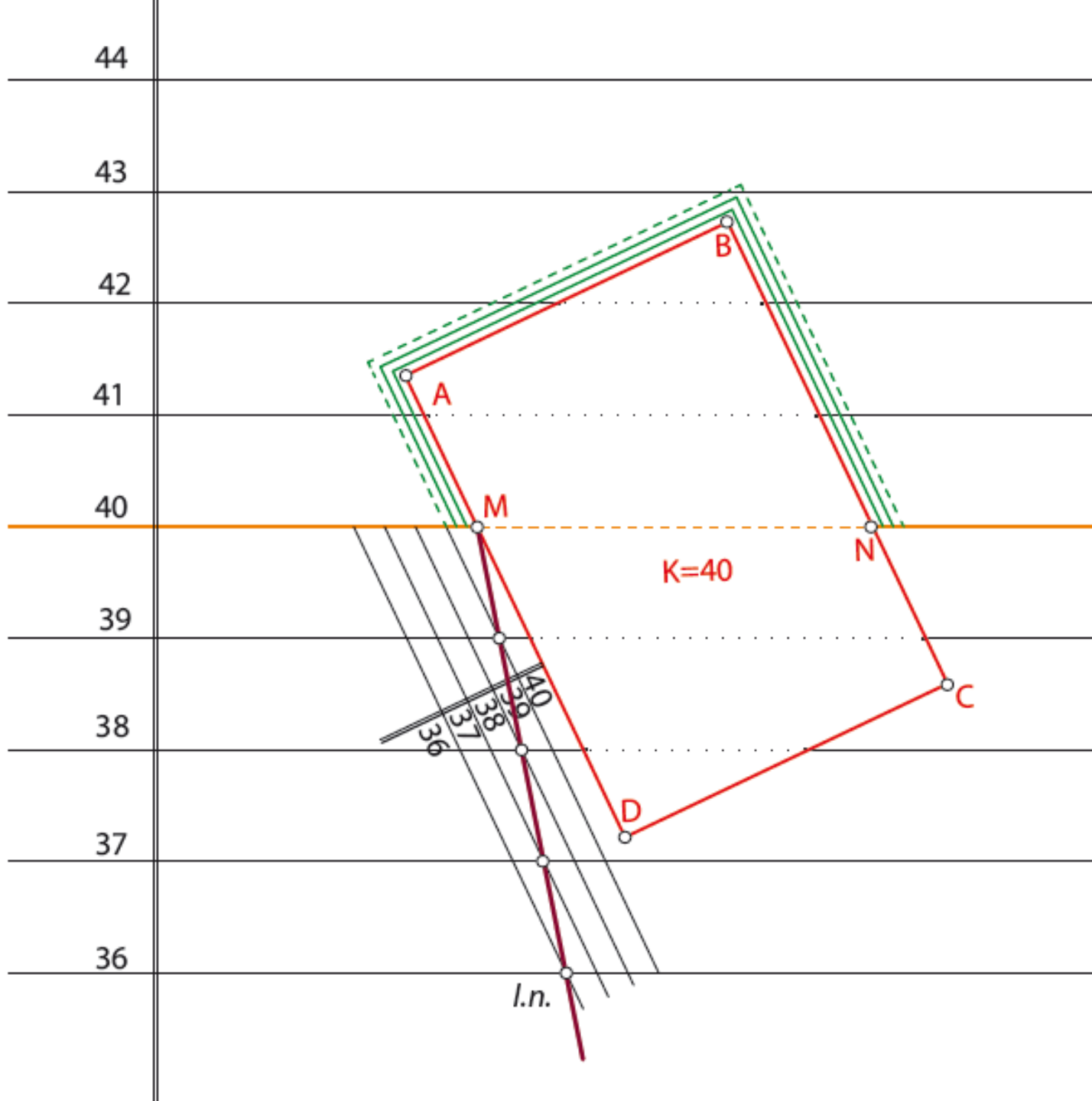

43

42

41

40

39

38

37

36

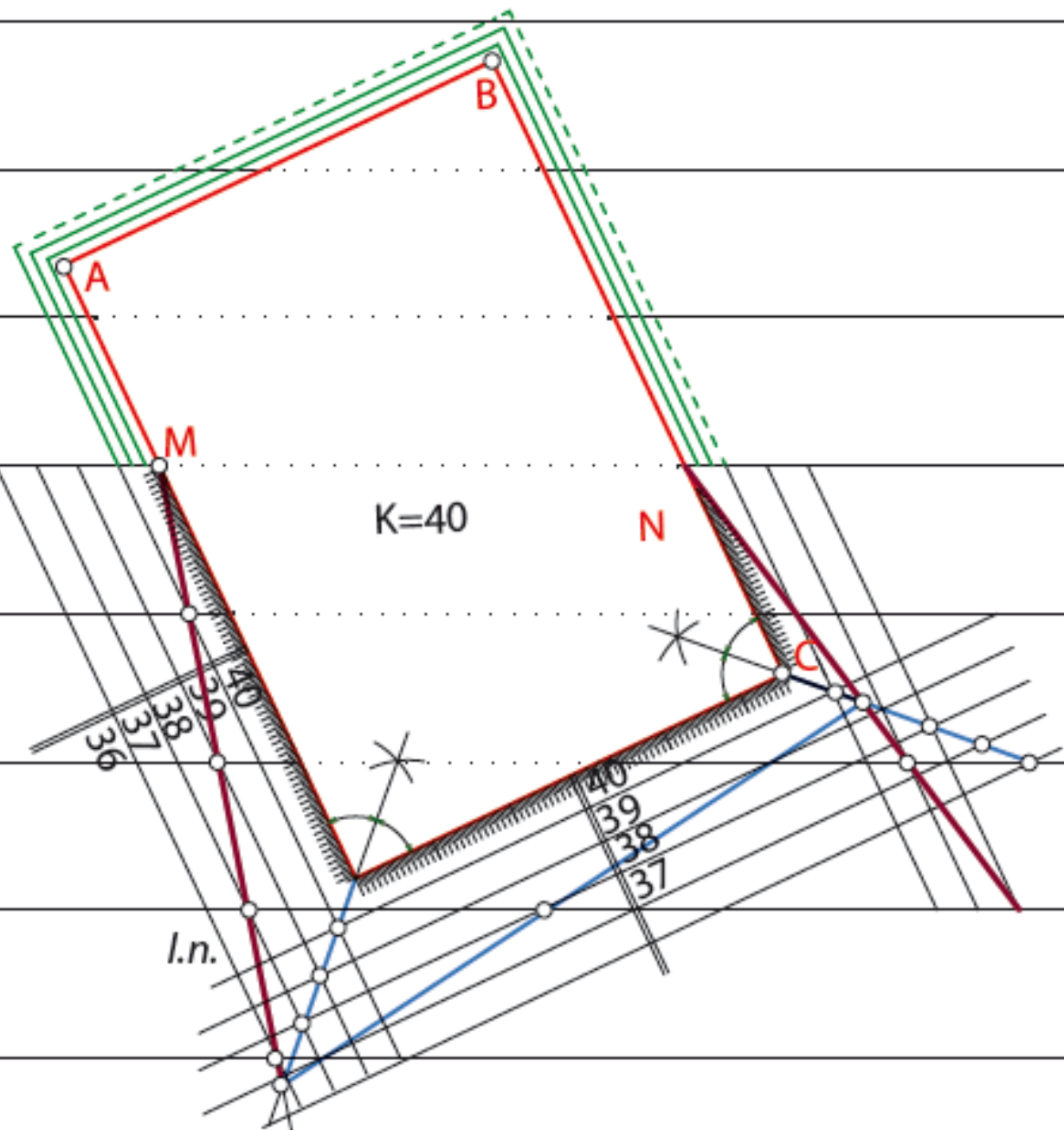

$K=40$

N

$l.n.$

36
37
38
39
40

40
39
38
37

43

42

41

40

39

38

37

36

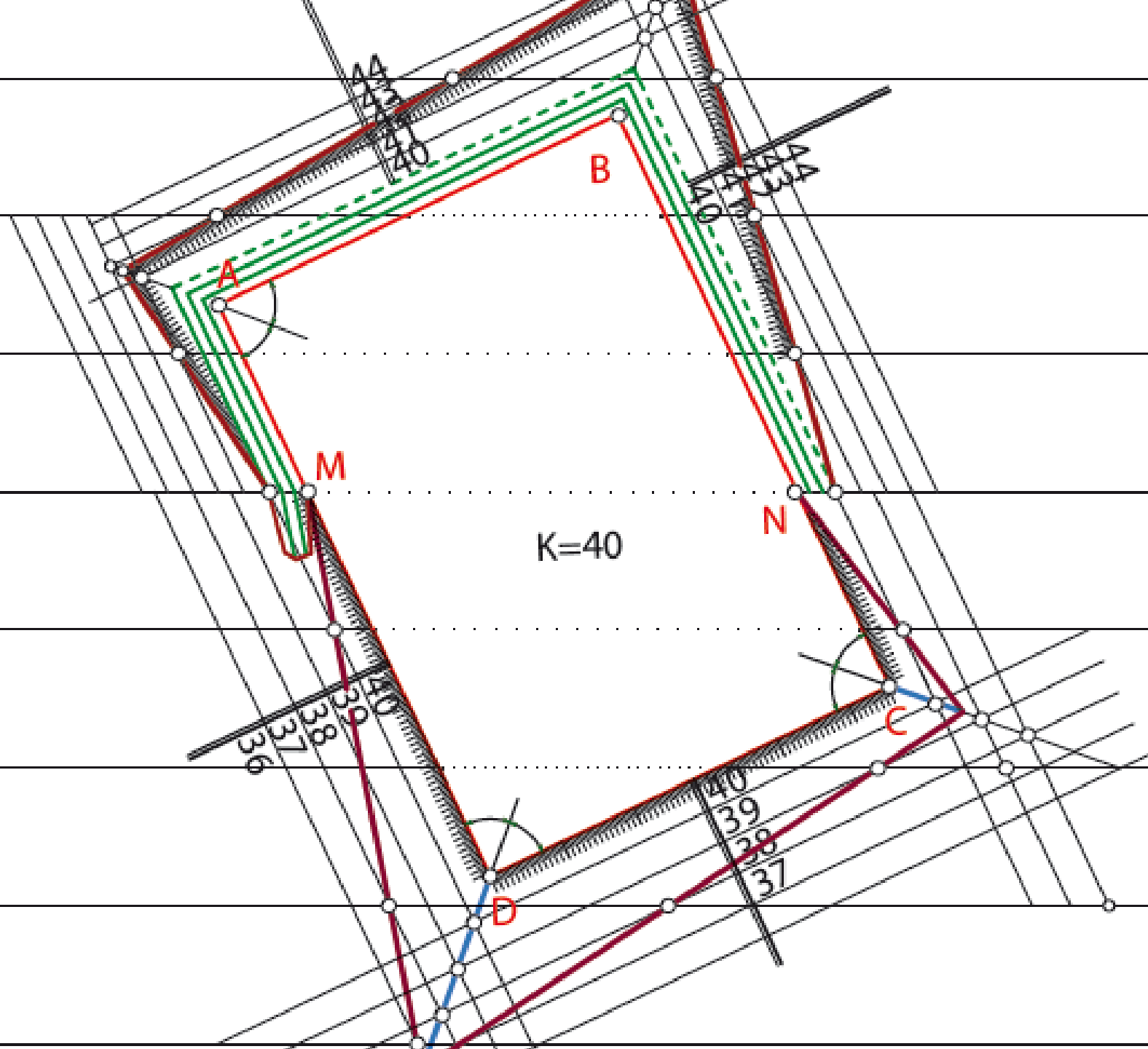



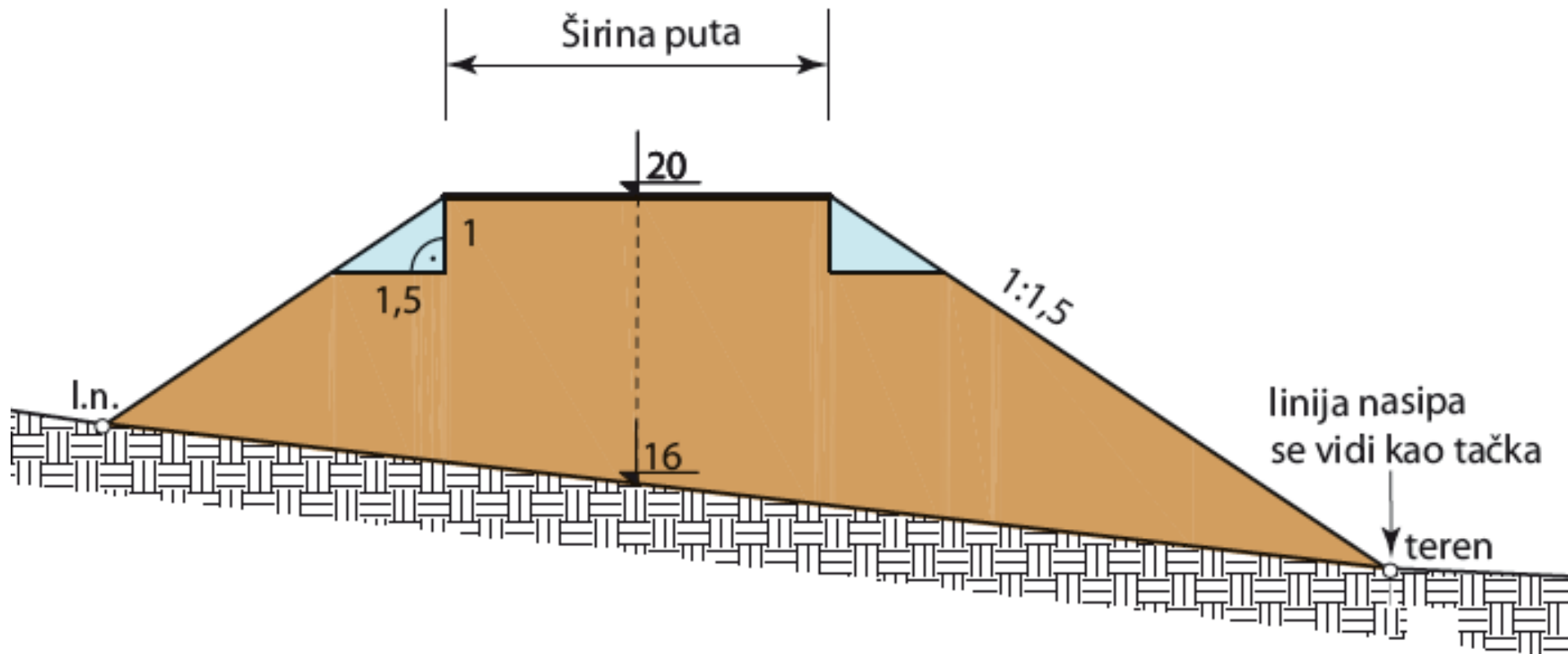



b)

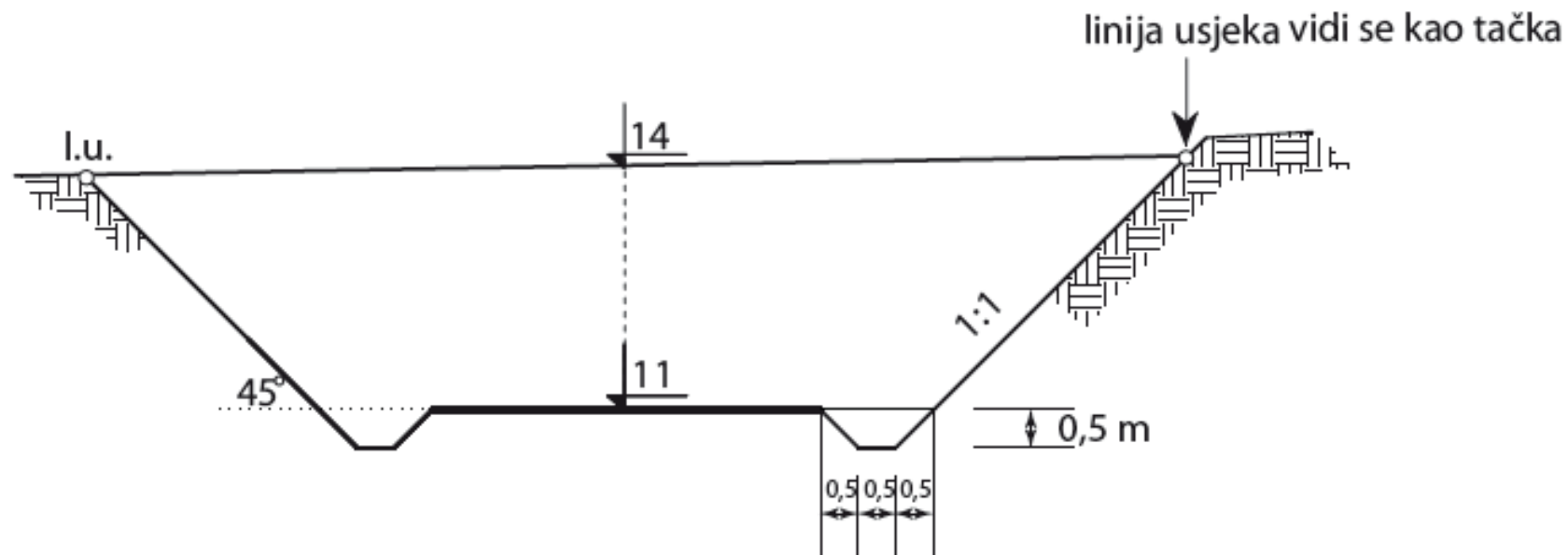

c)

teren

